

THREE-PHASE ELECTRICAL  
NETWORKS ANALYSER

C.A 8336  
**QUALI**STAR+











ENGLISH

User's manual

 **CHAUVIN®  
ARNOUX**  
CHAUVIN ARNOUX GROUP

Thank you for purchasing a **C.A 8336 three-phase electrical networks analyser (Qualistar+)**. To obtain the best service from your unit:

- **read** these operating instructions carefully,
- **comply** with the precautions for use.

	WARNING, risk of DANGER! The operator must refer to these instructions whenever this danger symbol appears.
	Equipment protected by double insulation.
	Earth.
	The product is declared recyclable following a life cycle analysis in accordance with standard ISO 14040.
	The CE marking indicates conformity with European directives, in particular LVD and EMC.
	Chauvin Arnoux has adopted an Eco-Design approach in order to design this appliance. Analysis of the complete lifecycle has enabled us to control and optimize the effects of the product on the environment. In particular this appliance exceeds regulation requirements with respect to recycling and reuse.
	The rubbish bin with a line through it indicates that, in the European Union, the product must undergo selective disposal in compliance with Directive WEEE 2002/96/EC. This equipment must not be treated as household waste.
	Kensington anti-theft system.
	USB socket.

#### Definition of measurement categories:

- Measurement category IV corresponds to measurements taken at the source of low-voltage installations.  
Example: power feeders, counters and protection devices.
- Measurement category III corresponds to measurements on building installations.  
Example: distribution panel, circuit-breakers, machines or fixed industrial devices.
- Measurement category II corresponds to measurements taken on circuits directly connected to low-voltage installations.  
Example: power supply to domestic electrical appliances and portable tools.

## PRECAUTIONS FOR USE

This device is compliant with safety standard IEC 61010-2-030, the leads are compliant with IEC 61010-031, and the current sensors are compliant with IEC 61010-2-032, for voltages up to 600 V in category IV or 1,000 V in category III. Failure to observe the safety instructions may result in electric shock, fire, explosion, and destruction of the instrument and of the installations.

- The operator and/or the responsible authority must carefully read and clearly understand the various precautions to be taken in use. Sound knowledge and a keen awareness of electrical hazards are essential when using this instrument.
- If you use this instrument other than as specified, the protection it provides may be compromised, thereby endangering you.
- Do not use the instrument on networks of which the voltage or category exceeds those mentioned.
- Do not use the instrument if it seems to be damaged, incomplete, or poorly closed.
- Do not use the instrument if the terminals or keyboard are wet. Dry it first.
- Before each use, check the condition of the insulation on the leads, housing, and accessories. Any item of which the insulation is deteriorated (even partially) must be set aside for repair or scrapping.
- Before using your device, check that it is perfectly dry. If it is wet, it must be thoroughly dried before being connected or being operated in any way.
- Use only the leads and accessories supplied. Using leads (or accessories) of a lower voltage or category reduces the voltage or category of the combined instrument + leads (or accessories) to that of the leads (or accessories).
- Use personal protection equipment systematically.
- Keep your hands away from the terminals of the device.
- When handling the leads, test probes, and crocodile clips, keep your fingers behind the physical guard.
- Use only the mains power adaptor and battery pack supplied by the manufacturer. They include specific safety features.
- Some current sensors must not be placed on or removed from bare conductors at hazardous voltages: refer to the sensor manual and comply with the handling instructions.

# CONTENTS

<b>1. GETTING STARTED</b> .....	<b>4</b>	<b>10. POWER AND ENERGY MODE</b> .....	<b>71</b>
1.1. Unpacking .....	4	10.1. 3L filter .....	71
1.2. Charging the battery .....	5	10.2. Filters L1, L2 and L3 .....	72
1.3. Choice of language .....	5	10.3. Filter $\Sigma$ .....	73
<b>2. DESCRIPTION OF THE DEVICE</b> .....	<b>6</b>	10.4. Starting energy metering .....	74
2.1. Functions .....	6	10.5. Disconnection of energy metering .....	75
2.2. Overall view .....	8	10.6. Reset of energy metering .....	75
2.3. On/Off switch .....	8	<b>11. SCREEN SNAPSHOT MODE</b> .....	<b>76</b>
2.4. Display .....	9	11.1. Screen snapshots .....	76
2.5. Keypad keys .....	10	11.2. Handling of screen snapshots .....	76
2.6. Connectors .....	12	<b>12. HELP KEY</b> .....	<b>77</b>
2.7. Power supply .....	12	<b>13. DATA EXPORT SOFTWARE</b> .....	<b>78</b>
2.8. The stand .....	13	<b>14. GENERAL SPECIFICATIONS</b> .....	<b>79</b>
2.9. Abbreviations .....	13	14.1. Environmental conditions .....	79
<b>3. USE</b> .....	<b>15</b>	14.2. Mechanical conditions .....	79
3.1. Start-up .....	15	14.3. Overvoltage categories per IEC 61010-1 .....	79
3.2. Configuration .....	15	14.4. Electromagnetic compatibility .....	80
3.3. Installation of leads .....	16	14.5. Power supply .....	80
3.4. Functions of the device .....	18	<b>15. FUNCTIONAL CHARACTERISTICS</b> .....	<b>82</b>
<b>4. CONFIGURATION</b> .....	<b>19</b>	15.1. Reference Conditions .....	82
4.1. Configuration menu .....	19	15.2. Nominal current according to type of sensor .....	82
4.2. Display language .....	19	15.3. Electrical characteristics .....	83
4.3. Date/Time .....	19	15.4. Class B under standard IEC 61000-4-30 .....	94
4.4. Display .....	20	<b>16. APPENDICES</b> .....	<b>95</b>
4.5. Calculation methods .....	21	16.1. Mathematical formulae .....	95
4.6. Connection .....	24	16.2. Distribution sources supported by the device .....	112
4.7. Sensors and ratios .....	28	16.3. Hysteresis .....	112
4.8. Capture Mode .....	29	16.4. Minimum scale values for waveforms and minimum RMS values .....	112
4.9. Trend mode .....	31	16.5. Four-quadrant diagram .....	113
4.10. Mode Alarm mode .....	33	16.6. Mechanism for triggering transient captures .....	113
4.11. Erase memory .....	34	16.7. Capture conditions in Inrush Current mode .....	113
4.12. About .....	35	16.8. Glossary .....	114
<b>5. WAVEFORM CAPTURE</b> .....	<b>36</b>	<b>17. MAINTENANCE</b> .....	<b>117</b>
5.1. Transient mode .....	36	17.1. Cleaning the casing .....	117
5.2. Inrush current mode .....	39	17.2. Maintenance of sensors .....	117
<b>6. HARMONIC</b> .....	<b>44</b>	17.3. Replacing the battery .....	117
6.1. Phase-to-neutral voltage .....	44	17.4. Replacing the screen film .....	118
6.2. Current .....	45	17.5. Memory card .....	119
6.3. Apparent power .....	46	17.6. Metrological check .....	120
6.4. Phase-to-phase voltage .....	47	17.7. Repair .....	120
6.5. Expert mode .....	48	17.8. Updating of the internal software .....	120
<b>7. WAVEFORM</b> .....	<b>50</b>	<b>18. WARRANTY</b> .....	<b>120</b>
7.1. Measurement of true RMS value .....	50	<b>19. TO ORDER</b> .....	<b>121</b>
7.2. Measurement of total harmonic distortion .....	52	19.1. C.A 8336 three-phase electrical networks analyser .....	121
7.3. Measurement of the peak factor .....	53	19.2. Accessories .....	121
7.4. Measurement of extreme and mean voltage and current .....	54	19.3. Spare parts .....	121
7.5. Simultaneous display .....	56		
7.6. Display of Fresnel diagram .....	58		
<b>8. ALARM MODE</b> .....	<b>60</b>		
8.1. Alarm mode configuration .....	60		
8.2. Programming an alarm campaign .....	60		
8.3. Display of the list of campaigns .....	61		
8.4. Display of list of alarms .....	61		
8.5. Deleting an alarm campaign .....	62		
8.6. Erasing all alarm campaigns .....	62		
<b>9. TREND MODE</b> .....	<b>63</b>		
9.1. Programming and starting recording .....	63		
9.2. Trend mode configuration .....	63		
9.3. Viewing the recording list .....	64		
9.4. Deleting recordings .....	64		
9.5. Viewing the records .....	64		

# 1. GETTING STARTED

## 1.1. UNPACKING

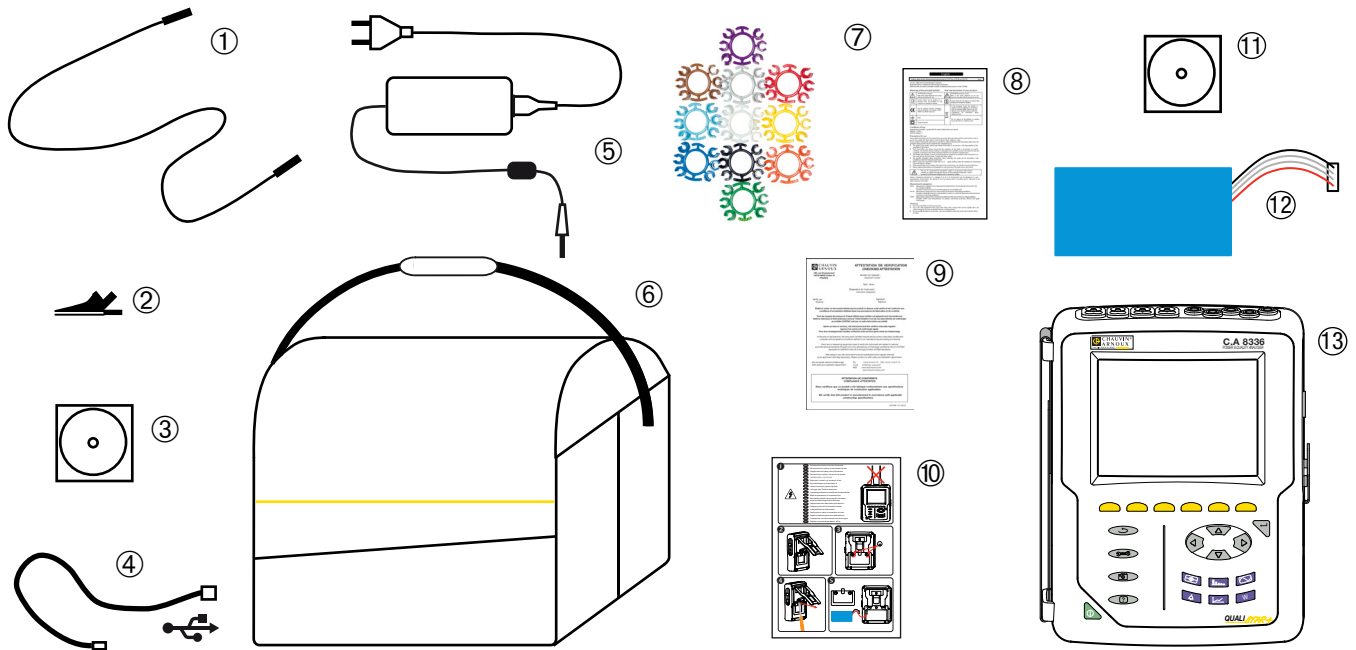

No.	Designation	Quantity
①	Safety cables, black, banana-banana, straight-straight attached by a Velcro tie.	5
②	Black crocodile clips.	5
③	User's manual on CD-ROM.	1
④	Type A-B USB cord.	1
⑤	Specific mains power unit and mains cord.	1
⑥	No. 22 carrying bag	1
⑦	Sets of inserts and rings for marking the leads and current sensors according to phase.	12
⑧	Multilingual safety sheet.	1
⑨	Checking attestation.	1
⑩	Quick start guide.	1
⑪	Power Analyser Transfer (PAT2) software on CD-ROM.	1
⑫	Battery.	1
⑬	C.A 8336 with or without current sensor depending on the order.	1

## 1.2. CHARGING THE BATTERY

Install the battery in the device (see quick start guide or § 17.3). Before the first use, start by fully charging the battery.

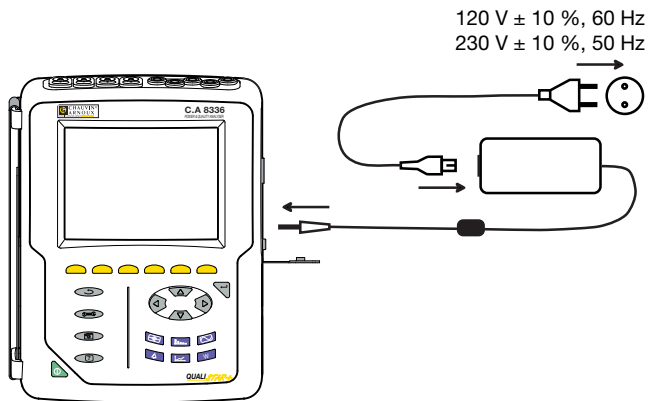

Remove the cover from the receptacle and connect the plug of the specific power supply unit to the device. Connect the mains cord to the power supply unit and to mains.

The button  lights; it will go out only when the plug is disconnected.



When the battery is fully discharged, charging takes approximately 5 hours.

## 1.3. CHOICE OF LANGUAGE

Before using the device, first choose the language in which you want the device to display its messages.



Press the green button to switch the device on.



Press the Configuration key.

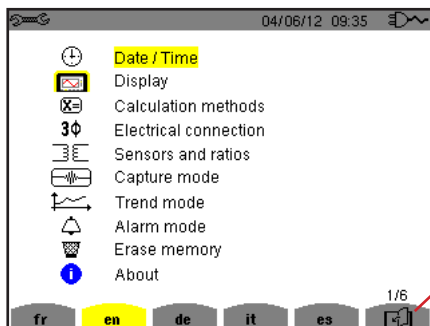

Press the yellow key on the device corresponding to the desired language.

This key is used to go to the next page.

Figure 8: Configuration screen

## 2. DESCRIPTION OF THE DEVICE

### 2.1. FUNCTIONS

The C.A. 8336 (Qualistar+) is a three-phase network analyzer with colour graphic display and built-in rechargeable battery.

It plays three roles, and can be used:

- to measure the RMS values, powers, and perturbations of electric distribution networks.
- to deliver a snapshot of the principal characteristics of a three-phase network
- to track the variations of various parameters over time.

The measurement uncertainty of the device is better than 1% (not counting the uncertainties due to the current sensors). The device is also very flexible, with a choice of sensors allowing measurements ranging from a few milliamperes (MN93A) to several kiloamperes (AmpFLEX™).

The device is compact and impact resistant.

The ergonomics and simplicity of its interface make using it pleasant.

The C.A 8336 is intended for the technicians and engineers of electrical installation and network inspection and maintenance teams.

#### 2.1.1. MEASUREMENT FUNCTIONS

The principal measurements made are:

- The RMS values of AC voltages up to 1000 V between terminals. By using the ratios, the device can measure voltages up to hundreds of gigavolts.
- The RMS values of AC currents up to 10,000 amperes (neutral included). By using the ratios, the device can measure currents up to hundreds of kiloamperes.
- The DC components of voltages and currents (neutral included).
- Minimum and maximum half-cycle RMS voltage and current values (excluding neutral).
- Peak voltage and current values (neutral included).
- The frequency of 50 Hz and 60 Hz networks.
- Current and voltage peak factors (neutral included).
- Calculation of the harmonic loss factor (FHL), application to transformers in the presence of harmonic currents.
- Calculation of the K factor (KF), application to transformers in the presence of harmonic currents.
- Measurement of total harmonic distortion with respect to the fundamental (THD in % f) of the current and of the voltages (excluding neutral).
- Measurement of the total harmonic distortion with respect to the RMS AC value (THD in % r) for the current and the voltages (neutral included)
- Active, reactive (capacitive and inductive), non-active, distortion, and apparent power, by phase and cumulative (excluding neutral).
- Power factor (PF) and displacement factor (DPF or  $\cos \Phi$ ) (excluding neutral).
- Measurement of the RMS distortion value (d) for the current and the voltages (excluding neutral).
- Short-term voltage flicker (PST) (excluding neutral).
- Measurement of the long-term flicker of the voltages (PLT) (excluding neutral).
- Active, reactive (capacitive and inductive), non-active, distortion, and apparent energy (excluding neutral).
- Current and voltage harmonics (excluding neutral) up to order 50: RMS value, percentage referred to the fundamental, (%f) (excluding neutral), or the total RMS value (%r), minimum and maximum and sequence harmonics.
- Apparent harmonic power up to order 50 (excluding neutral): percentages referred to the fundamental apparent power (%f) or the total apparent power (%r), minimum and maximum of a rank.
- Inrush currents, starting of motors.

### 2.1.2. DISPLAY FUNCTIONS

- Display of waveforms (voltages and currents).
- Display of frequency bar chart (voltages and currents).
- Inrush Current function: displays parameters useful for study of the starting of a motor.
  - Instantaneous current and voltage at the instant designated by the cursor.
  - Maximum instantaneous absolute value of the current and of the voltage (over the entire starting time).
  - RMS value of the half-cycle (or lobe) of the current and voltage (excluding neutral) on which the cursor is positioned.
  - Maximum half-cycle RMS current (over the entire starting time).
  - Instantaneous network frequency at the instant designated by the cursor.
  - Maximum, mean, and minimum network frequencies (over the entire starting time).
  - Time at which starting of motor commenced.
- Screen captures (50 maximum).
- Transients function. Detection and recording of transients (up to 210) between user-defined start and stop dates and times. Recording of 4 complete cycles (one before the triggering event and three after) in the 8 acquisition channels.
- Trend recording (data logging) function. 2GB memory with date-stamping and user-defined start and stop dates for recording, with a maximum of 100 recordings. Display, in bar chart or curve form, of the means of many parameters vs. time, with or without minima and maxima.
- Alarm function. List of recorded alarms (up to 16,362) exceeding thresholds defined in the configuration menu. User-defined alarm monitoring start and stop times.

### 2.1.3. CONFIGURATION FUNCTIONS

- Date and time setting.
- Screen brightness setting.
- Choice of curve colours.
- Choice of management of switching off of the screen.
- Choice of display in night mode.
- Choice of calculation methods (non-active quantities broken down or not, choice of the unit of energy, choice of the coefficients of calculation of the K factor, choice of reference for the level of harmonics, PLT calculation (sliding or not).
- Choice of distribution system (single-phase, two-phase, three-phase with or without neutral) and of the connection method (standard, 2-element method or 2½-element method).
- Configuration of recording, alarms, inrush currents, and transients.
- Erasure of data (total or partial).
- Display of software and hardware version numbers.
- Choice of language.
- Display of current sensors detected not detected, not managed, simulated or impossible to simulate (2-element connection method) . Setting of voltage and current ratio, of the transduction ratios and of the sensitivity.

## 2.2. OVERALL VIEW

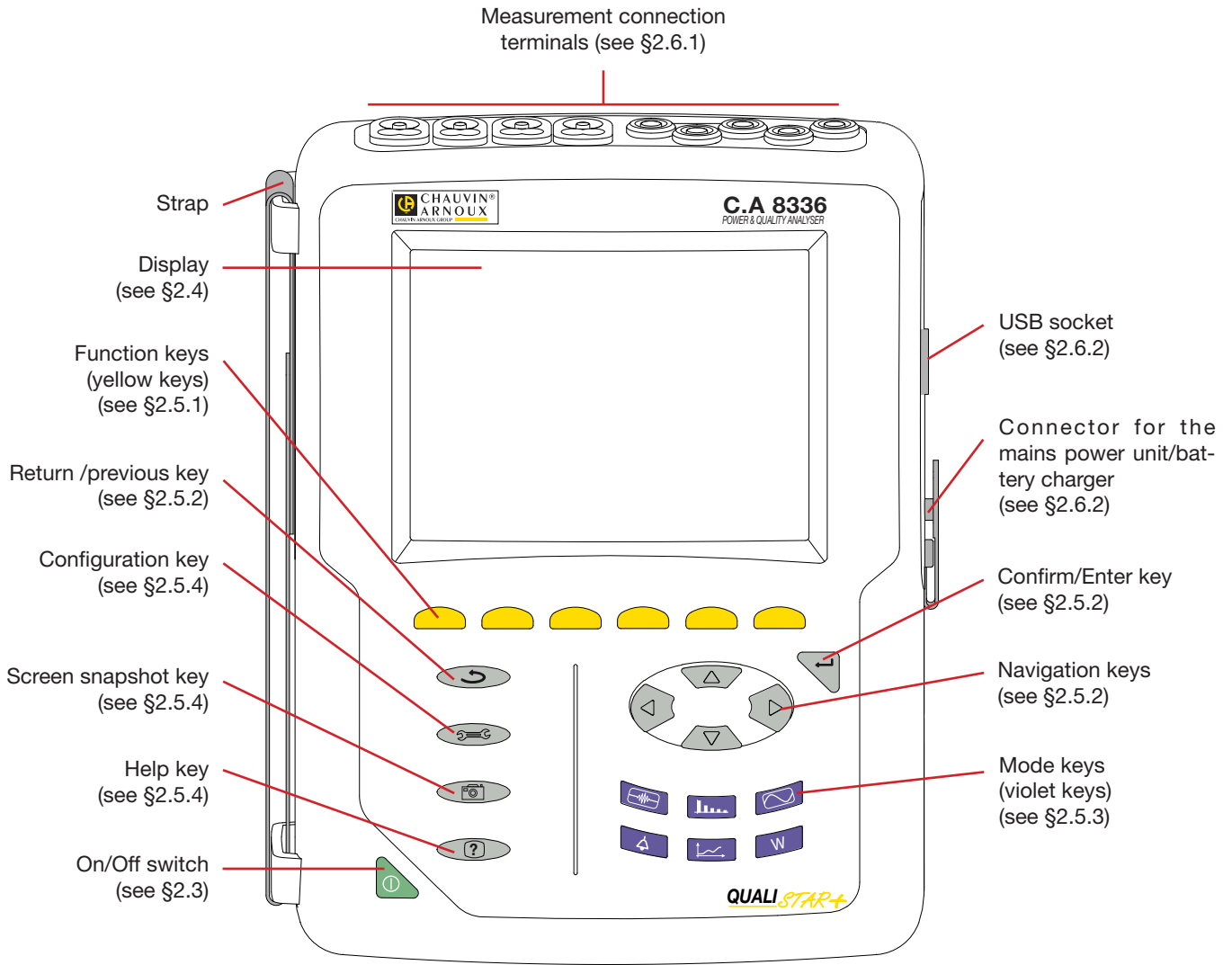

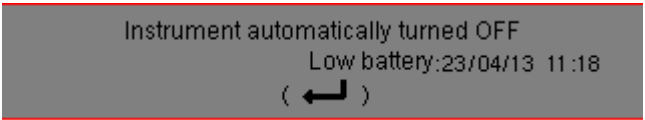
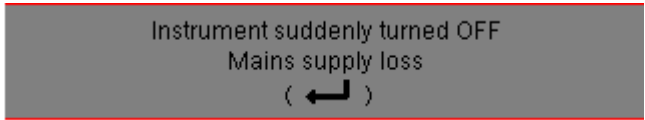



Figure 1: Overall view of Qualistar+

## 2.3. ON/OFF SWITCH

The device can operate either on its battery or on mains power. Pressing the  button powers up the device. . If the device is shut off suddenly (line power outage in the absence of the battery) or automatically (battery low), an information message is displayed when it is next started up.



Pressing the  switch again turns the device off. If the device is recording, metering energy, or searching for transients, alarms, and/or inrush current acquisition, it requests confirmation.

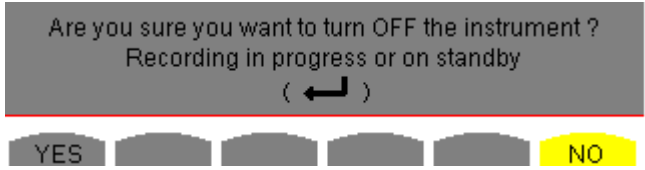

- Select **Yes** or **No** on the corresponding yellow keys, then press the  key to validate.
- If **No** is selected, recording will continue.
  - If **Yes** is selected, the data recorded until that point are finalized and the device is turned off.



## 2.4. DISPLAY

### 2.4.1. PRESENTATION

The backlit 320x240 (1/4 VGA) pixel graphic TFT displays all measurements with their curves, the parameters of the unit, the curves selected, the instantaneous values of the signals, and the type of measurement selected. When the device is powered up, it automatically displays the *Waveform* screen. Information about this screen can be found in §7.

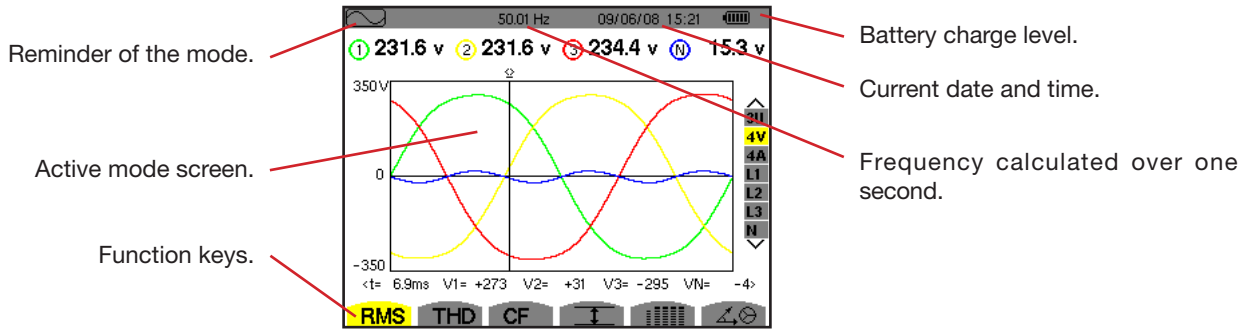

Figure 2: example of a display screen

The management of switching off of the screen is chosen by the user in the Display Configuration Mode menu (see §4.4.3).

### 2.4.2. THE FUNCTION KEY ICONS

The display uses the following icons for the yellow function keys:

Icons	Designation
V	Phase-to-neutral voltage mode.
A	Phase-to-neutral current mode.
S	Power mode.
U	Phase-to-phase voltage mode.
var	Management of the breakdown of the non-active quantities.
Wh	Choice of unit of energy.
FK	Choice of coefficients of the K factor.
%f-%r	Choice of reference for the level of harmonics of the phases.
PLT	Management of the long-term flicker calculation mode.
CF	Display of the peak factors and of the curves.
RMS	Display of the RMS values and of the curves.
PEAK	Display of the PEAK values and of the curves.
THD	Display of the level of harmonic distortion and of the curves
PF...	Display of PF, cos $\Phi$ (DPF), tan $\Phi$ , and $\Phi$ .
W...	Display of powers and of the associated quantities (PF, cos $\Phi$ , DPF, tan $\Phi$ and $\Phi_{VA}$ ).
Wh...	Display of the energy meters.
[Σ]	Activation and de-activation of the energy calculation.

Icons	Designation
	Zoom in.
	Zoom out.
	Management of the contrast.
	Choice of colours of the measurement channels.
	Management of the switching off of the screen
	Display in night mode.
	Recording programming mode.
	Recording look-up mode.
	Start of recording.
	Rapid programming and start of recording.
	Disconnection of recording.
	Shut down function in progress prompt.
	Bin for deletions of elements.
	Shortcut to the recording parameterizing mode
	Activate/deactivate selection of the transients list display filter.

Icons	Designation
	Display of mean values and extrema.
	Move the cursor to the first occurrence of the maximum phase-to-neutral voltage.
	Move the cursor to the first occurrence of the minimum phase-to-neutral voltage.
	Move the cursor to the first occurrence of the maximum phase-to-phase voltage.
	Move the cursor to the first occurrence of the minimum phase-to-phase voltage.
	Move the cursor to the first occurrence of the maximum current.
	Move the cursor to the first occurrence of the minimum current.
	Move the cursor to the first occurrence of the maximum instantaneous frequency.
	Move the cursor to the first occurrence of the minimum instantaneous frequency.
	Move the cursor to the first occurrence of the maximum of the measurement displayed.
	Move the cursor to the first occurrence of the minimum of the measurement displayed.
	Simultaneous display of all voltage and current measurements (RMS, DC, THD, CF, PST, PLT, FHL, FK).

Icons	Designation
	Select all items.
	Unselect all items.
	Transient mode.
	Inrush current mode.
	Display of Fresnel diagram of the signals.
	Move cursor to transient triggering time.
	Move the cursor to one signal period before the triggering date of the transient.
	Energies consumed by the load.
	Energies generated by the load.
	Page screen 1 of the help function.
	Page screen 2 of the help function.
	Page screen 3 of the help function.
	Page screen 4 of the help function.
	Previous configuration.
	Next configuration.
	Previous page screen.
	Next page screen.

## 2.5. KEYPAD KEYS

### 2.5.1. FUNCTION KEYS (YELLOW KEYS)

These 6 keys activate the function or tool represented by the corresponding icon on the screen.







### 2.5.2. NAVIGATION KEYS

A block of 4 arrow keys, a select key and a return key are used for navigation in the menus.



Item	Function
	Up direction or navigation key.
	Down direction or navigation key.
	Right direction or navigation key.
	Left direction or navigation key.
	Confirms the selection.
	Return key.

### 2.5.3. MODE KEYS (VIOLET KEYS)

These give access to specific modes:

Item	Function	See
	Waveform acquisition mode, with two sub-modes: transients mode (blackouts, interference, etc.) and inrush current mode (starting of motor).	§ 5
	Harmonic curves display mode: representation of voltage, current, and power harmonics, order by order; determination of harmonic currents produced by nonlinear loads, analysis of problems caused by harmonics according to their order (overheating of neutrals, conductors, motors, etc.).	§ 6
	Display of voltage and current waveforms, display of minima and maxima of summary tables, determination of phase rotation.	§ 7
	Alarm mode: list of recorded alarms exceeding the thresholds programmed in the configuration; recording of network blackouts with half-cycle resolution (Vrms, Arms, Urms), determination of energy consumption overshoots, monitoring of compliance with a power supply quality contract.	§ 8
	Trend mode: recording of the parameters selected in the Configuration menu.	§ 9
	Display of power and energy measurements	§ 10

Three keys are real-time mode keys: ,  and .



In each of these modes, the coloured circles on a white ground , in which the channel numbers or types are entered, are indicators of saturation: the ground of the circle is coloured when the channel measured is potentially full .

When the identification disc corresponds to a simulated channel (for example in 4-wire three-phase with selection V1V2, 2½-element method, or in 3-wire three-phase with selection A1A2, 2-element method; see connections in §4.6), this channel is potentially full if at least one channel used in calculating it is potentially full.

Similarly, if the saturation disc corresponds to a phase-to-phase voltage channel, it is potentially full if at least one of the phase-to-neutral voltage channels used in calculating it is potentially full.

### 2.5.4. OTHER KEYS

The other keys have the following functions:

Item	Function	See
	Configuration key.	§ 4
	Snapshot of current screen and retrieval of screens already stored.	§ 11
	Help key: provides information about the functions and the symbols used for the current display mode.	§ 12

## 2.6. CONNECTORS

### 2.6.1. CONNECTION TERMINALS

Located on the top of the device, these connectors are distributed as follows:

4 current input terminals for current sensors (MN clamp, C clamp, AmpFLEX™, PAC clamp, E3N clamp, etc.).

5 voltage input terminals.

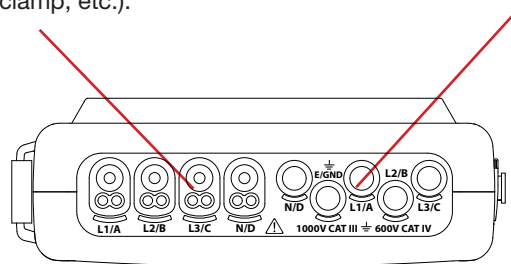

Figure 3: the connection terminals

### 2.6.2. SIDE CONNECTORS

Located on the right side of the device, these connectors are used as follows:

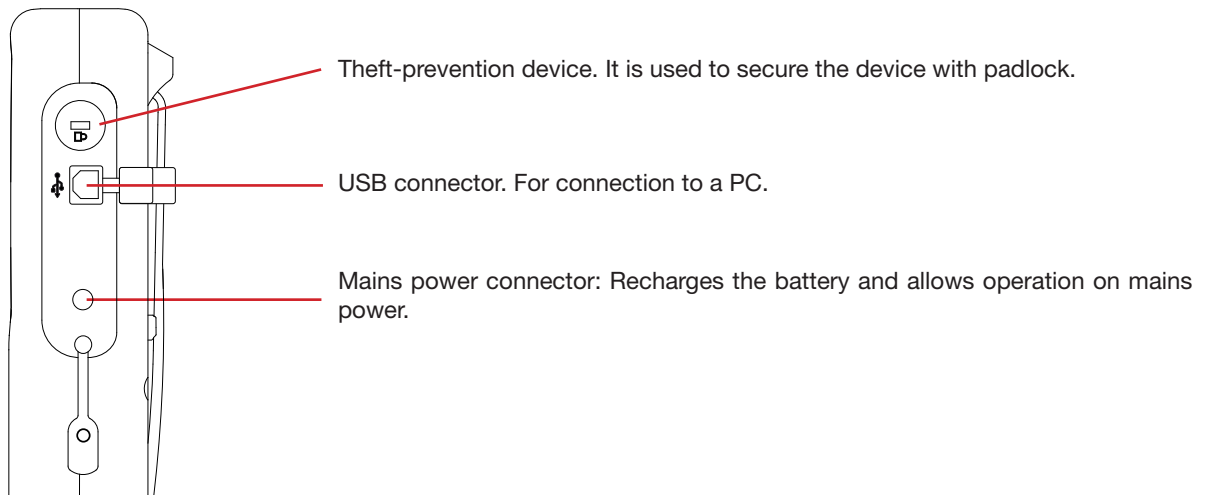

Figure 4: the side connectors

## 2.7. POWER SUPPLY

The battery icon in the top right corner of the screen shows the battery level. The number of bars is proportional to the charge level.

- Battery charged.
- Low battery.
- Mobile bars: battery charging.
- A red bar: the condition of the battery is unknown because it has never been fully charged.
- The device is connected to mains without the battery.

When the battery level is too low, the following message is displayed:

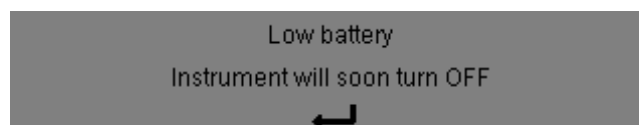

Press ← to confirm the information. If you do not connect the device to mains, it switches itself off one minute after this message. It is therefore necessary to start charging it as soon as possible.

## 2.8. THE STAND

A retractable stand on the back of the Qualistar+ can be used to hold the device in a tilted position.

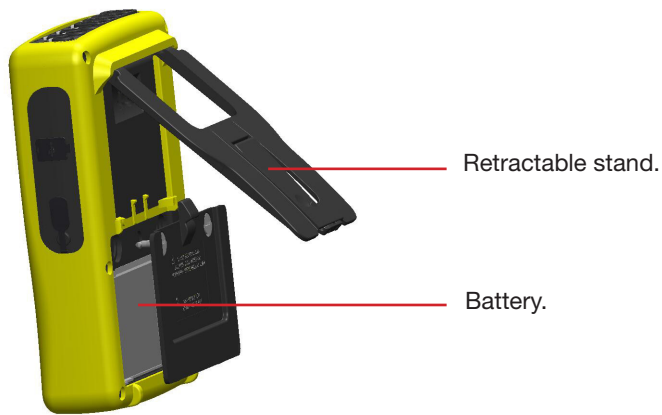

Figure 5: stand and battery compartment cover

## 2.9. ABBREVIATIONS

Prefixes of International System (SI) units

Prefix	Symbol	Multiplies by
milli	m	$10^{-3}$
kilo	k	$10^3$
Mega	M	$10^6$
Giga	G	$10^9$
Tera	T	$10^{12}$
Peta	P	$10^{15}$
Exa	E	$10^{18}$

Meanings of the symbols and abbreviations used:

Symbol	Designation
$\approx$	AC and DC components.
$\sim$	AC component only.
$\equiv$	DC component only.
$\overset{\oplus}{\parallel}$	Inductive phase shift.
$\overset{\ominus}{\parallel}$	Capacitive phase shift.
$^{\circ}$	Degree.
-.+	Expert mode.
	Absolute value.
$\Sigma$	Sum of values.
%	Percentage.
%f	Fundamental value as reference
%r	Total value as reference
$\Phi_{VA}$ or $\Phi_{UA}$	Phase shift of voltage with respect to current.
<b>A</b>	Current; also Ampere (unit).
<b>A-h</b>	Current harmonic.
<b>Acf</b>	Crest (peak) factor of current.
<b>Ad</b>	RMS distortion current.
<b>Adc</b>	DC current.
<b>Apk+</b>	Maximum peak value of the current.
<b>Apk-</b>	Minimum peak value of the current.
<b>Arms</b>	True RMS current.
<b>Athdf</b>	Total harmonic distortion of current in % f.
<b>Athdr</b>	Total harmonic distortion of current in % r.
<b>Aunb</b>	Negative-sequence current unbalance rate.
<b>AVG</b>	Mean value (arithmetic mean).
<b>CF</b>	Peak factor (current or voltage).
<b>cos <math>\Phi</math></b>	Cosine of the phase shift of voltage with respect to current (DPF – fundamental power factor or displacement factor).
<b>DC</b>	DC component (current or voltage).
<b>DPF</b>	Displacement factor (cos F).
<b>FHL</b>	Harmonic loss factor.
<b>FK</b>	K factor.
<b>Hz</b>	Frequency of network studied.
<b>L</b>	Channel (Line).
<b>MAX</b>	Maximum value.
<b>MIN</b>	Minimum value.
<b>ms</b>	Millisecond.
<b>PEAK or PK</b>	Maximum (+) or minimum (-) peak instantaneous value of the signal.
<b>PF</b>	Power factor.
<b>PLT</b>	Long-term flicker.
<b>PST</b>	Short-term flicker.
<b>RMS</b>	True RMS value (current or voltage).

Symbol	Designation
<b>t</b>	Relative date of time cursor.
<b>tan <math>\Phi</math></b>	Tangent of the phase shift of voltage with respect to current.
<b>THD</b>	Total harmonic distortion (in %f or in %r).
<b>U</b>	Phase-to-Phase voltage.
<b>U-h</b>	Phase-to-phase voltage harmonic.
<b>Ucf</b>	Phase-to-Phase voltage crest factor.
<b>Ud</b>	Phase-to-phase RMS distortion voltage.
<b>Udc</b>	Phase-to-phase DC voltage.
<b>Upk+</b>	Maximum peak value of the phase-to-phase voltage.
<b>Upk-</b>	Minimum peak value of the phase-to-phase voltage.
<b>Urms</b>	True RMS phase-to-phase voltage.
<b>Uthdf</b>	Total phase-to-phase voltage harmonic distortion in %f.
<b>Uthdr</b>	Total phase-to-phase voltage harmonic distortion in %r.
<b>Uunb</b>	Negative-sequence phase-to-phase voltage unbalance rate.
<b>V</b>	Phase-to-neutral voltage; also Volt (unit)
<b>V-h</b>	Phase-to-neutral voltage harmonic.
<b>S</b>	Apparent power.
<b>S-h</b>	Apparent harmonic power.
<b>D</b>	Distortion power.
<b>Dh</b>	Distortion energy.
<b>Sh</b>	Apparent energy.
<b>Q<sub>1</sub></b>	Reactive power (fundamental).
<b>N</b>	Non-active power
<b>Q<sub>1h</sub></b>	Reactive energy (fundamental).
<b>Nh</b>	Non-active energy.
<b>Vcf</b>	Peak factor of the phase-to-ground voltage.
<b>Vd</b>	Phase-to-neutral RMS distortion voltage.
<b>Vdc</b>	Phase-to-neutral DC voltage.
<b>Vpk+</b>	Maximum peak value of the phase-to-neutral voltage.
<b>Vpk-</b>	Minimum peak value of the phase-to-neutral voltage.
<b>Vrms</b>	True RMS phase-to-neutral voltage.
<b>Vthdf</b>	Total harmonic distortion of phase-to-neutral voltage in %f.
<b>Vthdr</b>	Total harmonic distortion of phase-to-neutral voltage in %r.
<b>Vunb</b>	Negative-sequence phase-to-ground voltage unbalance rate.
<b>P</b>	Active power.
<b>Pdc</b>	DC power.
<b>Pdch</b>	DC energy.
<b>Ph</b>	Active energy.

## 3. USE

### 3.1. START-UP

To switch the device on, press the  button. It lights when pressed, then goes off if the mains power unit is not connected to the device.

After the software check, the home page is displayed, then the information screen that indicates the software version of the device and its serial number.



Figure 6: Home page at start-up

Then the *Waveform* screen is displayed.

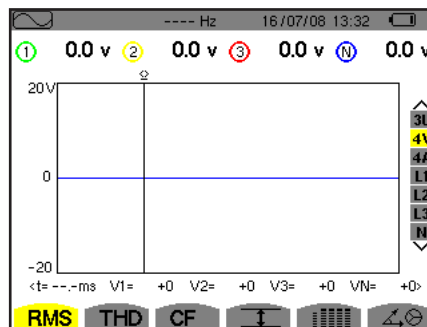





Figure 7: Waveform screen

### 3.2. CONFIGURATION

To configure the device, proceed as follows:

- Press . The configuration screen appears.
- Press  or  to select the parameter to be modified. Press  to enter the selected sub-menu.

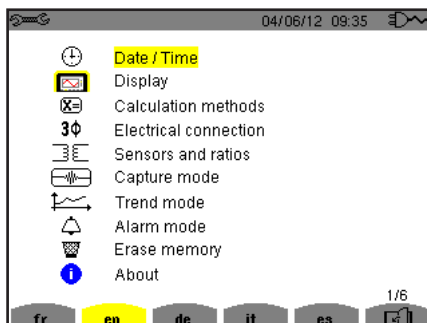







Figure 8: Configuration screen

Then use the arrow keys ( or  and  or ) and the  key to validate. For more details, see §§4.3 to 4.10.

The following points must be checked or adapted for each measurement:

- Define the parameters of the calculation methods (see §4.5).
- Select the distribution system (single-phase to five-wire three-phase) and the connection method (2 wattmeters, 2 ½ elements, standard) (see §4.6).
- Program the current ratios according to the type of current sensor connected (see §4.7).
- Program the voltage ratios (see §4.7).
- Define the triggering levels (transients mode and inrush current capture) (see §4.8).
- Define the values to be recorded (trend mode) (see §4.9).
- Define the alarm thresholds (see §4.10).

To return to the *Configuration* screen from a sub-menu, press the ↶ key.

### 3.3. INSTALLATION OF LEADS

To identify the leads and input terminals, you may mark them in accordance with the usual phase/neutral colour code using the coloured rings and inserts supplied with the device.

- Detach the insert and place it in the hole provided for it near the terminal (large insert for a current terminal; small insert for a voltage terminal).

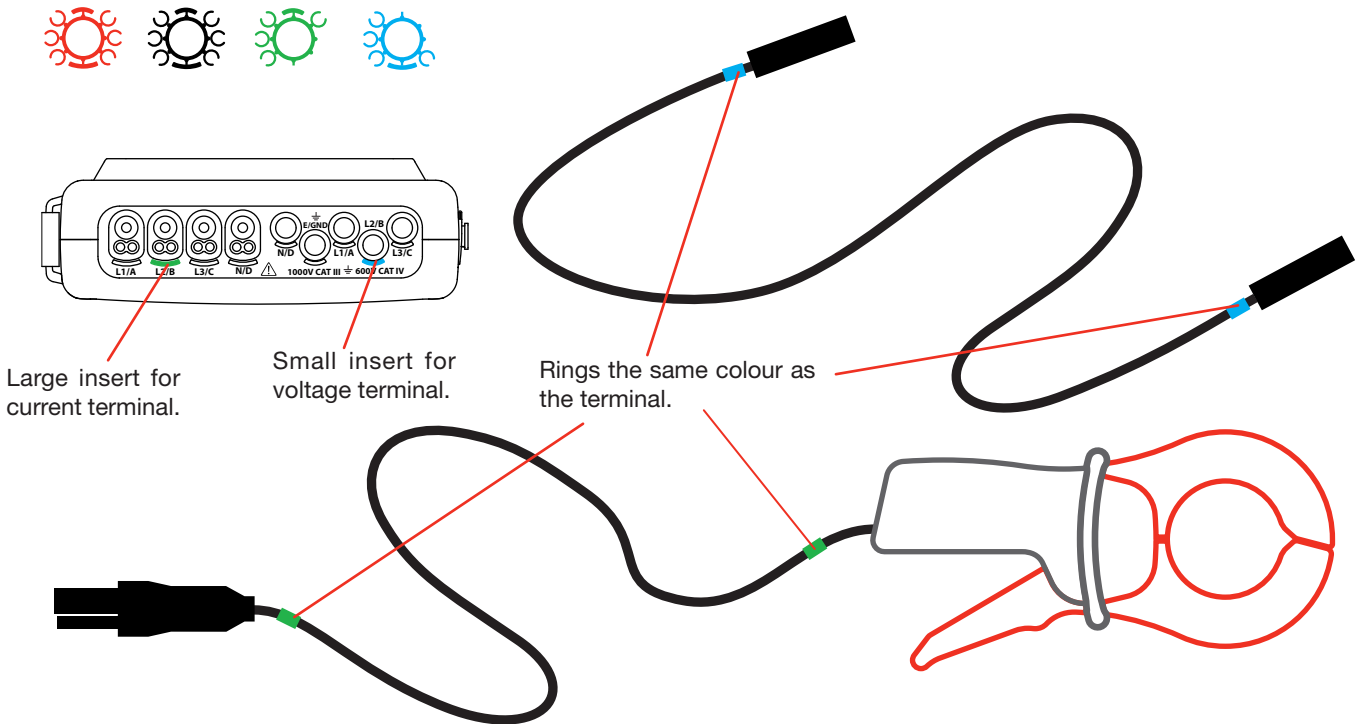

- Clip rings of the same colour to the ends of the lead you will be connecting to the terminal. Twelve sets of rings and inserts of different colours are provided to enable you to harmonize the device with any of the phase/neutral colour codes in force.
- Connect the measurement leads to the terminals of the device:

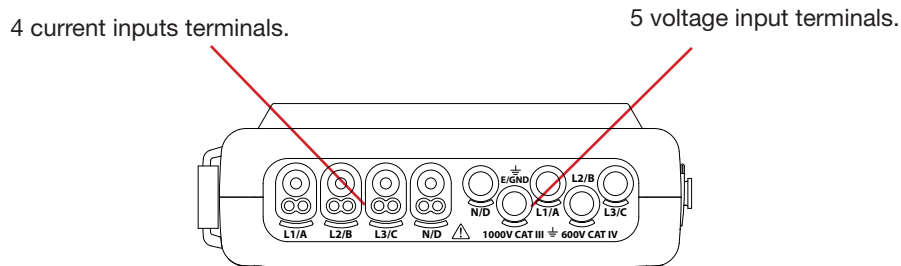

Figure 3: connection terminals

- Remember to define the transformation ratios of the current sensors and of the voltage inputs (see §4.7).



To make a measurement, you must program at least:

- the calculation method (see §4.5),
- the connection (see §4.6)
- and the ratios of the sensors (see §4.7).

The measuring leads must be connected to the circuit to be measured as shown by the following diagrams.

### 3.3.1. SINGLE-PHASE NETWORK

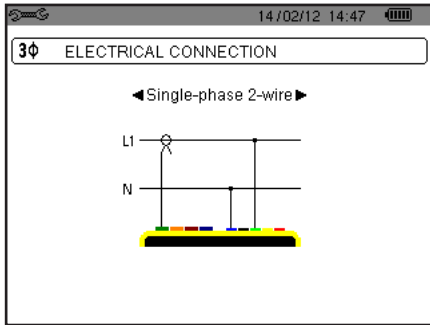

Figure 9: 2-wire single-phase connection

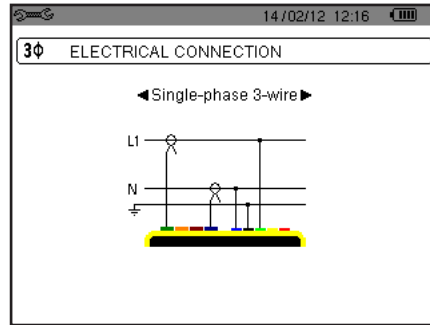

Figure 10: 2-wire single-phase connection

### 3.3.2. SPLIT-PHASE NETWORK

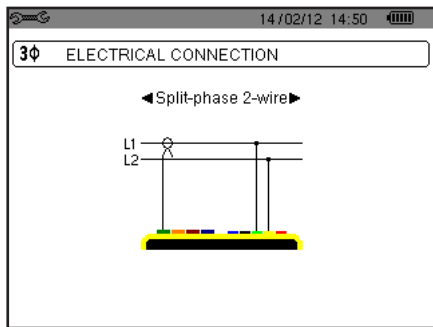

Figure 11: 2-wire split-phase connection

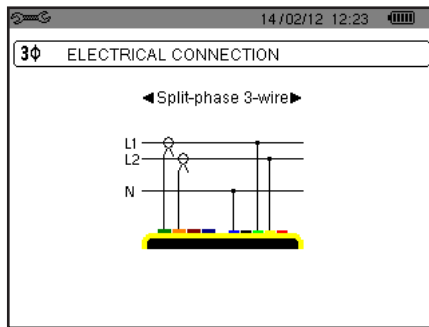

Figure 12: 3-wire split-phase connection

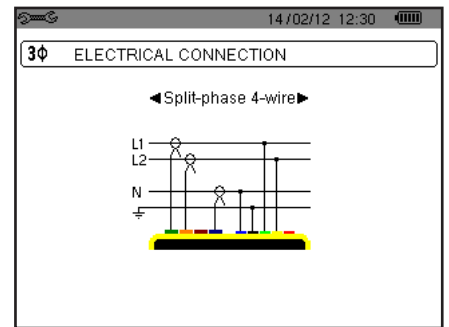

Figure 13: 4-wire split-phase connection

### 3.3.3. THREE-PHASE NETWORK

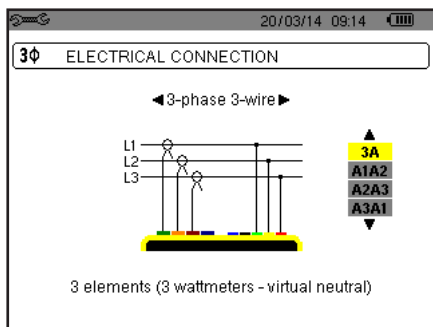

Figure 14: 3-wire three-phase connection

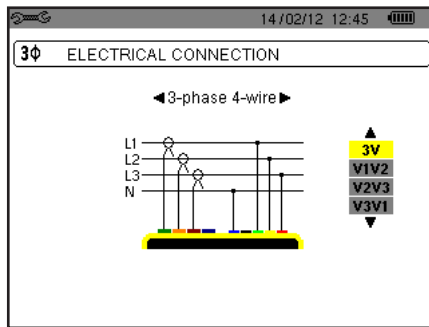

Figure 15: 4-wire three-phase connection

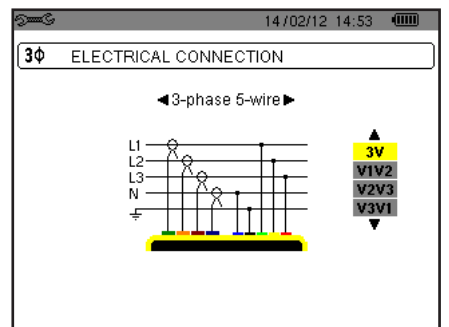

Figure 16: 5-wire three-phase connection

In the case of a three-phase network, you are not obliged to connect all of the terminals in voltage or in current.

For 3-wire three-phase, indicate the current sensors that will be connected: all 3 sensors (3A) or only 2 (A1 and A2, or A2 and A3, or A3 and A1).

For 4- and 5-wire three-phase, indicate the voltages that will be connected: all 3 voltages (3V) or only 2 (V1 and V2, or V2 and V3, or V3 and V1).

### 3.3.4. CONNECTION PROCEDURE

- Switch the instrument on.
- Configure the device for the measurement to be made and the type of network concerned (see §4),
- Connect the leads and current sensors to the unit.
- Connect the earth and/or neutral lead to the network earth and/or neutral (when it is distributed) and connect the corresponding current sensor,
- Connect the L1 phase lead to the network L1 phase and connect the corresponding current sensor.
- If applicable, repeat the procedure for phases L2 and L3 and for N.

**Note:** complying with this procedure reduces connection errors to a minimum and avoids wasting time.

Disconnection procedure:

- Proceed in the reverse of the order of connection, always finishing by disconnecting the neutral (when distributed).
- Disconnect the leads and switch the device off.

## 3.4. FUNCTIONS OF THE DEVICE

Any screen can be saved (screen snapshot) by pressing the  key for 3 seconds (see §11).

You can press the help key  at any time. The help screen will inform you about the functions and the symbols used for the current display mode.

### 3.4.1. WAVEFORM CAPTURE

With the device powered up and connected to the network, press .  
You can display the Transients mode (see §5.1) or the Inrush current mode (see §5.2).

### 3.4.2. DISPLAY OF HARMONICS

With the device powered up and connected to the network, press .  
You can display the phase-to-neutral voltage (see §6.1), the current (see §6.2), the apparent power (see §6.3) or the phase-to-phase voltage (see §6.4).

### 3.4.3. WAVEFORM MEASUREMENTS

With the device powered up and connected to the network, press .

You can display the measurements of the true RMS value (see §7.1), the measurements of the total harmonic distortion (see §7.2), the measurements of the peak factor (see §7.3), the extreme values in voltage and current (see §7.4), several values at once (see §7.5), or the Fresnel diagram (see §7.6).

### 3.4.4. ALARM RECORDING

With the device powered up and connected to the network, press .

You can configure the alarm mode (see §8.1), program an alarm campaign (see §8.2), look it up (see §8.4), or erase it (see §8.6).

### 3.4.5. RECORDING

With the device powered up and connected to the network, press .  
You can configure recordings (see §9.2) and program them (see §9.1). You can also look up or erase recordings (see §4.11).





### 3.4.6. ENERGY MEASUREMENTS

With the device powered up and connected to the network, press .  
You can measure the energies consumed (see §10.1.3) or generated (see §10.1.4, §10.2.2, or §10.3.2).

## 4. CONFIGURATION

The *Configuration* key  is used to configure the device. This must be done before each new type of measurement. The configuration remains in memory, even after the device is switched off.

### 4.1. CONFIGURATION MENU

The arrow keys (, , , ) are used to navigate in the Configuration menu and to parameterize the device. A value that can be modified is flanked by arrows.

Most of the time, confirmation () is necessary for the changes made by the user to be applied.

The return key () is used to return to the main menu from a sub-menu.

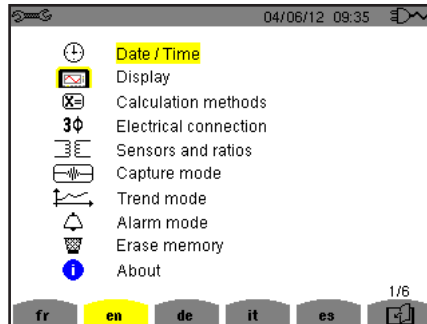

Figure 8: the Configuration screen

### 4.2. DISPLAY LANGUAGE

To select the display language, press the yellow key under the corresponding icon on the screen (Figure 6).

The active language is identified by the icon on the yellow ground.

### 4.3. DATE/TIME

The  menu defines the system date and time. The display is as follows:

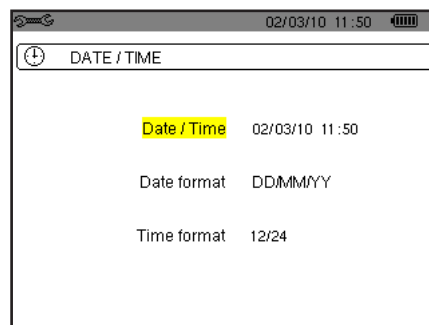







Figure 17: Date/Time menu

With the Date/Time field highlighted in yellow, press . To change a value, press  or . To move from one field to another, press  or . To confirm, press .

Proceed in the same way for the dating system (DD/MM/YY or MM/DD/YY) and the time system (12/24 or AM/PM). You see the effect immediately in the display of the date.

To return to the Configuration menu, press .

**Note:** The date and time parameters cannot be configured while the device is recording, metering energy, or searching for transients, alarms, and/or inrush current acquisition.

## 4.4. DISPLAY

### 4.4.1. BRIGHTNESS

The  menu is used to define the brightness of the display unit. The display is as follows:

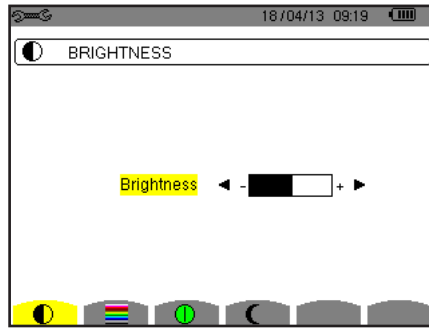



Figure 18: the Contrast/Brightness menu

Use the keys (◀, ▶) to change the brightness.  
To return to the Configuration menu, press ↻.

### 4.4.2. COLOURS

The  menu is used to define the colours of the voltage and current curves. Press the yellow key corresponding to the  icon. There are 15 colours available: green, dark green, yellow, orange, pink, red, brown, blue, turquoise blue, dark blue, very light grey, light grey, grey, dark grey, and black.

The display is as follows:

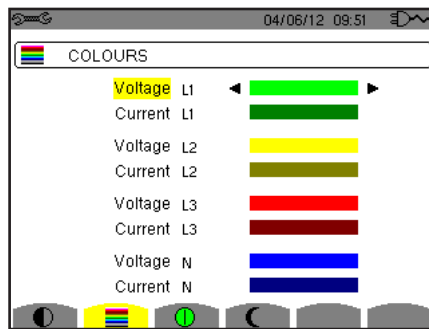

Figure 19: the Colours menu

Use the arrow keys (▲, ▼, ◀, ▶) to change the assignments of the colours.  
To return to the Configuration menu, press ↻.

### 4.4.3. MANAGEMENT OF THE SWITCHING OFF OF THE SCREEN

The  menu defines the management of the switching off of the screen. Press the yellow key corresponding to the  icon.





Figure 124: the Management of Switching off of the Screen menu

Use the arrow keys (▲, ▼) to choose the screen switching off mode: Automatic or Never.

The Automatic mode is used to save the battery. The display screen is switched off automatically after five minutes without action on the keys if the device is powered only by its battery and if recording is in progress and after ten minutes if no recording is in progress. The On/Off button  blinks to indicate that the device is still in operation. Pressing any key on the keypad relights the screen.

To return to the Configuration menu, press .

#### 4.4.4. NIGHT MODE

The  menu is used to change to night mode. Press the yellow key corresponding to the  icon.

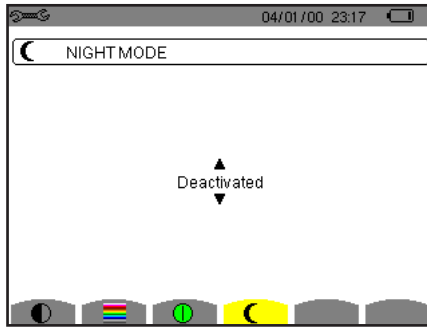





Figure 125: the night Mode menu

Use the navigation keys (, ) to activate or deactivate night mode. The screen then changes to reverse video and all colours are changed.

### 4.5. CALCULATION METHODS

The menu  defines:

- The choice of breakdown or no breakdown of the non-active quantities,
- The choice of unit of energy,
- The choice of reference for the level of harmonics of the phases,
- The choice of coefficients of calculation for the K factor,
- The choice of method of calculation of the long-term flicker.

#### 4.5.1. CHOICE OF CALCULATION OF NON-ACTIVE QUANTITIES

The **var** menu is used to choose whether or not to break down the non-active quantities (powers and energies).

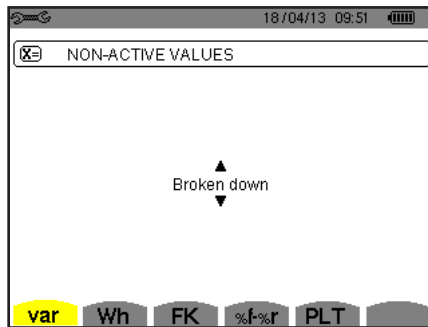



Figure 20: the Methods of Calculation of Reactive Quantities menu

Use the arrow keys (, ) to select broken down or not.

- Broken down: Non-active power N is broken down into reactive power (fundamental)  $Q_1$  and distorting power D. Non-active energy Nh is broken down into  $Q_{1,h}$  and  $D_h$ .
- Not broken down: Non-active power N and non-active energy Nh are displayed.

Then validate with the  key. The device returns to the Configuration menu.

**Note:** The modification is impossible if the device is recording, metering energy, and/or searching for alarms.

#### 4.5.2. CHOICE OF UNIT OF ENERGY

The **Wh** menu defines the unit of display of energies.

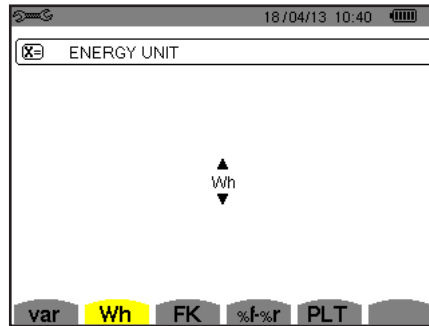

Figure 21: the Choice of Unit of Energy menu

Use the arrow keys (▲, ▼) to select the unit:

- Wh : watt-hour.
- J: joule.
- toe (nuclear): nuclear tonne oil equivalent.
- toe (non-nuclear): non-nuclear tonne oil equivalent.
- BTU: British Thermal Unit.

Then validate with the ↵ key . The device returns to the *Configuration* menu.

#### 4.5.3. CHOICE OF COEFFICIENTS OF CALCULATION OF THE K FACTOR

The **FK** menu defines the coefficients used for the calculation of the K factor.

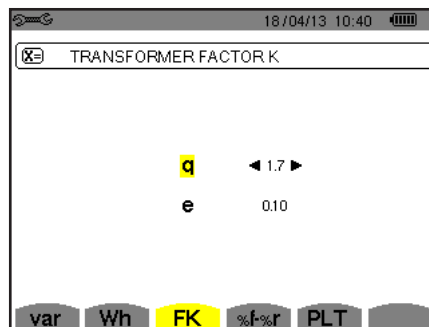

Figure 22: the Choice of coefficients of calculation of the K factor menu

Use the arrow keys (▲, ▼, ◀, ▶) to fix the value of coefficients q and e:

- q: exponential constant that depends on the type of winding and the frequency.  
The value of q can range from 1.5 to 1.7. The value of 1.7 is suitable for transformers having round or square conductors, in all types of winding. The value of 1.5 is suitable for those in which the low-voltage windings are in tape form.
- e: ratio between the losses linked to eddy currents (at the fundamental frequency) and resistive losses (both evaluated at the reference temperature). The value of e can range from 0.05 to 0.1.

The default values (q = 1.7 and e = 0.10) are suitable for most applications.

Then validate with the ↵ key. The device returns to the *Configuration* menu.

**Note:** The modification is impossible if the device is recording and/or searching for alarms.

#### 4.5.4. CHOICE OF REFERENCE OF THE LEVEL OF HARMONICS OF THE PHASES

The %f-%r menu defines the reference for the level of harmonics of the phases.

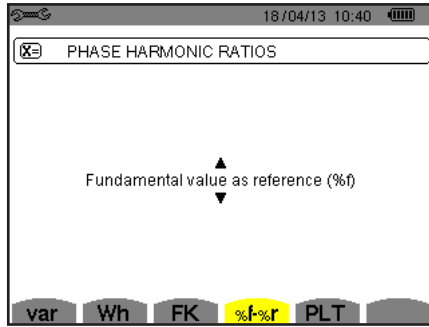

Figure 23: the Choice of Reference for the Level of Harmonics menu

Use the arrow keys (▲, ▼) to fix the reference for the level of harmonics:

- %f: the reference is the value of the fundamental.
- %r: the reference is the total value.

Then validate with the ↵ key. The device returns to the Configuration menu.

In the case of the level of harmonics of the V-h, A-h, and U-h phases, the fundamental and total values are RMS values. In the case of the level of harmonics of the S-h phases, the fundamental and total values are apparent power values.

**Note:** The modification is impossible if the device is recording and/or searching for alarms.

#### 4.5.5. CHOICE OF METHOD OF CALCULATION OF PLT

The PLT menu defines the method used to calculate the PLT (long-term flicker).

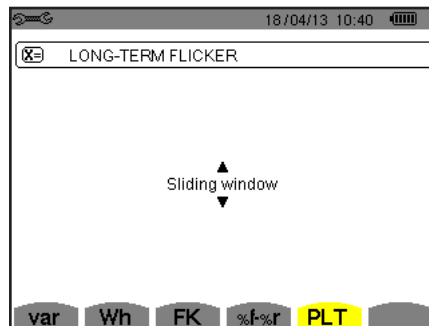

Figure 24: the Choice of Method of Calculation of PLT menu

Use the arrow keys (▲, ▼) to choose sliding or non-sliding.

- Sliding: the PLT is calculated every 10 minutes. The first value is available 2 hours after the device is switched on, because it takes 12 values of PST to calculate the PLT.
- Non-sliding: the PLT is calculated every 2 hours.

Then validate with the ↵ key . The device returns to the Configuration menu.

**Note:** The modification is impossible if the device is recording and/or searching for alarms.

## 4.6. CONNECTION

The  $3\phi$  menu is used to define how the device is connected, according to distribution system.

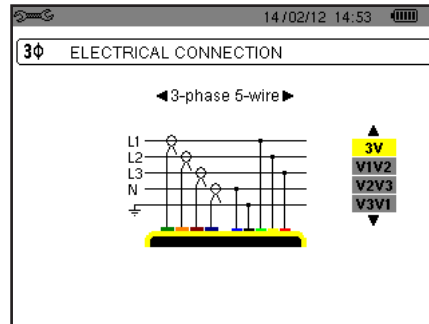
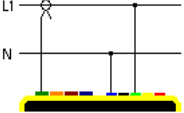
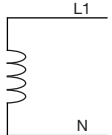
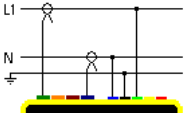
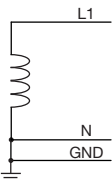
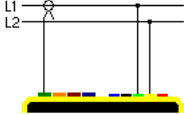
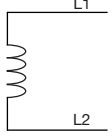



Figure 16: the Connection menu

Several electrical diagrams can be selected:  
Use the arrow keys (▲, ▼, ◀, ▶) to choose a connection.

One or more types of network correspond to each distribution system.

Distribution system	Source	
Single-phase 2-wire (L1 and N) 	Single-phase 2-wire non-earthed neutral	
Single-phase 3-wire (L1, N and earth) 	Single-phase 3-wire earthed neutral	
Split-phase 2-wire (L1 and L2) 	Split-phase 2-wire	
	3-phase open star 2-wire	

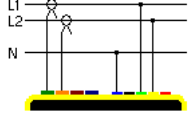
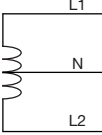
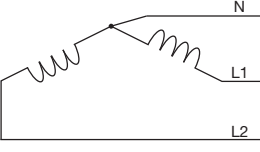
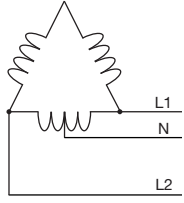
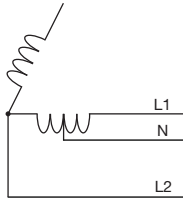
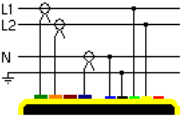
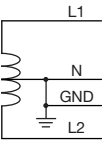
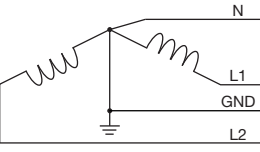
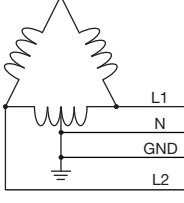
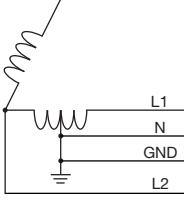

Distribution system	Source	
<p data-bbox="124 488 456 539">Split-phase 3-wire (L1, L2 and N)</p> 	Split-phase 3-wire non-earthed neutral	
	3-phase open star 3-wire non-earthed neutral	
	3-phase high leg delta 3-wire non-earthed neutral	
	3-phase open high leg delta 3-wire non-earthed neutral	
<p data-bbox="124 1308 456 1359">Split-phase 4-wire (L1, L2, N and earth)</p> 	Split-phase 4-wire earthed neutral	
	3-phase open star 4-wire earthed neutral	
	3-phase high leg delta 4-wire earthed neutral	
	3-phase open high leg delta 4-wire earthed neutral	

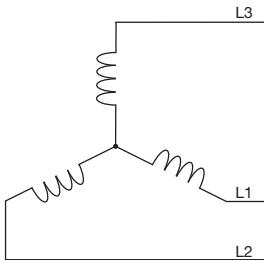
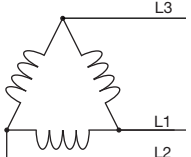
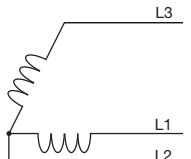
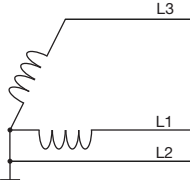
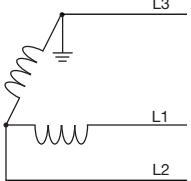
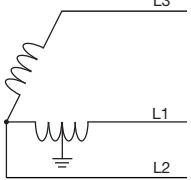
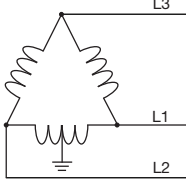
Distribution system	Source	
<p>3-phase 3-wire (L1, L2 and L3)</p>  <p>Indicate which current sensors will be connected: all 3 (3A) or only 2 (A1 and A2, or A2 and A3, or A3 and A1).</p> <p>Three-wattmeter method with virtual neutral (with 3 sensors connected) or two-wattmeter method or two-element method or Aron method (with 2 sensors connected).</p> <p>A third sensor is not necessary if two sensors of the same type, same range, and same ratio are connected. Otherwise, the third sensor must be connected to make current measurements.</p>	3-phase star 3-wire	
	3-phase delta 3-wire	
	3-phase open delta 3-wire	
	3-phase open delta 3-wire earthed junction of phases	
	3-phase open delta 3-wire earthed corner of phase	
	3-phase high leg delta 3-wire	
	3-phase open high leg delta 3-wire	

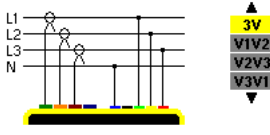
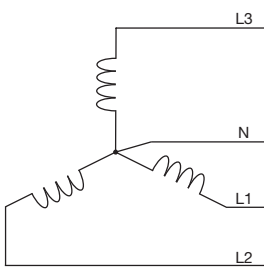
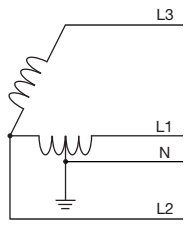
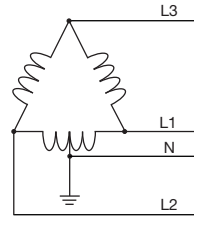
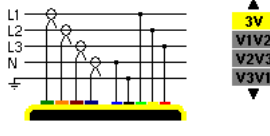
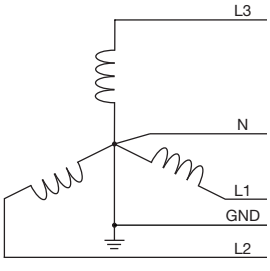
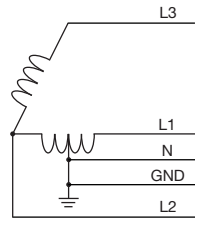
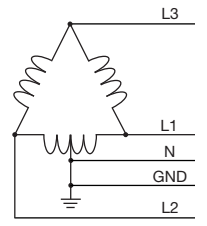
Distribution system	Source	
<p>3-phase 4-wire (L1, L2, L3 and N)</p>  <p>Indicate which voltages will be connected: all 3 (3V) or only 2 (V1 and V2, or V2 and V3, or V3 and V1).</p> <p>If only two of the three voltages are connected, the three phase voltages must be balanced (2½-element method)</p>	<p>3-phase star 4-wire non-earthed neutral</p>	
	<p>3-phase open high leg delta 4-wire non-earthed neutral</p>	
	<p>3-phase high leg delta 4-wire non-earthed neutral</p>	
<p>3-phase 5-wire (L1, L2, L3, N and earth)</p>  <p>Indicate which voltages will be connected: all 3 (3V) or only 2 (V1 and V2, or V2 and V3, or V3 and V1).</p> <p>If only two of the three voltages are connected, the three phase voltages must be balanced (2½-element method)</p>	<p>3-phase star 5-wire earthed neutral</p>	
	<p>3-phase open high leg delta 5-wire earthed neutral</p>	
	<p>3-phase high leg delta 5-wire earthed neutral</p>	

Then validate with the ↵ key . The device returns to the *Configuration* menu.

This makes it possible to connect the device to all existing networks.

**Note:** It is impossible to select a new connection if the device is recording, metering energy, or searching for transients, alarms, and/or inrush current acquisitions.

## 4.7. SENSORS AND RATIOS

**Note:** The ratios cannot be changed if the device is recording, metering energy, or searching for transients, alarms, and/or inrush current acquisitions.

### 4.7.1. CURRENT SENSORS AND RATIOS

A first screen **A** is used to define the current sensors and ratios. It automatically displays the current sensor models detected by the device. If a sensor is detected but not managed, an error message is displayed.

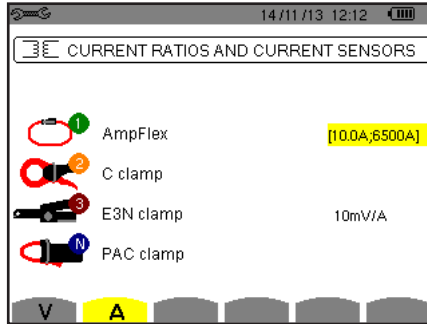









Figure 25: Current clamp and ratios screen in the Sensors and ratios menu

In the case of a 3-wire three-phase set-up where only two of the three current sensors required are connected, if these two sensors are of the same type and have the same ratio, the device simulates the third sensor by assuming the same characteristics as for the two others. The third sensor will be shown in the list as being simulated, or impossible to simulate otherwise.

The various current sensors are:

	MN93 clamp: 200 A.
	MN93A clamp: 100 A or 5 A.
	C193 clamp: 1000 A.
	J93 clamp : 3500 A.
	AmpFLEX™ A193: 100, 6500 or 10000 A.
	MiniFLEX MA193: 100, 6500 or 10000 6500 A.
	PAC93 clamp: 1000 A.
	E3N clamp: 100 A (sensitivity 10 mV/A).
	E3N clamp: 10 A (sensitivity 100 mV/A).
	Three phase adapter: 5 A.

If an *MN93A clamp* (5A range) or an *Adapter* is used, the current ratio setting is proposed automatically.

If an *MN93A clamp* (5A range), an *Adapter*, an *AmpFLEX™*, a *MiniFLEX*, or an *E3N clamp* is used, adjustment of the ratio, of the range, or of the sensitivity is proposed automatically.

Use the arrow keys (▲, ▼, ◀, ▶) to define the transformation ratios between the primary current (1A to 60,000A) and the secondary current (1A, 2A or 5A), then validate with the ↵ key.

The primary current cannot be less than the secondary current.

### 4.7.2. VOLTAGE RATIOS

A second screen **V** or **U**, defines the voltage ratios.

The programming of the ratio or ratios can be different or the same for all or for some channels.

The ratios to be programmed are phase-to-neutral voltage ratios when there is a neutral and phase-to-phase voltage ratios when there is not.

To change the ratios, press the ↵ key.

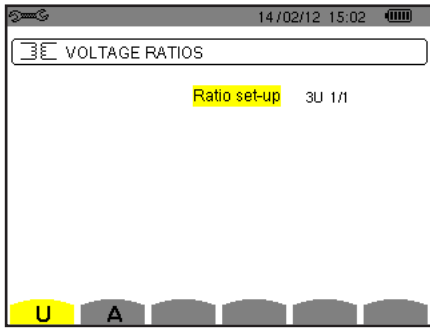

Figure 26: the Voltage Ratios screen in the Sensors and ratios menu in the case of a set-up **without** neutral

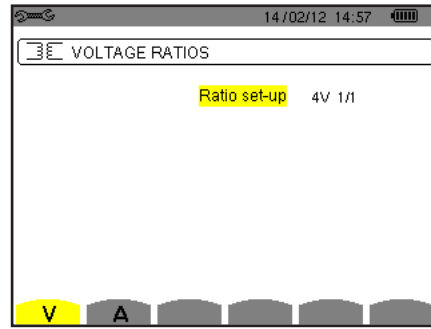

Figure 27: the Voltage Ratios screen in the Sensors and ratios menu in the case of a set-up **with** neutral

Use the arrow keys (▲, ▼) to choose the configuration of the ratios.

- 3U 1/1 or 4V 1/1: all channels have the same 1/1 ratio.
- 3U or 4V: all channels have the same ratio, to be programmed.
  - Press the ↵ key, then use the ▲, ▼ keys to highlight the ratio in yellow.
  - Press the ↵ key, then use the ▲, ▼, ◀ and ▶ keys to change the ratio. The primary voltage is in kV and the secondary voltage is in V.
- 3V + VN: all channels have the same ratio and the neutral has a different ratio. Proceed as when there is only one ratio, but perform the operation twice.
- U1+U2+U3 or V1+V2+V3+VN: each channel has a different ratio, to be programmed. Proceed as when there is only one ratio, but perform the operation several times.

Validate with the ↵ key. To return to the Configuration menu, press ↶.

**Note:** the primary and secondary voltages can each be configured with a multiplier factor of  $1/\sqrt{3}$ .

## 4.8. CAPTURE MODE

The  mode is used to configure the voltage thresholds, the current thresholds of the transient mode, and the current thresholds of the inrush current mode.

### 4.8.1. VOLTAGE THRESHOLDS OF THE TRANSIENT MODE

A  first screen, displayed by pressing the **V** icon (or **U**, for set-ups without a neutral), is used to configure the voltage thresholds.

The thresholds programmed can be the same for all channels or different for some or all of them.

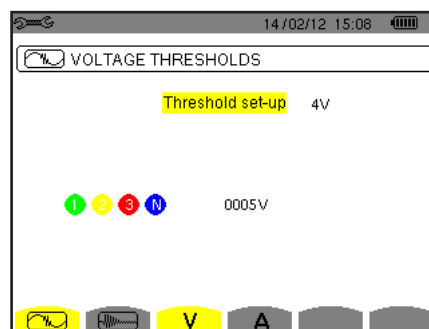



Figure 28: the Current thresholds screen in the Transient Mode menu

To change the voltage thresholds, press ↵.

Use the arrow keys (▲, ▼) to choose configuration of the thresholds.

- 4V or 3U: all channels have the same threshold.
  - Press the ↵ key, then use the ▲, ▼ keys to highlight the value of the threshold in yellow.
 
  - Press the ↵ key, then use the ▲, ▼, ◀ and ▶ keys to change the threshold. The unit can be the V or the kV.
 
- 3V + VN: all channels have the same ratio and the neutral has a different ratio. Proceed as when there is only one ratio, but perform the operation twice.
- V1+V2+V3+VN or U1+U2+U3: each channel has a different ratio, to be programmed. Proceed as when there is only one ratio, but perform the operation several times.

Validate with the ↵ key. To return to the Configuration menu, press ↶.

**Note:** Changing the thresholds in the transient mode is impossible if the device is searching for transients.

#### 4.8.2. CURRENT THRESHOLDS OF THE TRANSIENT MODE

A second  screen, displayed by pressing the **A** icon, is used to configure the current thresholds (independently of the current sensors detected by the device).

The thresholds programmed can be the same for all channels or different for some or all of them.

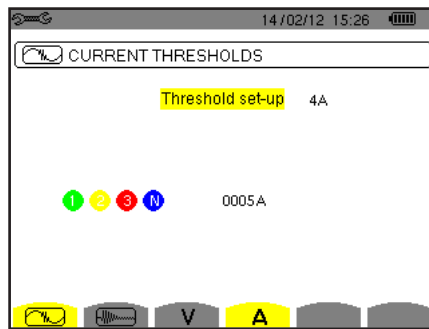



Figure 29: the Voltage thresholds screen in the Transient Mode menu

To change the current thresholds, press ↵.

Use the arrow keys (▲, ▼) to choose configuration of the thresholds.

- 4A: all current sensors have the same threshold.
  - Press the ↵ key, then use the ▲, ▼ keys to highlight the value of the threshold in yellow.
 
  - Press the ↵ key, then use the ▲, ▼, ◀ and ▶ keys to change the threshold. The unit can be the A, the kA or the mA.
 
- 3A + AN: all current sensors have the same threshold and the one connected to the neutral has a different threshold. Proceed as when there is only one ratio, but perform the operation twice.
- A1+A2+A3+AN: each current sensor has a different threshold, to be programmed. Proceed as when there is only one ratio, but perform the operation several times.

Validate with the ↵ key. To return to the Configuration menu, press ↶.

**Note:** Changing the thresholds in the transient mode is impossible if the device is searching for transients.

### 4.8.3. CURRENT THRESHOLDS OF THE INRUSH CURRENT MODE

A third screen, displayed by pressing the  icon, is used to define the inrush current thresholds. This involves programming the triggering threshold and the inrush current capture stopping threshold (the stopping threshold being the triggering threshold less the hysteresis).

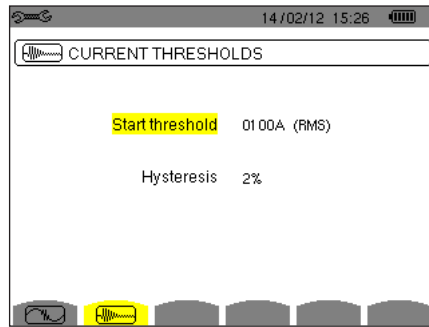

Figure 30: the Inrush Current Thresholds screen in the Inrush Current Mode menu

To change the inrush current triggering threshold, press the  $\leftarrow$  key. Use the  $\uparrow$ ,  $\downarrow$ ,  $\leftarrow$  and  $\rightarrow$  keys to change the triggering threshold. The unit can be the A, the kA, or the mA. Press the  $\leftarrow$  key, then use the  $\uparrow$ ,  $\downarrow$  keys to highlight the hysteresis in yellow. Use the  $\uparrow$ ,  $\downarrow$ ,  $\leftarrow$  and  $\rightarrow$  keys to change the hysteresis and press the  $\leftarrow$  key to validate.



**Notes:** for more information on the hysteresis, refer to §16.3. Configuring the hysteresis at 100% is equivalent to not having a stop threshold (see §16.7).

Changing the thresholds in inrush current mode is impossible if the device is in inrush current capture.

To return to the *Configuration* menu, press .

### 4.9. TREND MODE

The device has a recording function ( key, see §9), used to record measured and calculated values (Urms, Vrms, Arms, etc.).

Press the key of the  *Configuration* mode and select the  *Trend Mode* sub-menu.

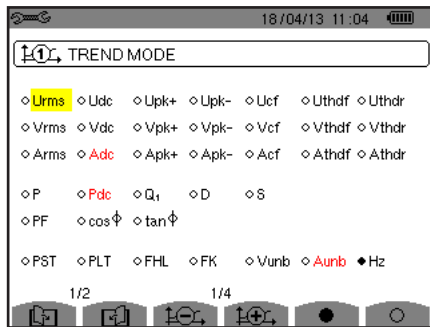

Figure 31: The first screen of the Trend mode

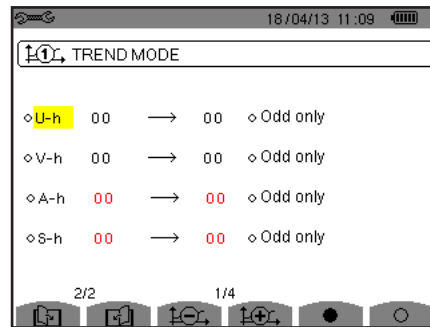







Figure 32: The second screen of the Trend mode

There are 4 possible programmable configurations , , , and , independent of one another. To go from one to the other, use the  or  key.

To select the parameter to be recorded, move the yellow cursor to this parameter using the  $\uparrow$ ,  $\downarrow$ ,  $\leftarrow$  and  $\rightarrow$  keys then validate with the  $\leftarrow$  key. The selected parameter is identified by a red spot. The frequency (Hz) is always selected (black spot).

**Note:** If a quantity is displayed in red, it means that it is incompatible with the configuration chosen (connection selected, sensors connected, ratios programmed, reference of the level of harmonics of the phases, breakdown of the non-active quantities). For example, if no current sensor is connected, all current quantities will be in red.

To select all of the parameters of a page, press the  key.

To unselect all of the parameters of a page, press the  key.

To change configuration pages, press the  or  key.

The recordable values are:

Unit	Designation
Urms	RMS phase-to-phase voltage.
Udc	RMS phase-to-neutral voltage.
Upk+	Maximum peak value of phase-to-phase voltage.
Upk-	Minimum peak value of phase-to-phase voltage.
Ucf	Crest (peak) factor of phase-to-phase voltage.
Uthdf	Harmonic distortion of the phase-to-phase voltage with the RMS value of the fundamental as reference.
Uthdr	Harmonic distortion of the phase-to-phase voltage with the total RMS value without DC as reference.
Vrms	RMS phase-to-neutral voltage.
Vdc	DC phase-to-neutral voltage.
Vpk+	Maximum peak value of the phase-to-neutral voltage.
Vpk-	Minimum peak value of the phase-to-neutral voltage.
Vcf	Crest factor of phase-to-neutral voltage.
Vthdf	Harmonic distortion of the phase-to-neutral voltage with the RMS value of the fundamental as reference.
Vthdr	Harmonic distortion of the phase-to-neutral voltage with the total RMS value without DC as reference.
Arms	RMS current.
Adc	DC current.
Apk+	Maximum peak value of the current.
Apk-	Minimum peak value of the current.
Acf	Crest factor of current.
Athdf	Harmonic distortion of the current with the RMS value of the fundamental as reference.
Athdr	Harmonic distortion of the current with the total RMS value without DC as reference.
P	Active power.
Pdc	DC power.
$Q_1$	Reactive power (fundamental).
N	Non-active power.
D	Distortion power.
S	Apparent power.
PF	Power factor.
$\cos \Phi$	Cosine of the phase shift of the voltage with respect to the current (displacement factor or fundamental power factor – DPF).
$\tan \Phi$	Tangent of the phase shift of the voltage with respect to the current.
PST	Short-term flicker.
PLT	Long-term flicker.
FHL	Harmonic loss factor
FK	K factor.
Vunb or Uunb	Negative-sequence phase-to-ground voltage unbalance factor (set-up with neutral). Negative-sequence phase-to-phase voltage unbalance factor (set-up without neutral).
Aunb	Negative-sequence current unbalance factor.
Hz	Network frequency.
U-h	Harmonics in phase-to-phase voltage.
V-h	Harmonics in phase-to-neutral voltage
A-h	Harmonics in current.
S-h	Harmonics in power.



The four last lines involve the recording of the harmonics of U, V, A and S. You can select a range of orders of the harmonics to be recorded (between 0 and 50) for each of these quantities, and within this range, if desired, only odd harmonics.

**Note:** The level of harmonics of order 01 will be displayed only if they concern values expressed in % r.

To change an order of harmonic, first select the parameter to be recorded (identified by a red spot), then move the yellow cursor to this figure using the ▲, ▼, ◀ and ▶ keys, then validate with the ↵ key. Change the value using the ▲ and ▼ keys, then validate with the ↵ key.

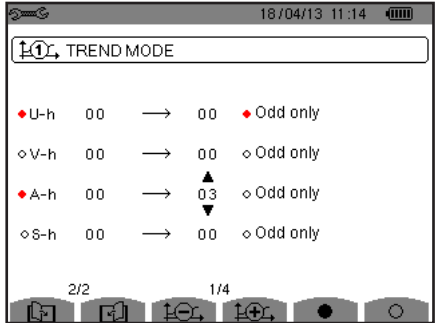

Figure 33: The second screen of the Trend Mode during modification

**Note:** If a recording is in progress, the associated configuration cannot be modified and the selected values are identified by black spots.

To return to the Configuration menu, press ↶.

### 4.10. MODE ALARM MODE

The 🚨 screen defines the alarms used by the Alarm Mode function (see §7).

You can define an alarm on each of the following parameters: Hz, Urms, Vrms, Arms, IUdcl, IVdcl, IAdcl, IUpk+l, IVpk+l, IApk+l, IUpk-l, IVpk-l, IApk-l, Ucf, Vcf, Acf, Uthdf, Vthdf, Athdf, Uthdr, Vthdr, Athdr, IPI, IPdcl, IQ<sub>1</sub> or N, D, S, IPFI, Icos Φl, Itan Φl, PST, PLT, FHL, FK, Vunb (or Uunb for a three-phase source without neutral), Aunb, U-h, V-h, A-h and IS-hl (see the table of abbreviations in §2.9).

There are 40 programmable alarms.

To activate an alarm, move the yellow cursor to its number using the ▲, ▼ keys, then validate with the ↵ key. The active alarm is identified by a red spot. An alarm that is not programmed (“?”) cannot be activated.

To program the alarm, move the yellow cursor using the ▲, ▼, ◀ and ▶ keys, then validate with the ↵ key. Change the value, then validate again.

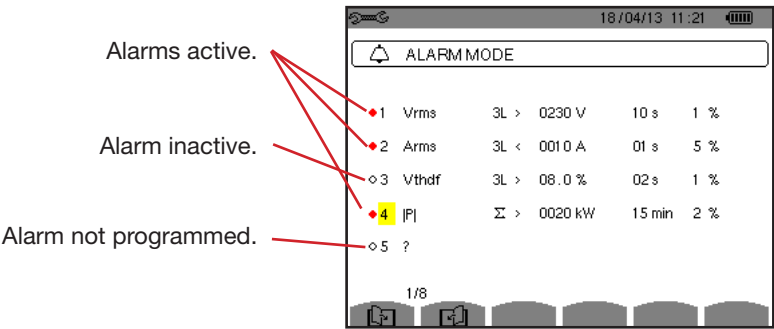



Figure 34: The Alarm mode menu

To set an alarm, program the following values:

- The type of alarm.
- The order of the harmonic (between 0 and 50), for IS-hl, A-h, U-h and V-h only.
- The target of the alarm:
  - 3L: 3 phases monitored individually,
  - N: monitoring of neutral,
  - 4L: 3 phases and neutral monitored individually,
  - $\Sigma$ : surveillance of the value of the complete system.
- The direction of the alarm (>or <) in the case of Hz, Urms, Vrms, Arms, IUdcl, IVdcl, IAdcl, IUpk+l, IVpk+l, IApk+l, IUpk-l, IVpk-l and IApk-l.
- The triggering threshold of the alarm (value and unit for Urms, Vrms, Arms, IUdcl, IVdcl, IAdcl, IUpk+l, IVpk+l, IApk+l, IUpk-l, IVpk-l, IApk-l, IPI, IPdcl, IQ<sub>r</sub>l or N, D and S).
- The triggering delay, or minimum duration above or below the alarm threshold: in minutes or seconds or, in the case of Vrms, Urms and Arms (excluding the neutral), in hundredths of a second.
- The hysteresis: 1%, 2%, 5% or 10% (see §16.3).

To go from one page to the other, press the  or  key.

Each overshoot of an alarm will be recorded in a campaign of alarms.

**Notes:** The display in red of an alarm line means that the programmed quantity and/or target is incompatible with the configuration chosen (connection selected, sensors connected, ratios programmed, calculation methods chosen).

The alarms on the level of harmonics of order 01 concern only the values expressed in % r.

If a search for alarms is in progress, the activated alarms cannot be modified and are identified by black spots. However, new alarms (not yet programmed or not activated) can be activated.

To return to the Configuration menu, press .

## 4.11. ERASE MEMORY

The  menu partially or totally deletes the data recorded in the device.

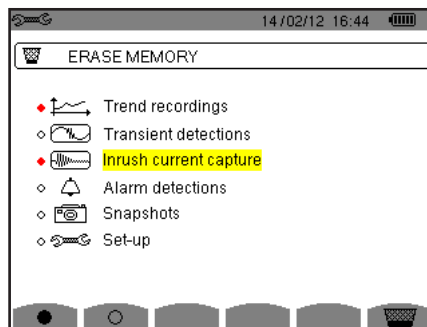

Figure 35: Erase memory menu

To select an item to be erased, move the yellow cursor to it using the ▲, ▼, ◀ and ▶ keys, then validate with the ↵ key. The item to be erased is identified by a red spot.

To select all items, press ●.

To unselect all items, press ○.

To proceed with the erasure, press the  key, then confirm with the ↵ key.

To return to the Configuration menu, press .

**Note:** Which erasures are possible depends on the recordings in progress (recording, metering of energy, search for transients, alarms, and/or inrush current acquisition).

## 4.12. ABOUT

The **i** About screen displays information concerning the device.

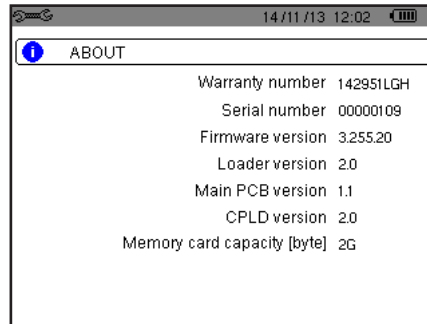

*Figure 36: the About menu*

To return to the Configuration menu, press .

# 5. WAVEFORM CAPTURE

The  *Waveform capture* mode is used to display and to capture transients and inrush currents.

It contains two sub-modes:

- The transient mode (see §5.1)
- The inrush current mode (see §5.2)

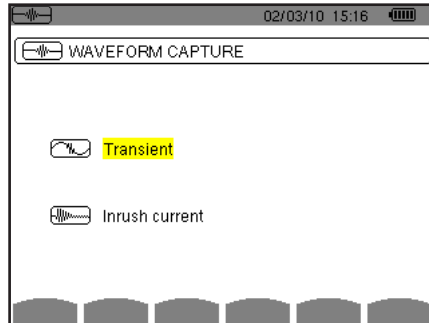



Figure 37: the screen of the Waveform capture mode

To select a sub-mode, move the yellow cursor to it using the ▲ and ▼ keys, then validate with the ↵ key.

To return to the *Waveform capture* screen, press ↶.

## 5.1. TRANSIENT MODE

The  mode is used to record transients, to look up the list of recorded searches and the list of transients they contain, or erase them. You can record up to 7 detections and 210 transients.

When the Transient mode is invoked:

- If no recording has been made, then the *Detection schedule* screen is displayed.
- If transients have been recorded, then the *List of searches for transients* is displayed.

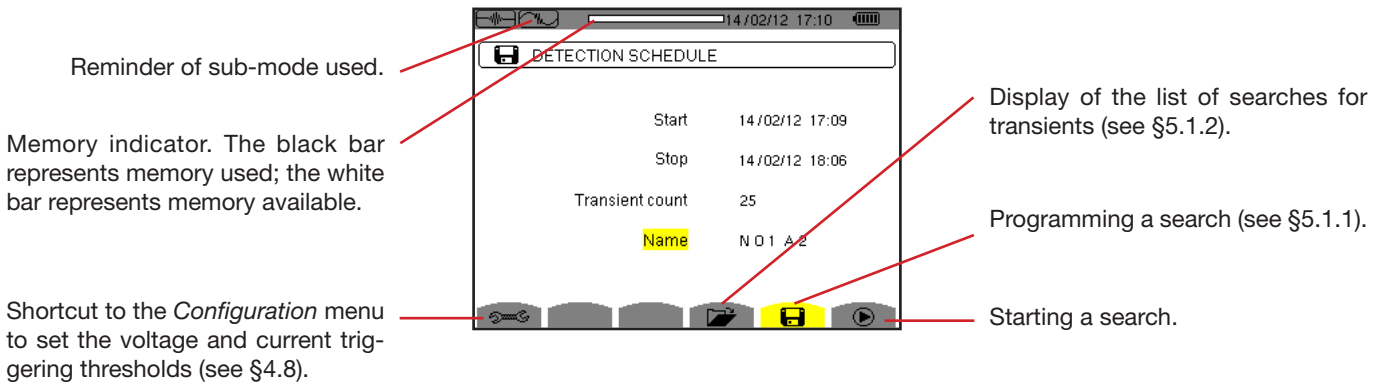

Figure 38: the Detection schedule screen in Transient mode

### 5.1.1. PROGRAMMING AND STARTING A SEARCH

To program a search for a transient, enter the start date and time, the stop date and time, the number of transients to search for, then the name of the search.

To change an item, move the yellow cursor to it using the ▲ and ▼ keys, then validate with the ↵ key. Change the value using the ▲, ▼, ◀ and ▶ keys, then validate again.

The name can be at most 8 characters long. Several searches can bear the same name. The available alphanumeric characters are the uppercase letters from A to Z and the digits from 0 to 9. The last 5 names given (in the transient, trend, and alarm modes) are kept in memory. When a name is entered, it may then be completed automatically.

**Notes:** The start date and time must be later than the current date and time.

The stop date and time must be later than the start date and time.

Once the programming is done, start the search by pressing the ▶ key. The ▶ icon of the status bar blinks to indicate that the search has been started. The ⏸ key replaces the ▶ key and can be used to stop the search before it is finished.

The message *Detection on standby* is displayed until the start time is reached. It is then replaced by the message *Detection in progress*. When the stop time is reached, the *Detection schedule* screen returns with the ▶ key. It is then possible to program another search.

During a search for transients, only the stop date field can be modified. It is automatically highlighted in yellow.

To return to the *Waveform capture* screen, press ↶.

### 5.1.2. DISPLAYING A TRANSIENT

To display the recorded transients, press 📄. The *List of Searches for Transients* screen is displayed.

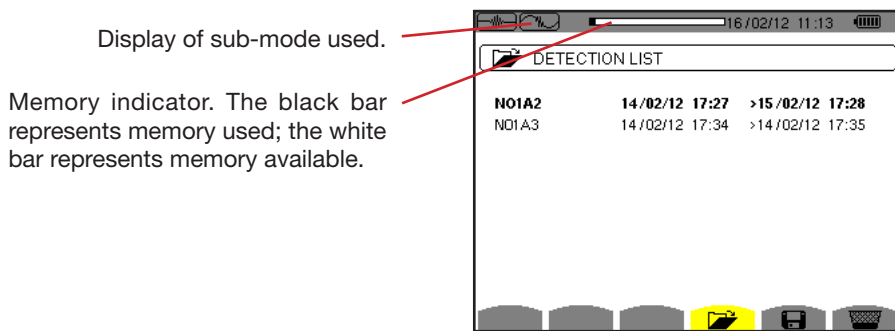

Figure 39: the screen of the *List of Searches for Transients*

If the stop date is in red, it means that it does not match the stop date initially programmed:

- either because of a power supply problem (battery low or disconnection of the device supplied by mains only),
- or because the number of transients has been reached, thereby ending the search.

To select a search for transients, move the cursor to it using the ▲ and ▼ keys. The selected search is bolded. Then validate with the ↵ key. The device then displays a list of transients.

Triggering channel of the transient.  
 Transient number.  
 Name of the search for transients.  
 The ▼ icon is used to activate or deactivate the choice of a transient list display filter.

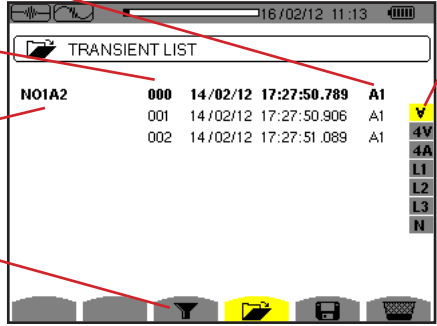

Transients display filter:  
 ▼: all transients are displayed.  
 4 V: the transients triggered by an event in one of the 4 voltage channels are displayed.  
 4 A: the transients triggered by an event in one of the 4 current channels are displayed.  
 L1, L2, or L3: the transients triggered by an event on a particular phase are displayed (voltage or current).  
 N: the transients triggered by an event on the neutral current or neutral voltage are displayed.

Figure 40: The Transient list screen in the case of a 5-wire three-phase set-up

To select a transient, move the cursor to it using the ▲ and ▼ keys. The selected field is bolded. Then validate with the ↵ key. The device displays the transients in the form of curves.

Location in the record of the zone displayed.  
 Move the cursor to one period of the signal before the transient triggering time.  
 Move the cursor to the transient triggering time.

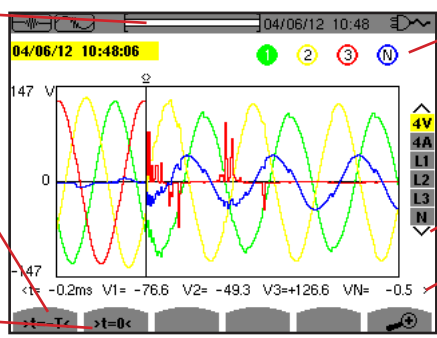

Reminder of the number assigned to the curve displayed; here, identification disc 1 is filled in to indicate that channel V1 triggered capture of the transient.  
 Selection of curves to be displayed.  
 Instantaneous value of the signals according to the position of the cursor on the scale. To move the cursor use the ◀ or ▶ key.

Figure 41: example of display of transients in the form of curves with a 5-wire three-phase connection

**Note:** The curves to be displayed selection filter is dynamic and depends on the connection chosen. For example, it proposes (3U, 3A) for a 3-wire three-phase set-up

To return to the *Transient list* screen, press ↶.

**5.1.3. DELETING A SEARCH FOR TRANSIENTS**

When the list of searches for transients is displayed (see figure 39), select the search to be erased. This is done by moving the cursor to it using the ▲ and ▼ keys. The selected search is bolded.

Then press the key. Press ↵ to validate or ↶ to cancel.

**Note:** A search for transients can be deleted only if it is not in progress.

To return to the Waveform capture screen, press the ↶ key.



**5.1.4. DELETE A TRANSIENT**

When the list of transients in a search is displayed (see figure 40), select the transient to be erased. This is done by moving the cursor to it using the ▲ and ▼ keys. The selected transient is bolded.

Then press the key. Press ↵ to validate or ↶ to cancel.

To return to the Waveform capture screen, press the ↶ key .

## 5.2. INRUSH CURRENT MODE

Still in the  mode, the  sub-mode is used to capture (record) inrush currents (voltage and current waveforms, network frequency, half-cycle RMS voltages and currents except for the neutral) and to view and delete the recordings.

When the Inrush current mode is invoked:

- If no capture has been made, then the *Capture schedule* screen is displayed.
- If a capture has been made, then the *Capture characteristics* screen is displayed.

### 5.2.1. PROGRAMMING THE CAPTURE

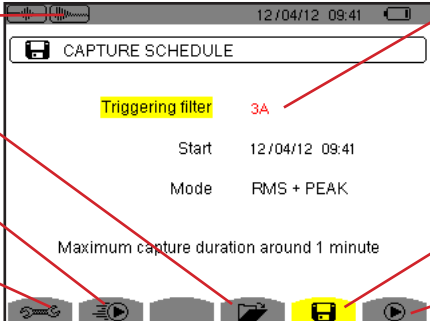

Display of sub-mode used.

Display of the characteristics of the capture (see §5.2.2).

Rapid programming and starting of a capture.

Shortcut to the *Configuration* menu to set the triggering thresholds (see §4.8).

The display of the triggering filter in red means that it is not available because of an incompatibility with the configuration (connection, type of sensors, or current ratio). Programming of the capture.

Start of the capture.

Figure 42: the Capture schedule

screen in Inrush current mode

To start recording rapidly, press the  key. Recording starts immediately with a current threshold of 0 A and a hysteresis of 100%.

**Attention:** The rapid starting of an inrush current modifies the configuration of the current threshold.





To program a capture, enter the triggering filter (3A, A1, A2, or A3), the start date and time, and the recording mode (**RMS + PEAK** or **RMS only**).

- The **RMS + PEAK** recording mode is used to produce a trend recording of the half-period RMS values and a trend recording of the samples (envelopes and waveforms). The maximum duration of such a recording depends on the frequency network and is on average about one minute.
- In the **RMS only** recording mode, the recording of the samples is eliminated in favour of a longer maximum capture duration. This mode records only the half-period RMS values and its maximum duration is about ten minutes.

To modify an item, move the yellow cursor to it using the **▲** and **▼** keys, then validate with the **↵** key. Change the value using the **▲**, **▼**, **◀** and **▶** keys, then validate again.

**Notes:** For more information on the triggering filter, refer to §16.7.

It is not possible to program an alarm campaign if an inrush current capture is in progress.

Once the programming is done, start the capture by pressing the  key. The  icon of the status bar blinks to indicate that the capture has been started. The  key replaces the  key and can be used to stop the capture before it is finished.

**Attention:** The voltage must be present before the inrush current strictly speaking for a stable and correct frequency lock.

The message *capture pending* is displayed until the start time is reached and the triggering conditions are satisfied. It is then replaced by the message *Capture in progress*. The memory occupation indicator appears at the top of the screen. The indicator disappears when the capture is completed.



If the capture is completed with a stop event (see conditions in §16.7) or if the recording memory of the device is full, the capture stops automatically.

**Note:** The device can keep in memory only a single inrush current capture. If you wish to make another capture, first delete the previous one.

To return to the Waveform capture screen, press .

### 5.2.2. DISPLAYING THE CHARACTERISTICS OF THE CAPTURE

To display the characteristics of the capture, press . The *Capture parameters* screen is displayed.

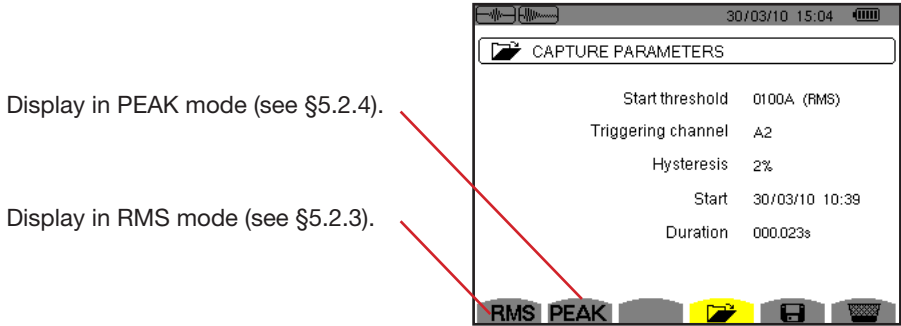

Figure 43: The Capture parameters screen

If a capture duration is displayed in red, it means that it has been cut short:

- because of a power supply problem (battery low),
- or because the memory is full.
- or because of a measurement error.
- or because of an incompatibility between the quantity monitored and the configuration of the device (for example withdrawal of a current sensor).

Choose the type of display, **RMS** or **PEAK**, by pressing the yellow key corresponding to the icon. The device then displays the curves.

**Note:** the PEAK key is not displayed when the inrush current capture recording mode is RMS only.

### 5.2.3. TRUE RMS CURRENT AND VOLTAGE

The RMS mode displays the record of the trend of the true half-cycle RMS current and voltage and the frequency trend curve.

The display depends on the type of selection filter:

- 3V:** displays the 3 voltages during the inrush current capture for set-ups with neutral.
- 3U:** displays the 3 voltages during the inrush current capture for set-ups without neutral.
- 3A:** displays the 3 currents during the inrush current capture.
- L1, L2, L3:** display the current and voltage in phases 1, 2 and 3 respectively (for set-ups with neutral only).
- Hz:** displays the evolution of the network frequency vs. time.

Below, three examples of display.

#### 5.2.3.1. The 3A RMS display screen for a three-phase connection with neutral

Location of the zone displayed in the record.

Scale of values in amperes.

Time cursor. Use the ◀ or ▶ key to move the cursor.

t: relative time position of the cursor (t=0 corresponds to the start of the inrush current capture).



**MAX:** maximum half-cycle RMS value of the inrush current capture. Reminder of number assigned to the curve displayed. Here, identification disc 1 is filled in, indicating that channel A1 triggered the inrush current capture.

**A1, A2, A3:** RMS values of currents 1, 2, and 3 in the half-cycle at the position of the cursor.

Figure 44: The 3A RMS display screen for a three-phase connection with neutral



5.2.3.2. The 3A RMS display screen for a three-phase connection without neutral

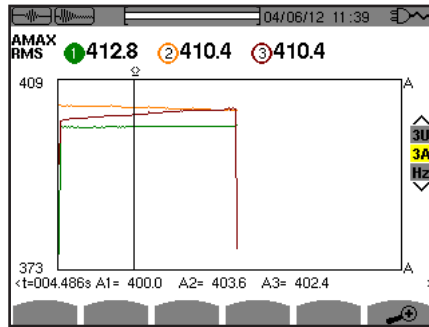
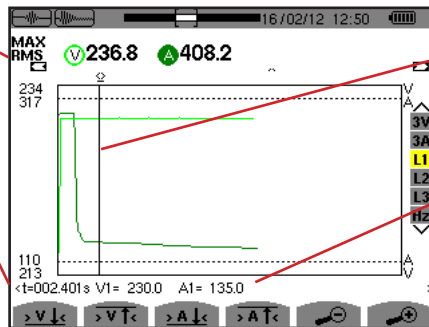

Figure 45: The 3A RMS display screen for a three-phase connection without neutral

5.2.3.3. The L1 RMS display screen for a three-phase connection with neutral

**MAX:** maximum half-cycle RMS value of the inrush current capture.

**t:** relative time position of the cursor (t=0 corresponds to the start of the inrush current capture).



Time cursor of the curve. Use the ◀ or ▶ key to move the cursor.

**V1:** RMS value of voltage 1 in the half-cycle at the position of the cursor.

**A1:** RMS value of current 1 in the half-cycle at the position of the cursor.

Figure 46: The L1 RMS display screen for a three-phase connection with neutral

**Note:** Filters L2 and L3 are used to display the recording of the true half-cycle RMS current and voltage of phases 2 and 3. The screen is identical to the one displayed for filter L1.

The >V↓, >V↑, >A↓ and >A↑ keys are used to go to the first occurrence of a minimum or maximum voltage or current value.

5.2.3.4. The RMS display screen in Hz for a three-phase connection without neutral

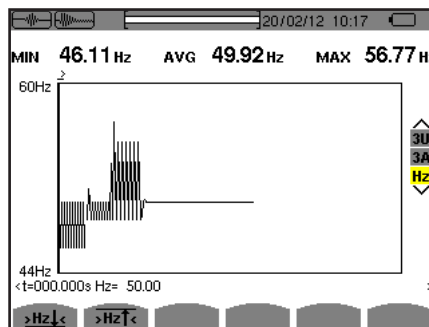

Figure 47: The Hz RMS display screen for a three-phase connection without neutral

The >Hz↓ and >Hz↑ keys are used to go to the first occurrence of a minimum or maximum frequency value.

### 5.2.4. INSTANTANEOUS INRUSH CURRENT

The **PEAK** mode is used to display the envelopes and waveforms of the inrush current capture.

The PEAK display of an inrush current capture provides two possible representations:

- envelope
- waveform.

The change from one of these representations to the other is automatic, as a function of the zoom level. If the zoom in is high enough, the representation is of the “waveform” type.

The display depends on the type of display filter:

- 4V**: displays the 4 voltages during the inrush current capture for set-ups with neutral (for a waveform type display only).
- 3U**: displays the 3 voltages during the inrush current capture for set-ups without neutral (for a waveform type display only).
- 4A**: displays the 4 currents during the inrush current capture (for a waveform type display only).
- L1, L2 or L3**: display the voltage and current of phases 1, 2, and 3, respectively (only for set-ups with neutral and for a waveform type display).
- N**: displays the neutral current and neutral voltage during the inrush current capture (for a waveform type display only).
- V1, V2, V3**: displays the 3 voltages during the inrush current capture for set-ups with neutral (for an envelope type display only).
- U1, U2, U3**: displays the 3 voltages during the inrush current capture for set-ups without neutral (for an envelope type display only).
- A1, A2, A3**: displays the 3 currents during the inrush current capture (for an envelope type display only).

Below, three examples of display.

#### 5.2.4.1. The 4A PEAK display screen for a 5-wire three-phase connection

Location of the zone displayed in the record.

**MAX IPEAKI**: maximum instantaneous absolute value of the inrush current capture.

Scale of values in amperes.

**t**: relative time position of the cursor (t=0 corresponds to the start of the inrush current capture).

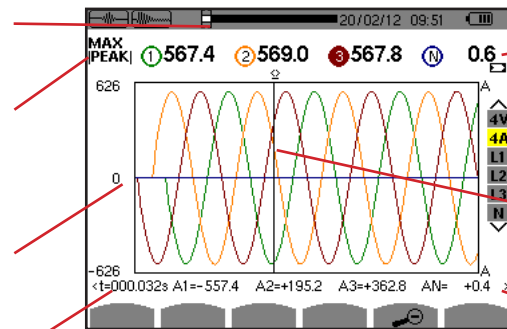

Reminder of number assigned to the curve displayed. Here, identification disc 3 is filled in to indicate that channel A3 triggered capture of the inrush current.

Time cursor. Use the ◀ or ▶ key to move the cursor.

**A1, A2, A3**: instantaneous values of currents 1, 2, and 3 at the position of the cursor.

Figure 48: The 4A PEAK display screen for a 5-wire three-phase connection

#### 5.2.4.2. The 3A PEAK display screen for a 3-wire three-phase connection

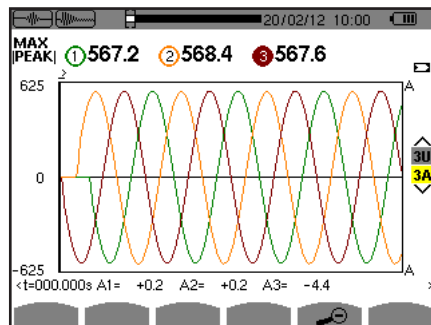

Figure 49: The 3A PEAK display screen for a 3-wire three-phase connection

### 5.2.4.3. The A1 PEAK display screen for a three-phase connection without neutral

In the case shown, there is enough zoom out to force the envelope type of representation.

**MAX IPEAKI:** maximum instantaneous absolute value of the inrush current capture.

**t:** relative time position of the cursor (t=0 corresponds to the start of the inrush current capture).

**A1:** maximum instantaneous current of the half-cycle identified by the cursor.

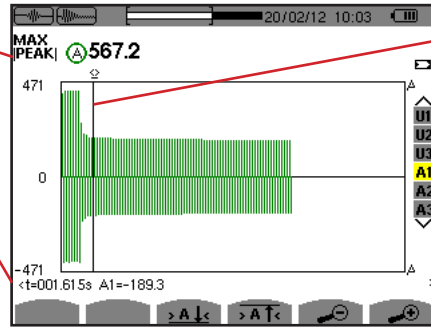

Time cursor of the curve. Use the ◀ or ▶ key to move the cursor.

Figure 50: The A1 PEAK display screen for a three-phase connection without neutral

**Note:** Filters A2 and A3 display the record of the current envelope of phases 2 and 3. The screen is identical to the one displayed for filter A1.

# 6. HARMONIC

The *Harmonic* mode displays a representation of the harmonic levels of the voltage, current, and apparent power, order by order. It can be used to determine the harmonic currents produced by nonlinear loads and analyze problems caused by harmonics according to their order (overheating of neutrals, conductors, motors, etc.).

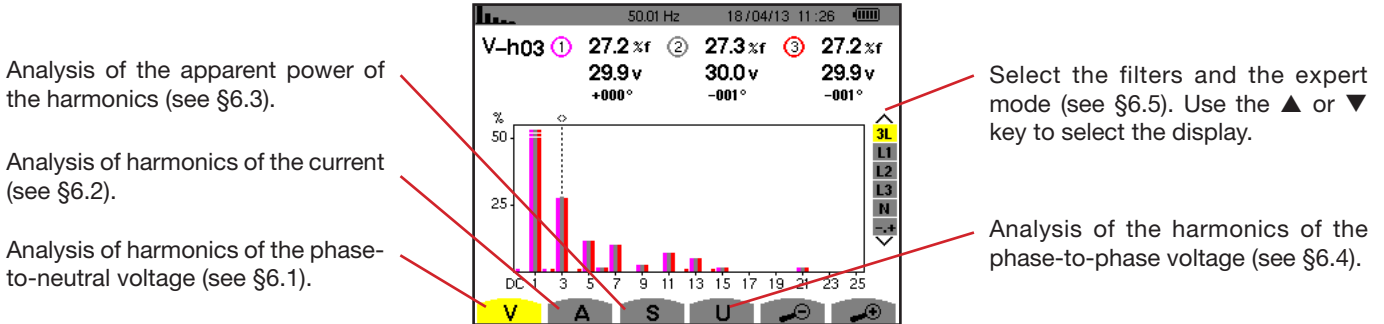

Analysis of the apparent power of the harmonics (see §6.3).

Analysis of harmonics of the current (see §6.2).

Analysis of harmonics of the phase-to-neutral voltage (see §6.1).

Select the filters and the expert mode (see §6.5). Use the ▲ or ▼ key to select the display.

Analysis of the harmonics of the phase-to-phase voltage (see §6.4).

Figure 51: Harmonics mode screen

## 6.1. PHASE-TO-NEUTRAL VOLTAGE

The **V** sub-menu displays the harmonics of the phase-to-neutral voltage only for sources having a neutral.

The choice of curves to be displayed depends on the type of connection (see §4.6):

- Single-phase, 2-wire: no choice (L1)
- Single-phase, 3-wire: L1, N
- Split-phase, 3-wire: 2L, L1, L2
- Split-phase, 4-wire: 2L, L1, L2, N
- Three-phase, 4-wire: 3L, L1, L2, L3, -,+,
- Three-phase, 5-wire: 3L, L1, L2, L3, N, -,+,

The screen captures shown as examples are those obtained with a 5-wire three-phase connection.

### 6.1.1. THE 3L PHASE-TO-NEUTRAL VOLTAGE HARMONICS DISPLAY SCREEN

This information concerns the harmonic pointed to by the cursor.

**V-h03**: harmonic number.

**%**: level of harmonics with the fundamental RMS value as reference (%f) or the (total) RMS value as reference (%r).

**V**: RMS voltage of the harmonic in question.

**+000°**: phase shift with respect to the fundamental (order 1).

Harmonic selection cursor. Use the ◀ or ▶ key to move the cursor.

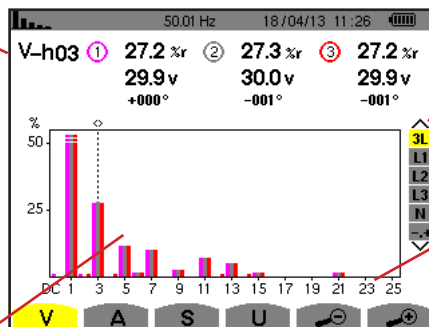

Display of the 3 phases 3L, of L1, L2, L3, N, or of the expert mode (three-phase connection only - see §6.5). To select the display press the ▲ or ▼ key.

The horizontal axis indicates the orders of the harmonics. The level of the harmonic is given as a percentage with respect to the fundamental or to the total RMS value.

**DC**: DC component. **1 to 25**: harmonics of order 1 to 25. When the cursor exceeds order 25, order 26 to 50 appears.

Figure 52: example of 3L phase-to-neutral voltage harmonics display

### 6.1.2. THE L1 PHASE VOLTAGE HARMONICS DISPLAY SCREEN

This information concerns the harmonic pointed to by the cursor.

**V-h03**: harmonic number.

**%**: level of harmonics with the fundamental RMS value as reference (%f) or the (total) RMS value as reference (%r).

**V**: RMS voltage of the harmonic in question.

**-143°**: phase shift with respect to the fundamental (order 1).

**max – min**: maximum and minimum levels of the harmonic in question. They are reset when the harmonic number is changed or the ↵ key is pressed.

**THD**: total harmonic distortion.

**Vd**: RMS distortion voltage.

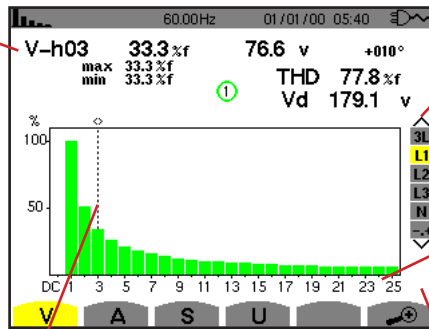

Harmonic selection cursor. Use the ◀ or ▶ key to move the cursor.

Display of the 3 phases 3L, of L1, L2, L3, N, or of the expert mode (three-phase connection only - see §6.5). To select the display press ▲ or ▼.

The horizontal axis indicates the orders of the harmonics. The level of the harmonic is given as a percentage with respect to the fundamental or to the total RMS value.

**DC**: DC component.

**1 to 25**: harmonics of order 1 to 25. When the cursor exceeds order 25, order 26 to 50 appears.

Indicator of the presence of non-zero harmonics of order higher than 25.

Figure 53: example of display of harmonics of L1 phase-to-neutral voltage

**Notes:** Filters L2 and L3 display the harmonics of the phase-to-neutral voltage for phases 2 and 3, respectively. The screen is identical to the one displayed for filter L1.

There is no phase shift or distortion value for the neutral channel.

## 6.2. CURRENT

The **A** sub-menu displays the harmonics of the current.

### 6.2.1. THE 3L CURRENT HARMONICS DISPLAY SCREEN

This information concerns the harmonic pointed to by the cursor.

**A-h05**: harmonic number.

**%**: level of harmonics with the fundamental RMS value as reference (%f) or the (total) RMS value as reference (%r).

**A**: RMS current of the harmonic in question.

**+179°**: phase shift with respect to the fundamental (order 1).

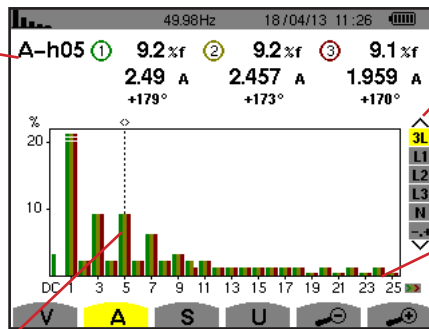

Harmonic selection cursor. Use the ◀ or ▶ key to move the cursor.

Display of the 3 phases 3L, of L1, L2, L3, N, or of the expert mode (three-phase connection only - see §6.5). To select the display press ▲ or ▼.

The horizontal axis indicates the orders of the harmonics. The level of the harmonic is given as a percentage with respect to the fundamental or to the total RMS value.

**Rang DC**: DC component.

**1 to 25**: harmonics of order 1 to 25. When the cursor exceeds order 25, order 26 to 50 appears.

Figure 54: example of 3L display of current harmonics

### 6.2.2. THE L1 CURRENT HARMONICS DISPLAY SCREEN

This information concerns the harmonic pointed to by the cursor.

**A-h05**: harmonic number.

**%**: level of harmonics with the fundamental RMS value as reference (%f) or the (total) RMS value as reference (%r).

**A**: RMS current of the harmonic in question.

**+178°**: phase shift with respect to the fundamental (order 1).

**max – min**: maximum and minimum levels of the harmonic in question. They are reset when the harmonic number is changed or the ↵ key is pressed

**THD**: total harmonic distortion.

**Ad**: RMS distortion current.

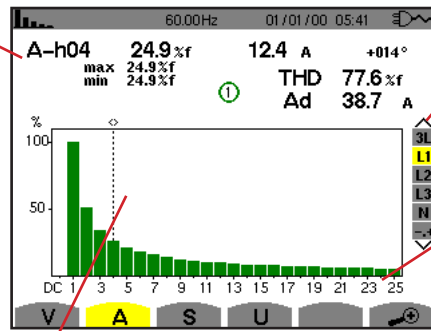

Harmonic selection cursor. Use the ◀ or ▶ key to move the cursor.

Display of the 3 phases 3L, of L1, L2, L3, N, or of the expert mode (three-phase connection only - see §6.5). To select the display press ▲ or ▼.

The horizontal axis indicates the orders of the harmonics. The level of the harmonic is given as a percentage with respect to the fundamental or to the total RMS value.

**Rang DC**: DC component.

**1 to 25**: harmonics of order 1 to 25. When the cursor exceeds order 25, order 26 to 50 appears.

Figure 55: example of L1 display of harmonics of current

**Notes:** Filters L2 and L3 display the current harmonics of phases 2 and 3, respectively. The screen is identical to the one displayed for filter L1.

There is no phase shift or distortion value for the neutral channel.

### 6.3. APPARENT POWER

The **S** sub-menu displays the harmonics of the apparent power, for all connections except 3-wire three-phase.

The horizontal axis indicates the orders of the harmonics. The bars of the bar chart above the horizontal centreline signify harmonic power consumed, those below it harmonic power generated.

#### 6.3.1. THE 3L APPARENT POWER HARMONICS DISPLAY SCREEN

This information concerns the harmonic pointed to by the cursor.

**S-h03**: harmonic number.

**%**: level of harmonics with the fundamental apparent power as reference (%f) or the (total) apparent power as reference (%r).

**+006°**: phase shift of the voltage harmonic with respect to the current harmonic for the order in question.

⚡: Indicator of energy generated for this harmonic.

⚡: Indicator of energy consumed for this harmonic.

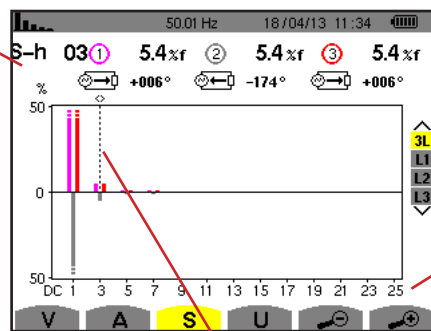

Harmonic selection cursor. Use the ◀ or ▶ key to move the cursor.

Display of the 3 phases 3L, of L1, L2 or L3. To select the display press the ▲ or ▼.

The horizontal axis indicates the orders of the harmonics. The level of the harmonic is given as a percentage of the fundamental apparent power or the (total) apparent power.

**Rang DC**: DC component.

**1 to 25**: harmonics of order 1 to 25. When the cursor exceeds order 25, order 26 to 50 appears.

Figure 56: example of 3L apparent power harmonics display

### 6.3.2. THE L1 APPARENT POWER HARMONICS DISPLAY SCREEN

This information concerns the harmonic pointed to by the cursor.  
**S-h03**: harmonic number.  
 %: level of harmonics with the fundamental apparent power as reference (%f) or the (total) apparent power as reference (%r).  
**+045°**: phase shift of the voltage harmonic with respect to the current harmonic for the order in question.  
**min-max**: maximum and minimum levels of the harmonic in question. They are reset when the harmonic number is changed or the ↵ key is pressed.

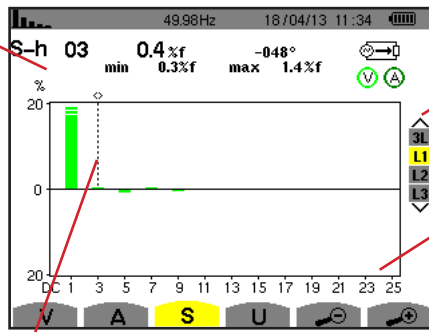

Harmonic selection cursor. Use the ◀ or ▶ key to move the cursor.

Display of the 3 phases 3L, of L1, L2 or L3. To select the display press the ▲ or ▼.

The horizontal axis indicates the orders of the harmonics. The level of the harmonic is given as a percentage of the fundamental apparent power or the (total) apparent power.  
**Rang DC**: DC component.  
**1 to 25**: harmonics of order 1 to 25. When the cursor exceeds order 25, order 26 to 50 appears.  
 ⚡ Indicator of energy consumed for this harmonic.

Figure 57: example of L1 apparent power of harmonics display

**Note:** Filters L2 and L3 display the apparent power of the harmonics for phases 2 and 3, respectively. The screen is identical to the one displayed for filter L1.

## 6.4. PHASE-TO-PHASE VOLTAGE

The **U** sub-menu is available for all connections except 2- or 3-wire single-phase.. This sub-menu displays the harmonics of the phase-to-phase voltage.

### 6.4.1. THE 3L PHASE-TO-PHASE VOLTAGE HARMONICS DISPLAY SCREEN

This information concerns the harmonic pointed to by the cursor.  
**U-h03**: harmonic number.  
 %: level of harmonics with the fundamental RMS value as reference (%f) or the (total) RMS value as reference (%r).  
**V**: RMS voltage of the harmonic in question.  
**+000°**: phase shift with respect to the fundamental (order 1).

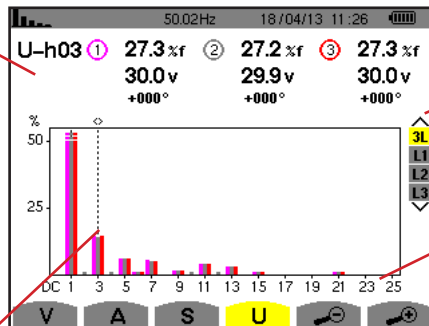

Harmonic selection cursor. Use the ◀ or ▶ key to move the cursor.

Display of the 3 phases 3L, of L1, L2, L3. To select the display press the ▲ or ▼.

The horizontal axis indicates the orders of the harmonics. The level of the harmonic is given as a percentage with respect to the fundamental or to the total RMS value.  
**Rang DC**: DC component.  
**1 to 25**: harmonics of order 1 to 25. When the cursor exceeds order 25, order 26 to 50 appears.

Figure 58: example of 3L phase-to-phase voltage harmonics display

### 6.4.2. THE L1 PHASE-TO-PHASE VOLTAGE HARMONICS DISPLAY SCREEN

This information concerns the harmonic pointed to by the cursor.

- Uh 03:** harmonic number.
- %:** level of harmonics with the fundamental RMS value as reference (%f) or the (total) RMS value as reference (%r).
- V:** RMS voltage of the harmonic in question.
- +000°:** phase shift with respect to the fundamental (order 1).
- max – min:** indicators of the maximum and minimum of the level of harmonics or by pressing the  $\leftarrow$  key.
- THD:** total harmonic distortion.
- Ud:** phase-to-phase RMS distortion voltage.

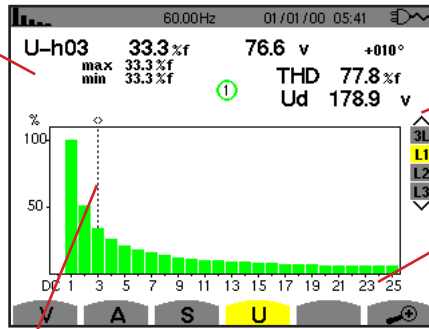

Harmonic selection cursor. Use the  $\leftarrow$  or  $\rightarrow$  key to move the cursor.

Display of the 3 phases 3L, of L1, L2 or L3. To select the display press  $\blacktriangle$  or  $\blacktriangledown$ .

The horizontal axis indicates the orders of the harmonics. The level of the harmonic is given as a percentage with respect to the fundamental or to the total RMS value.

**Rang DC:** DC component.  
**1 to 25:** harmonics of order 1 to 25. When the cursor exceeds order 25, order 26 to 50 appears.

Figure 59: example of L1 phase-to-phase voltage harmonics display

**Note:** Filters L2 and L3 display the phase-to-phase voltage harmonics for phases 2 and 3, respectively. The screen is identical to the one displayed for filter L1.

### 6.5. EXPERT MODE

The  $\leftarrow$  Expert mode is available with a three-phase connection only. It is used to display the influence of the harmonics on the heating of the neutral and on rotating machines. To display expert mode press the  $\blacktriangle$  or  $\blacktriangledown$  key of the keypad. The selection is highlighted in yellow and the screen simultaneously displays the expert mode.

From this screen, two sub-menus are available:

- **V** for three-phase set-ups with neutral or **U** for the three-phase set-up without neutral.
- **A** for the expert mode in current.

**Note :** The breakdown into sequences shown here is valid only in the case of a balanced load.

#### 6.5.1. THE PHASE-TO-NEUTRAL VOLTAGE EXPERT MODE DISPLAY SCREEN

For three-phase set-ups with neutral, the **V** sub-menu displays the

influence of the harmonics of the phase-to-neutral voltage on the

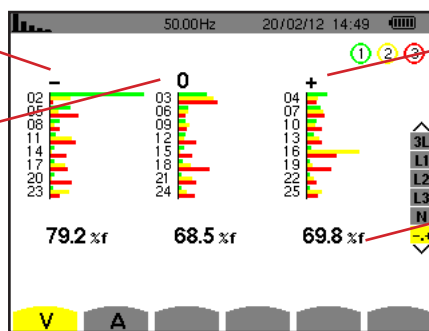

heating of the neutral and on rotating machines.

Harmonics inducing a negative sequence.  
 Harmonics inducing a zero sequence.

Harmonics inducing a positive sequence.

**%:** level of harmonics with the fundamental RMS value as reference (%f) or the (total) RMS value as reference (%r).

Figure 60: The phase-to-neutral voltage expert mode screen (three-phase set-ups with neutral)

For three-phase set-ups without neutral, the **U** sub-menu displays the influence of the harmonics of the phase-to-phase voltage on the heating of revolving machines.



### 6.5.2. THE CURRENT EXPERT MODE DISPLAY SCREEN

The **A** sub-menu displays the influence of the harmonics of the current on the heating of the neutral and on rotating machines.

Harmonics inducing a negative sequence.

Harmonics inducing a zero sequence.

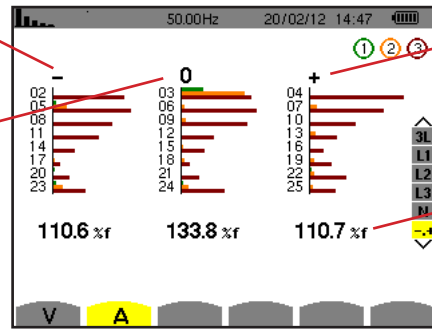

Harmonics inducing a positive sequence.

‰: level of harmonics with the fundamental RMS value as reference (%f) or the (total) RMS value as reference (%r).

Figure 61: the current expert mode screen

## 7. WAVEFORM

The  *Waveform* key is used to display the current and voltage curves, along with the values measured and those calculated from the voltages and currents (except for power, energy, and harmonics). This is the screen that appears when the device is powered up.

Display of the maximum and minimum RMS values and of the peak values (see §7.4).

Measurement of the peak factor (see §7.3).

Measurement of total harmonic distortion (see §7.2).

Measurement of the true RMS value (see §7.1).

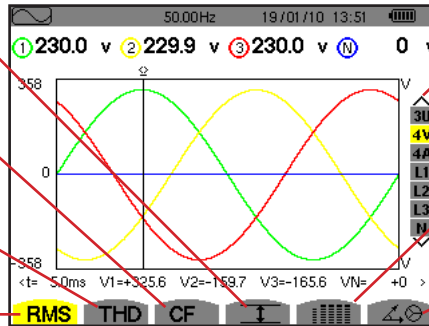

Selection of the display filters. Use the  $\blacktriangle$  or  $\blacktriangledown$  key to select the display.

Simultaneous display of the following measurements: RMS, DC, THD, CF, PST, PLT, FHL and FK (see §7.5)









Display of the Fresnel diagram of the signals (see §7.6).

Figure 62: Waveform mode screen

### 7.1. MEASUREMENT OF TRUE RMS VALUE

The **RMS** sub-menu displays the waveforms over one period of the signals measured and the true RMS voltage and current.

The choice of curves to be displayed depends on the type of connection (see §4.6):

- Single-phase, 2-wire or Split-phase, 2-wire: no choice (L1)
- Single-phase, 3-wire:
  - For **RMS**, **THD**, **CF**,  and : 2V, 2A, L1, N
  - For  $\Delta$  or  $\star$ : no choice (L1)
- Split-phase, 3-wire:
  - For **RMS**, **THD**, **CF**,  and : U, 2V, 2A, L1, L2
  - For  $\Delta$  or  $\star$ : 2V, 2A, L1, L2
- Split-phase, 4-wire:
  - For **RMS**, **THD**, **CF**,  and : U, 3V, 3A, L1, L2 N
  - For  $\Delta$  or  $\star$ : 2V, 2A, L1, L2
- Three-phase, 3wire: 3U, 3A
- Three-phase, 4-wire: 3U, 3V, 3A, L1, L2, L3
- Three-phase, 5-wire:
  - For **RMS**, **THD**, **CF**,  and : 3U, 4V, 4A, L1, L2, L3 and N
  - For:  $\Delta$  or  $\star$  3U, 3V, 3A, L1, L2 and L3

The screen snapshots shown as examples are those obtained with a three-phase 5-wire connection.

### 7.1.1. THE 3U RMS DISPLAY SCREEN

This screen displays the three phase-to-neutral voltages of a three-phase system.

RMS phase-to-phase voltages.  
Voltage axis with automatic scaling.  
Instantaneous value cursor. Use the ◀ or ▶ key to move the cursor.

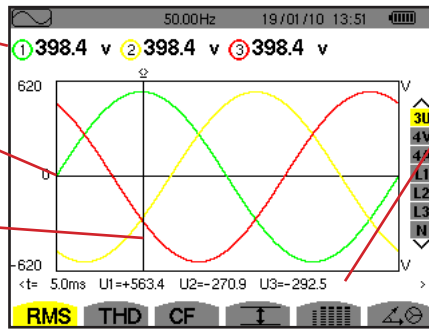

Instantaneous values of the signals at the position of the cursor.  
**t**: time relative to the start of the period.  
**U1**: instantaneous phase-to-phase voltage between phases 1 and 2 ( $U_{12}$ ).  
**U2**: instantaneous phase-to-phase voltage between phases 2 and 3 ( $U_{23}$ ).  
**U3**: instantaneous phase-to-phase voltage between phases 3 and 1 ( $U_{31}$ ).

Figure 63: The 3U RMS display screen

### 7.1.2. THE 4V RMS DISPLAY SCREEN

This screen displays the three phase-to-neutral voltages and the neutral-to-earth voltage of a three-phase system.

RMS voltages.  
Voltage axis with automatic scaling.  
Instantaneous value cursor. Use the ◀ or ▶ key to move the cursor.

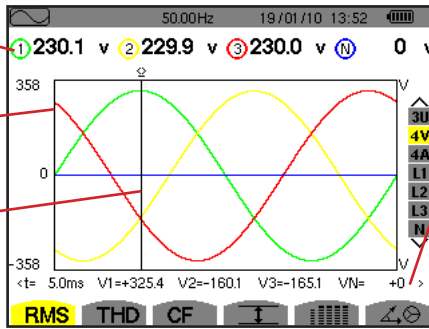

Instantaneous values of the signals at the position of the cursor.  
**t**: time relative to the start of the period.  
**V1**: instantaneous phase-to-neutral voltage of curve 1.  
**V2**: instantaneous phase-to-neutral voltage of curve 2.  
**V3**: instantaneous phase-to-neutral voltage of curve 3.  
**VN**: instantaneous value of the neutral voltage.

Figure 64: The 4V RMS display screen

### 7.1.3. THE 4A RMS DISPLAY SCREEN

This screen displays the three phase currents and the neutral current of a three-phase system.

RMS currents.  
Current axis with automatic scaling.  
Instantaneous value cursor. Use the ◀ or ▶ key to move the cursor.

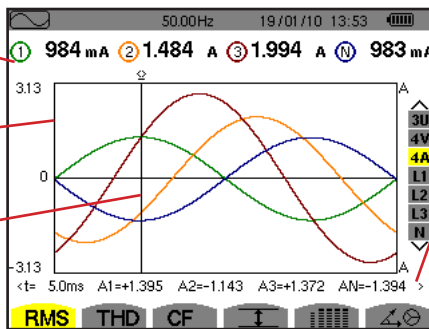

Instantaneous values of the signals at the intersection of the cursor and of the curves.  
**t**: time relative to the start of the period.  
**A1**: instantaneous current of phase 1.  
**A2**: instantaneous current of phase 2.  
**A3**: instantaneous current of phase 3.  
**AN**: instantaneous value of the neutral current.

Figure 65: The 4A RMS display screen

### 7.1.4. THE RMS DISPLAY SCREEN FOR THE NEUTRAL

This screen displays the neutral voltage with respect to earth and the neutral current.

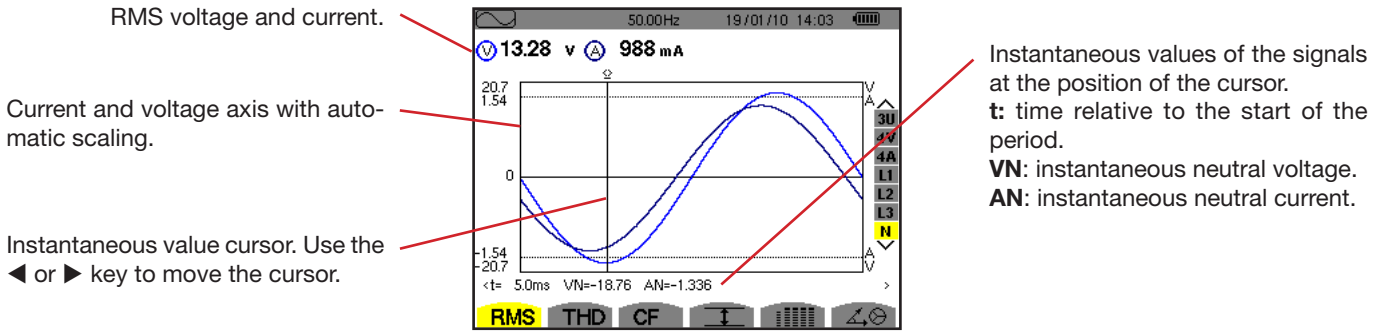

Figure 66: The RMS display screen for the neutral

**Note:** Filters L1, L2, and L3 display the current and voltage in phases 1, 2, and 3, respectively. The screen is identical to the one displayed for the neutral.

## 7.2. MEASUREMENT OF TOTAL HARMONIC DISTORTION

The **THD** sub-menu displays the waveforms of the signals measured over one full cycle and the total voltage and current harmonic distortion. The levels are displayed either with the fundamental RMS value as reference (%f) or with the RMS value without DC as reference (%r), depending on which reference is chosen in the configuration menu.

### 7.2.1. THE 3U THD DISPLAY SCREEN

This screen displays the phase-to-phase voltage waveforms for one period and the total harmonic distortion values.

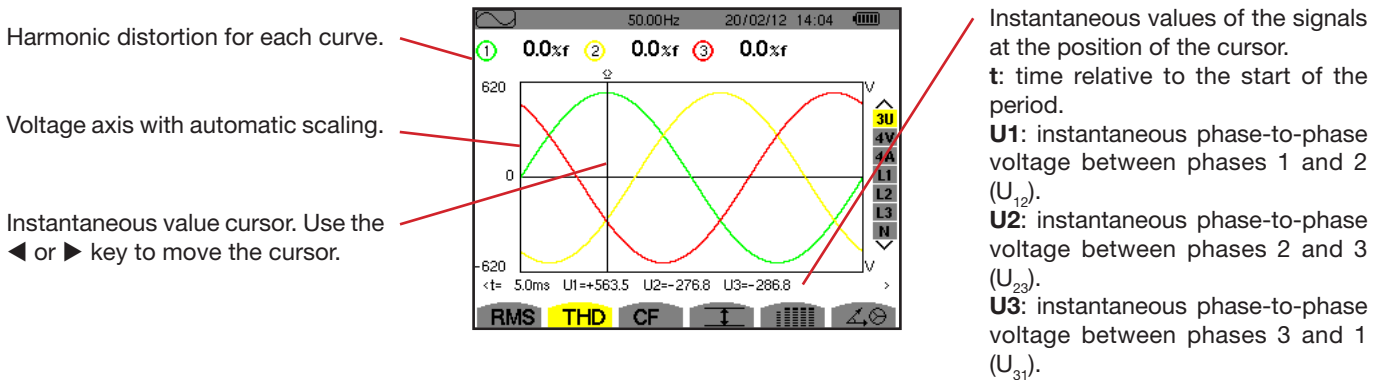

Figure 67: The 3U THD display screen en 3U

### 7.2.2. THE 4V THD DISPLAY SCREEN

This screen displays the phase-to-neutral voltage waveforms for one period and the total harmonic distortion values.

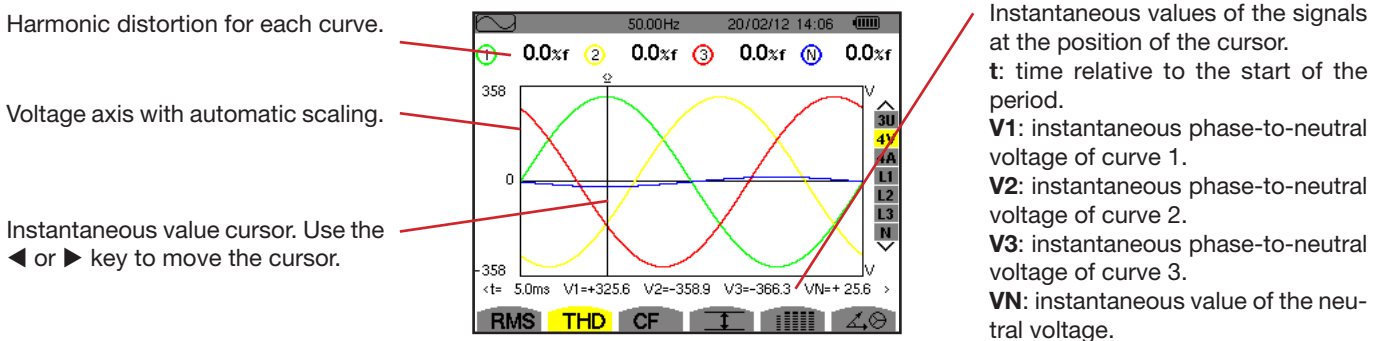

Figure 68: the 4V THD display screen

### 7.2.3. THE 4A THD DISPLAY SCREEN

This screen displays the phase current waveforms for one period and the total harmonic distortion values.

Harmonic distortion for each curve.

Current axis with automatic scaling.

Instantaneous value cursor. Use the ◀ or ▶ key to move the cursor.

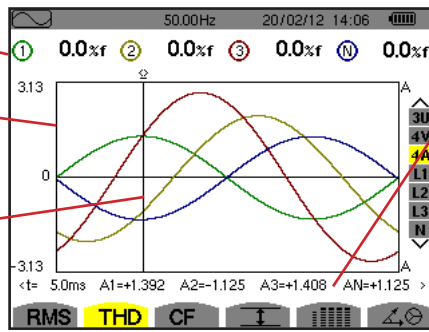

Instantaneous values of the signals at the position of the cursor.  
**t**: time relative to the start of the period.  
**A1**: instantaneous current of phase 1.  
**A2**: instantaneous current of phase 2.  
**A3**: instantaneous current of phase 3.  
**AN**: instantaneous value of the neutral current.

Figure 69: The 4A THD display screen

**Note:** Filters L1, L2, L3 and N display the total current and voltage harmonic distortion for phases 1, 2 and 3 and the neutral channel.

## 7.3. MEASUREMENT OF THE PEAK FACTOR

The CF sub-menu displays the waveforms of the signals measured over one period and the voltage and current peak factors.

### 7.3.1. THE 3U CF DISPLAY SCREEN

This screen displays the phase-to-phase voltage waveforms of one period and the peak factors.

Peak factor for each curve.

Voltage axis with automatic scaling.

Instantaneous value cursor. Use the ◀ or ▶ key to move the cursor.

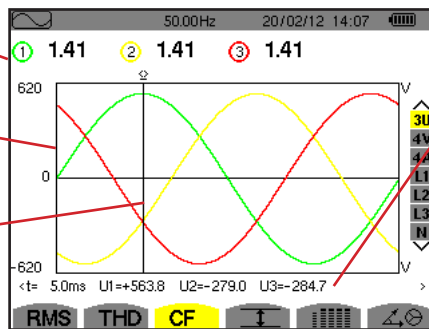

Instantaneous values of the signals at the position of the cursor.  
**t**: time relative to the start of the period.  
**U1**: instantaneous phase-to-phase voltage between phases 1 and 2 ( $U_{12}$ ).  
**U2**: instantaneous phase-to-phase voltage between phases 2 and 3 ( $U_{23}$ ).  
**U3**: instantaneous phase-to-phase voltage between phases 3 and 1 ( $U_{31}$ ).

Figure 70: The 3U CF display screen

### 7.3.2. THE 4V CF DISPLAY SCREEN

This screen displays the phase-to-neutral voltage waveforms of one period and the peak factors.

Peak factor for each curve.

Voltage axis with automatic scaling.

Instantaneous value cursor. Use the ◀ or ▶ key to move the cursor.

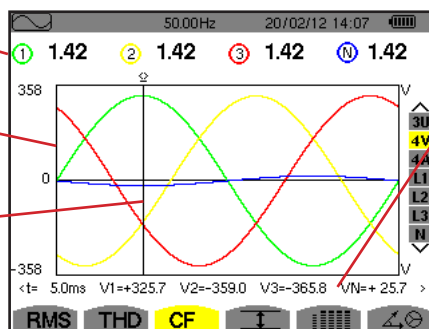

Instantaneous values of the signals at the position of the cursor.  
**t**: time relative to the start of the period.  
**V1**: instantaneous phase-to-neutral voltage of curve 1.  
**V2**: instantaneous phase-to-neutral voltage of curve 2.  
**V3**: instantaneous phase-to-neutral voltage of curve 3.  
**VN**: instantaneous value of the phase-to-neutral voltage of the neutral.

Figure 71: The 3V CF display screen

### 7.3.3. THE 4A CF DISPLAY SCREEN

This screen displays the current waveforms of one period and the peak factors.

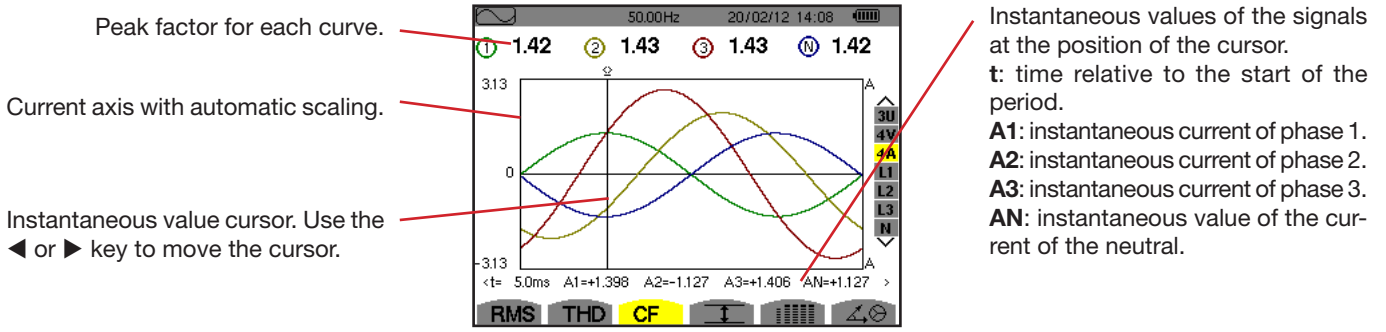

Figure 72: The 4A CF display screen

**Note:** L1, L2, L3 and N display the current and voltage peak factors for phases 1, 2 and 3, respectively and the neutral channel.

## 7.4. MEASUREMENT OF EXTREME AND MEAN VOLTAGE AND CURRENT

The  $\bar{I}$  sub-menu displays the one-second mean and half-cycle maximum and minimum RMS voltage and current and the instantaneous positive and negative peak voltage and current.

**Note:** The MAX. and MIN. RMS measurements are calculated every half cycle (i.e. every 10 ms for a 50-Hz signal). The measurements are refreshed every 250 ms.

The RMS measurements are calculated over one second.

### 7.4.1. THE 3U MAX.-MIN. DISPLAY SCREEN

This screen displays the one-second mean and half-cycle maximum and minimum RMS values and the positive and negative phase-to-phase voltage peaks.

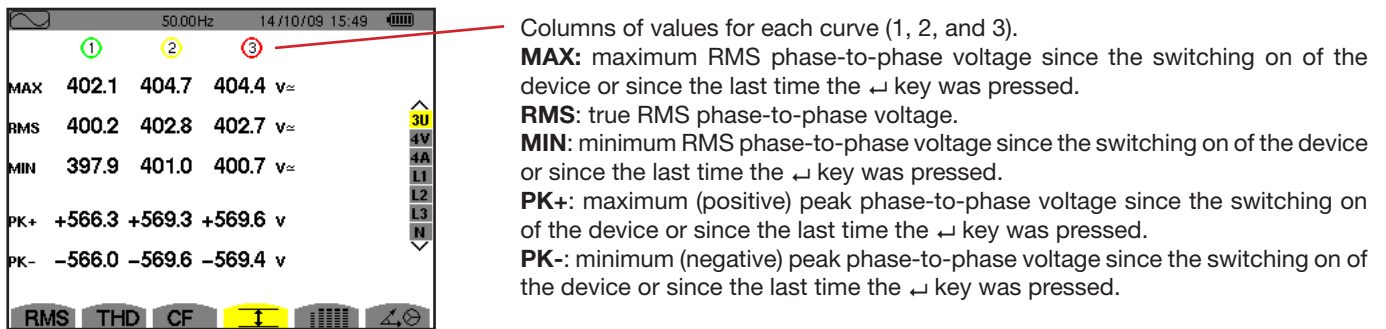
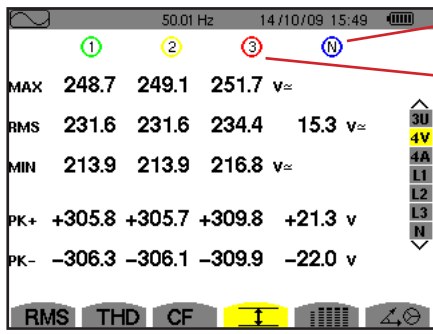

Figure 73: The 3U Max.-Min. display screen

### 7.4.2. THE 4V MAX.-MIN. DISPLAY SCREEN

This screen displays the one-second mean and half-cycle maximum and minimum RMS values and the positive and negative peaks of the phase-to-neutral voltages and of the neutral.



Column of values for the neutral: RMS, PEAK+ and PEAK- parameters.

Columns of values for each voltage curve (1, 2 and 3).

**MAX:** maximum RMS phase-to-neutral voltage since the switching on of the device or since the last time the ↵key was pressed.

**RMS:** true RMS phase-to-neutral voltage.

**MIN:** minimum RMS phase-to-neutral voltage since the switching on of the device or since the last time the ↵key was pressed.

**PK+:** maximum peak phase-to-neutral voltage since the switching on of the device or since the last time the ↵key was pressed.

**PK-:** minimum peak phase-to-neutral voltage since the switching on of the device or since the last time the ↵key was pressed.

Figure 74: The 4V Max.-Min. display screen

### 7.4.3. THE 4A MAX.-MIN. DISPLAY SCREEN

This screen displays the one-second mean and half-cycle maximum and minimum RMS values and the positive and negative peak values of the phase and neutral currents.

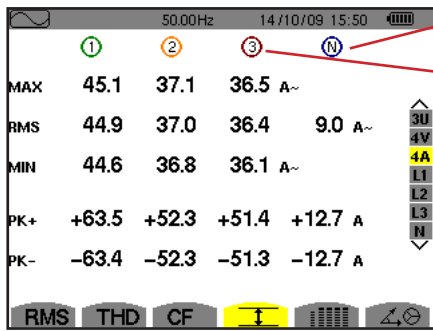

Column of values for the neutral: RMS, PEAK+ and PEAK- parameters.

Columns of values for each current curve (1, 2 and 3).

**MAX:** maximum RMS current since the switching on of the device or since the last time the ↵key was pressed.

**RMS:** true RMS current.

**MIN:** minimum RMS current since the switching on of the device or since the last time the ↵key was pressed.

**PK+:** maximum peak current since the switching on of the device or since the last time the ↵key was pressed.

**PK-:** minimum peak current since the switching on of the device or since the last time the ↵key was pressed.

Figure 75: The 4A Max.-Min. display screen

### 7.4.4. THE L1 MAX.-MIN. DISPLAY SCREEN

This screen displays the one-second mean and half-cycle maximum and minimum RMS values and the positive and negative peaks of the phase-to-neutral voltage and of the current of phase 1.

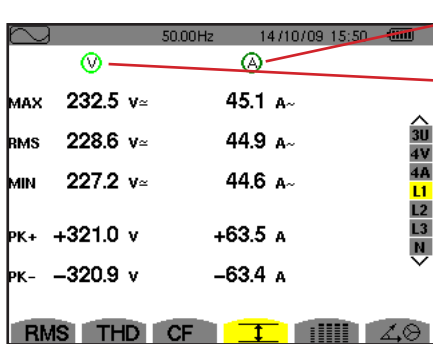

The same information as for the phase-to-neutral voltage, but for the current.

Column of voltage values.

**MAX:** maximum RMS phase-to-neutral voltage since the switching on of the device or since the last time the ↵key was pressed.

**RMS:** true RMS phase-to-neutral voltage.

**MIN:** minimum RMS phase-to-neutral voltage since the switching on of the device or since the last time the ↵key was pressed.

**PK+:** phase-to-neutral maximum peak voltage since the switching on of the device or since the last time the ↵key was pressed.

**PK-:** phase-to-neutral minimum peak voltage since the switching on of the device or since the last time the ↵key was pressed.

Figure 76: The L1 Max.-Min. display screen

**Note:** L2 and L3 display the RMS, maximum, minimum, and mean values and the positive and negative peak values of the phase-to-neutral voltage and of the current for phases 2 and 3, respectively.

### 7.4.5. THE NEUTRAL MAX.-MIN. DISPLAY SCREEN

This screen displays the RMS values and the positive and negative peaks of the neutral relative to earth.

Column of voltage values.

**RMS:** true RMS voltage.

**PK+:** maximum peak voltage since the switching on of the device or since the last time the ↵ key was pressed.

**PK-:** minimum peak voltage since the switching on of the device or since the last time the ↵ key was pressed.

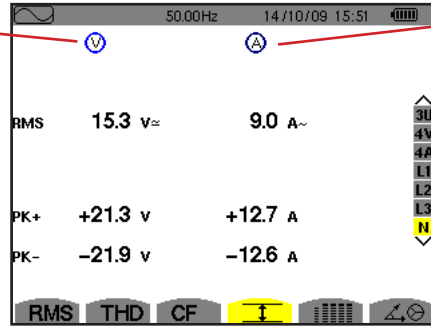

The same information as for the voltage, but for the current.

Figure 77: The neutral Max.-Min. display screen

## 7.5. SIMULTANEOUS DISPLAY

The  sub-menu displays all of the voltage and current measurements (RMS, DC, THD, CF, PST, PLT, FHL and FK).

### 7.5.1. 3U SIMULTANEOUS DISPLAY SCREEN

This screen displays the RMS, DC, THD, and CF values of the phase-to-phase voltages.

Column of phase-to-phase voltages (phases 1, 2, and 3).

**RMS:** true RMS value calculated over 1 second.

**DC:** DC component.

**THD:** total harmonic distortion with the fundamental RMS value as reference (%f) or with the total RMS value without DC as reference (%r).

**CF:** peak factor calculated over 1 second.

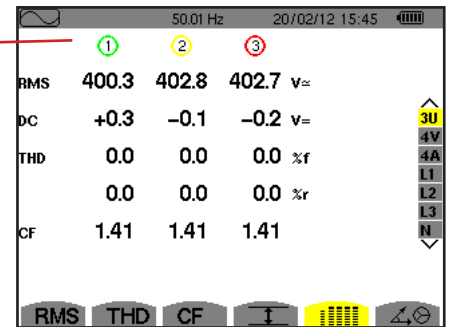

Figure 78: 3U simultaneous display screen

### 7.5.2. 4V SIMULTANEOUS DISPLAY SCREEN

This screen displays the RMS, DC, THD, CF, PST and PLT values of the phase-to-neutral voltages and of the neutral.

Column of RMS and DC values along with the CF and the THD (%r) concerning the neutral.

Column of voltages simple (phases 1, 2, and 3).

**RMS:** true RMS value calculated over 1 second.

**DC:** DC component.

**THD:** total harmonic distortion with the fundamental RMS value as reference (%f) or with the total RMS value without DC as reference (%r).

**CF:** peak factor calculated over 1 second.

**PST:** short-term flicker calculated over 10 minutes.

**PLT:** long-term flicker calculated over 2 hours.

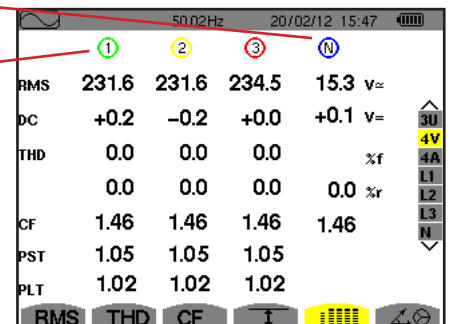

Figure 79: 4V simultaneous display screen



### 7.5.3. 4A SIMULTANEOUS DISPLAY SCREEN

This screen displays the RMS, DC (only if at least one of the current sensors can measure direct current), THD, CF, FHL and FK values of the phase and neutral currents.

Column of RMS values and (if the current sensor allows) DC values along with the CF and the THD (%) concerning the neutral.

Columns of current values (phases 1, 2 and 3).

**RMS:** true RMS value calculated over 1 second.

**DC:** DC component.

**THD:** total harmonic distortion with the fundamental RMS value as reference (%f) or with the total RMS value without DC as reference (%r).

**CF:** peak factor calculated over 1 second.

**FHL:** harmonic loss factor. For the oversizing of transformers to allow for harmonics.

**FK:** K factor. Derating of the transformer as a function of the harmonics.

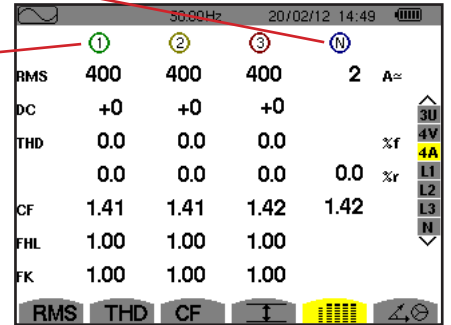

Figure 80: 4A simultaneous display screen

**Note:** To make it possible to adjust the zero of current sensors measuring DC, the DC values are never cancelled.

### 7.5.4. L1 SIMULTANEOUS DISPLAY SCREEN

This screen displays the RMS, DC, THD, and CF values of the phase-to-neutral voltage and of the current, PST and PLT of the phase-to-neutral voltage, and FHL and FK of the current for phase 1.

Column of voltage values simple.

**RMS:** true RMS value calculated over 1 second.

**DC:** DC component.

**THD:** total harmonic distortion with the fundamental RMS value as reference (%f) or with the total RMS value without DC as reference (%r).

**CF:** peak factor calculated over 1 second.

**PST:** short-term flicker calculated over 10 minutes.

**PLT:** long-term flicker calculated over 2 hours.

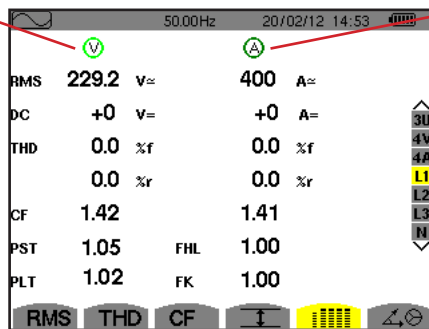

Current column.

RMS, DC (if the current sensor allows), THD and CF values.

**FHL:** harmonic loss factor. For the oversizing of transformers to allow for harmonics.

**FK:** K factor. Derating of the transformer as a function of the harmonics.

Figure 81: L1 simultaneous Display screen

**Notes:** The DC value of the current of phase 1 is displayed only if the associated current sensor can measure direct current.

L2 and L3 provide the simultaneous display of the current and voltage for phases 2 and 3, respectively.

### 7.5.5. SCREEN FOR SIMULTANEOUS DISPLAY OF NEUTRAL

This screen displays the RMS, THD and CF voltage and current of the neutral, the DC component of the neutral voltage, and (if the current sensor allows) the DC component of the neutral current.

## 7.6. DISPLAY OF FRESNEL DIAGRAM

The  $\Delta \oplus$  sub-menu displays a vector representation of the fundamentals of the voltages and currents. It indicates their associated quantities (modulus and phase of the vectors) and the negative-sequence voltage and current unbalance rates.

**Note:** To allow the display of all vectors, those of which the modulus is too small to be pictured are shown even so, but their name is followed by an asterisk (\*).

### 7.6.1. THE 3V FRESNEL DIAGRAM DISPLAY SCREEN

This screen displays a vector representation of the fundamentals of the phase-to-neutral voltages and of the currents. It indicates their associated quantities (modulus and phase of the phase-to-neutral voltage vectors) and the negative-sequence voltage unbalance rate. The reference vector of the representation (at 3 o'clock) is V1.

Column of values for each vector (1, 2, and 3).

**IV1, IV2 and IV3:** module of the vectors of the fundamentals of the phase-to-neutral voltages (phases 1, 2 and 3).

$\Phi_{12}$ : phase angle of the fundamental of phase 1 with respect to the fundamental of phase 2.

$\Phi_{23}$ : phase angle of the fundamental of phase 2 with respect to the fundamental of phase 3.

$\Phi_{31}$ : phase angle of the fundamental of phase 3 with respect to the fundamental of phase 1.

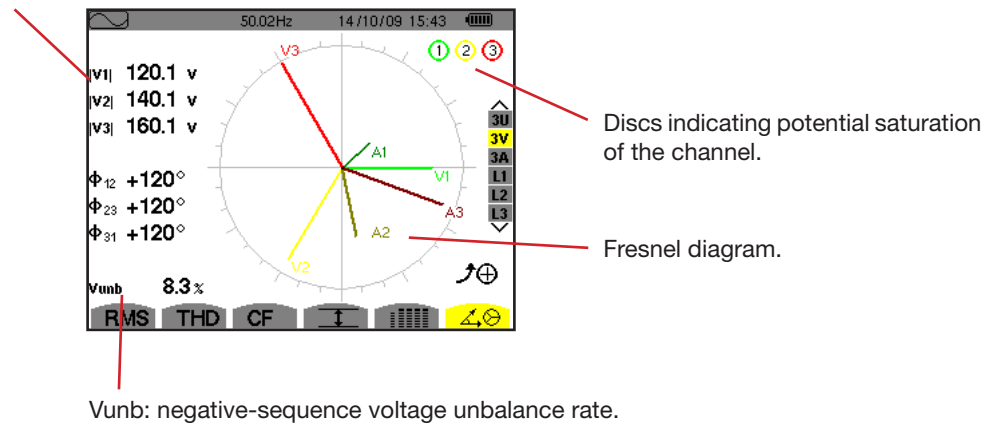

Figure 82: The screen Displaying the Fresnel diagram in 3V

### 7.6.2. THE 3U FRESNEL DIAGRAM DISPLAY SCREEN

This screen displays a vector representation of the fundamentals of the phase-to-phase voltages and of the currents. It indicates their associated quantities (modulus and phase of the phase-to-phase voltage vectors) and the negative-sequence voltage unbalance rate. The reference vector of the representation (at 3 o'clock) is U1.

The information displayed is identical to that described in §7.6.1 but relative to the phase-to-phase voltage.

### 7.6.3. THE 3A FRESNEL DIAGRAM DISPLAY SCREEN

For sources having a neutral, this screen displays the vector representation of the fundamental component of the phase-to-neutral voltages and of the current. For 3-wire three-phase (source without neutral), this screen displays only the vector representation of the fundamental components of the current. It indicates their associated quantities (modulus and phase of the current vectors) and negative-sequence current unbalance rate. The reference vector of the representation (at 3 o'clock) is A1.

The information displayed is identical to that described in §7.6.1 but relative to the current.

### 7.6.4. THE L1 FRESNEL DIAGRAM DISPLAY SCREEN

In the presence of the neutral, this screen displays a vector representation of the fundamentals of the phase-to-neutral voltages and the currents of one phase. It indicates their associated quantities (modulus and phase of the current and phase-to-neutral voltage vectors). The reference vector of the representation (at 3 o'clock) is the current vector.

**$I_{V1}$** : modulus of the vector of the fundamental of the phase-to-neutral voltage of phase 1.  
 **$I_{A1}$** : modulus of the vector of the fundamental of the current of phase 1.

$\Phi_{VA}$ : phase angle of the fundamental of the phase-to-neutral voltage of phase 1 relative to the fundamental of the current of phase 1.

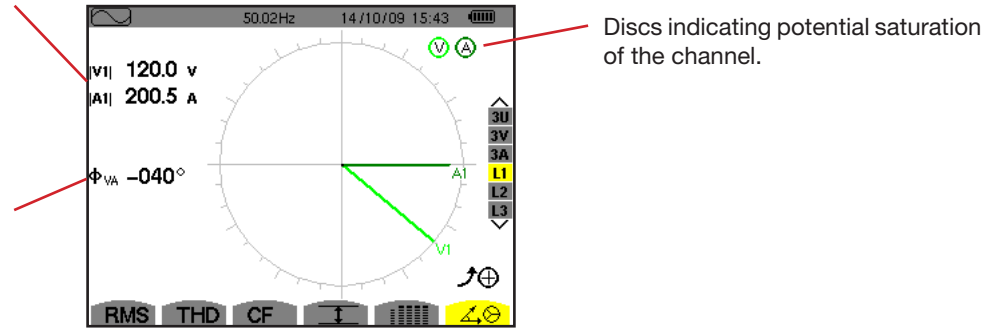

Figure 83: The L1 Fresnel diagram display screen

**Note:** L2 and L3 display vector representations of the fundamentals of the phase-to-neutral voltages and the currents of phases 2 and 3, respectively. They indicate their associated quantities (modulus and phase of the current and phase-to-neutral voltage vectors of phases 2 and 3, respectively). The reference vector of the representation (at 3 o'clock) is the current vector (A2 and A3, respectively).

In the absence of the neutral (2-wire two-phase):

**$I_{U1}$** : modulus of the vector of the fundamental component of the phase-to-phase voltage between phases 1 and 2 ( $U_{12}$ ).  
 **$I_{A1}$** : modulus of the vector of the fundamental of the current of phase 1.

$\Phi_{UA}$ : phase shift of the fundamental component of the phase-to-phase voltage between phases 1 and 2 ( $U_{12}$ ) with respect to the fundamental component of the current of phase 1.

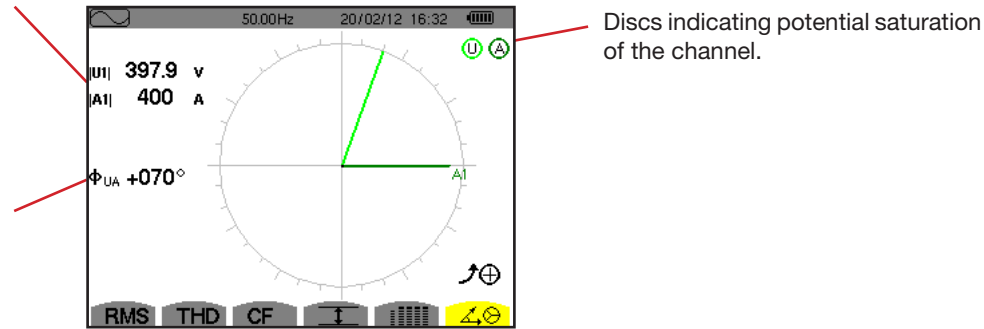



Figure 84: the Fresnel diagram display screen in 2-wire two-phase

## 8. ALARM MODE

The  Alarm mode detects overshoots of thresholds on each of the following parameters: Hz, Urms, Vrms, Arms, IUdcl, IVdcl, IAdcl, IUpk+l, IVpk+l, IApk+l, IUpk-l, IVpk-l, IApk-l, Ucf, Vcf, Acf, Uthdf, Vthdf, Athdf, Uthdr, Vthdr, Athdr, IPI, IPdcl, IQ<sub>1</sub> or N, D, S, IPFI, Icos Φl, Itan Φl, PST, PLT, FHL, FK, Vunb, Uunb (for a three-phase source without neutral) Aunb, U-h, V-h, A-h and IS-hl (see the table of abbreviations in §2.9).



The alarm thresholds:

- must have been programmed in the *Configuration / Alarm mode* screen (see §4.10).
- must be active (marked with a red spot on that same screen).

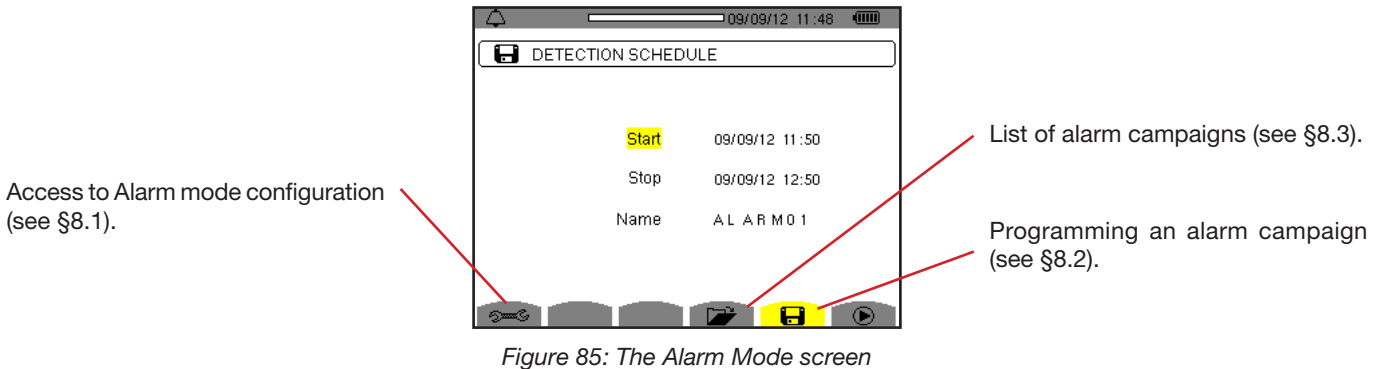
Stored alarms can subsequently be transferred to a PC via the PAT2 application (see §13). You can capture over 16,000 alarms.



The  and  icons have the following functions:

- : Validating the programming of a campaign and starting the alarm campaign.
- : Voluntary stoppage of alarm campaign.

### 8.1. ALARM MODE CONFIGURATION

The  submenu displays the list of alarms configured (see §4.10). This shortcut key lets you define or change alarm configurations.

The following information is displayed.

Press  to return to the Programming a campaign screen.

### 8.2. PROGRAMMING AN ALARM CAMPAIGN

The  submenu is used to specify the start and stop times for an alarm campaign (see figure 66).

To program an alarm campaign, enter the start date and time, the stop date and time, and the name of the campaign.





To modify an item, move the yellow cursor to it using the  and  keys, then validate with the  key. Change the value using the  and  keys, then validate again.

The name can be at most 8 characters long. Several campaigns may have the same name. The available alphanumeric characters are the uppercase letters from A to Z and the digits from 0 to 9. The last 5 names given (in the transient, trend, and alarm modes) are kept in memory. When a name is entered, it may then be completed automatically.

**Notes:** The start date and time must be later than the current date and time.

The stop date and time must be later than the start date and time.

It is not possible to program an alarm campaign if an inrush current capture is in progress.

Once the programming is done, start the campaign by pressing the  key. The  icon of the status bar blinks to indicate that the campaign has been started. The  key replaces the  key and can be used to stop the campaign before it is finished. Alarms in progress (not yet ended) are recorded in the campaign if their duration is equal to or greater than their programmed minimum duration.

The *Campaign on standby* message is displayed until the start time is reached. It is then replaced by the message *Campaign running*. When the stop time is reached, the *Programming a Campaign* screen returns with the key. You can then program another campaign.

During an alarm campaign, only the stop date field can be modified. It is automatically highlighted in yellow.

### 8.3. DISPLAY OF THE LIST OF CAMPAIGNS

To display the list of campaigns performed, press the key. The *List of Alarm Campaigns* screen is displayed. The list can contain up to 7 campaigns.

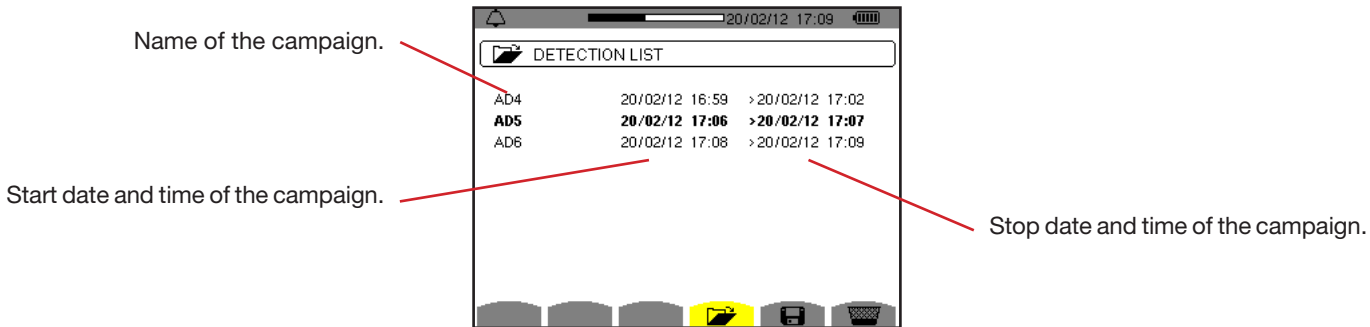

Figure 86: list of campaigns display screen

If the stop date of the campaign is in red, it means that it does not match the stop date initially programmed:

- either because of a power supply problem (battery low or disconnection of the device supplied by mains only),
- or because the memory is full.

### 8.4. DISPLAY OF LIST OF ALARMS

To select a campaign, move the cursor to it using the and keys. The selected field is bolded. Then validate with the key. The device then displays the alarms in list form.

Level of filling dedicated to the alarm mode. The black part of the bar corresponds to the fraction of memory used.

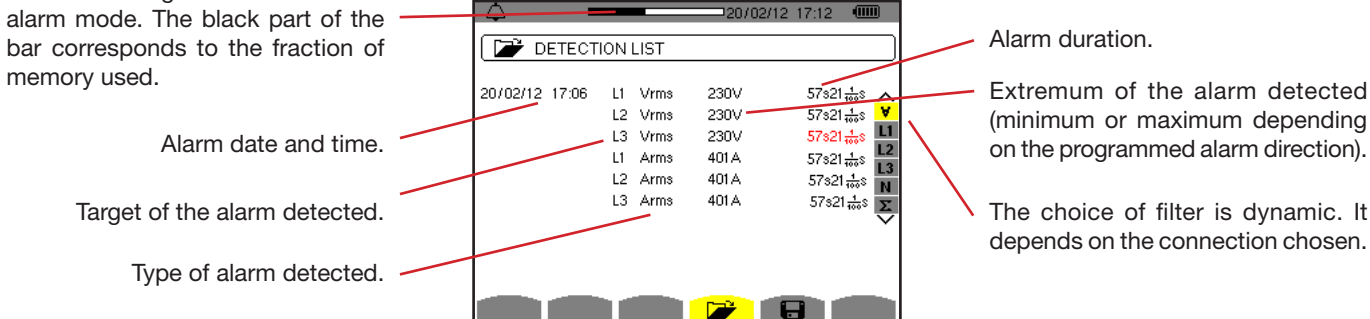

Figure 87: Alarm list screen

If an alarm duration is displayed in red, it means that it was cut short:

- because of a power supply problem (battery low),
- or because of a manual stoppage of the campaign (press on ) or deliberate switching off of the device (press on the key).
- or because the memory is full.
- or because of a measurement error.
- or because of an incompatibility between the quantity monitored and the configuration of the device (for example withdrawal of a current sensor).

In the last two cases, the extremum is also displayed in red.

To return to the *List of campaigns* screen, press .

## 8.5. DELETING AN ALARM CAMPAIGN

When the list of campaigns performed is displayed (see figure 86), select the campaign to be erased. This is done by moving the cursor to it using the ▲ and ▼ keys. The selected campaign is bolded.

Then press the  key. Press ↵ to validate or ↶ to cancel.

**Note:** It is not possible to delete the alarm campaign in progress.

## 8.6. ERASING ALL ALARM CAMPAIGNS

Erasing all of the alarm campaigns is possible only from the Configuration menu, in the *Erasure of Data* sub-menu (see §4.11)

## 9. TREND MODE

The  *Trend* mode records changes to parameters previously specified in the *Configuration / Trend mode* screen (see §4.9). This mode manages up to 2 GB of data.

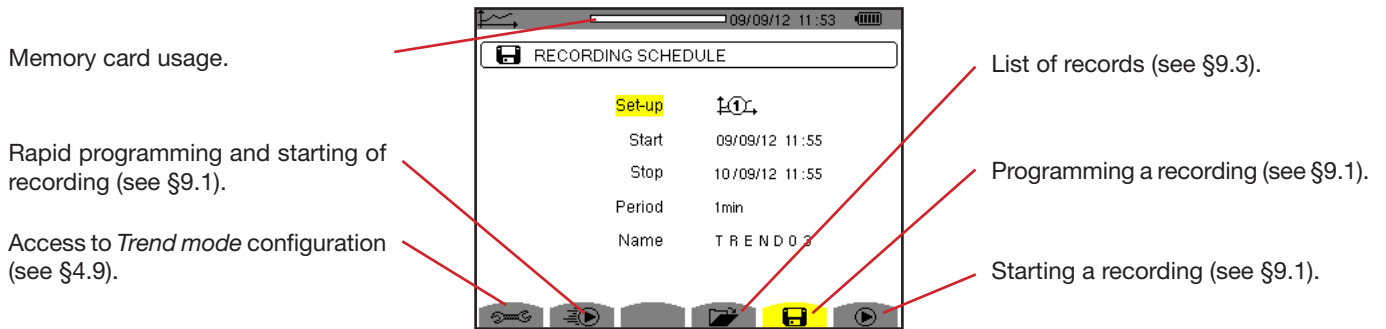





Figure 88: Trend mode screen

### 9.1. PROGRAMMING AND STARTING RECORDING

The  submenu specifies the characteristics of a recording (see figure 88).

To start a recording rapidly, press the  key. Recording starts immediately; all measurements are recorded every second until the memory or completely full. The configuration displayed is .

To program recording, before starting it, choose configuration  to , enter the start date and time, the stop date and time, the period, and the name of the recording.





To modify an item, move the yellow cursor to it using the  and  keys, then validate with the  key. Change the value using the , ,  and  keys, then validate again.

The integration period is the time over which the measurements of each recorded value are averaged (arithmetic mean). Possible values for the period are: 1 s, 5 s, 20 s, 1 min, 2 min, 5 min, 10 min and 15 min.

The name can be at most 8 characters long. Several recordings may have the same name. The available alphanumeric characters are the uppercase letters from A to Z and the digits from 0 to 9. The last 5 names given (in the transient, trend, and alarm modes) are kept in memory. When a name is entered, it may then be completed automatically.

**Notes:** The start date and time must be later than the current date and time.

The stop date and time must be later than the start date and time.

Once the programming is done, start recording by pressing the  key. If not enough memory is available, the device so indicates. The  icon of the status bar blinks to indicate that recording has begun. The  key replaces the  key and can be used to stop the recording before it is finished.

The *Recording on standby* message is displayed until the start time is reached. It is then replaced by the message *Recording running*. When the stop time is reached, the *Program a Record* screen returns with the  key. You can then program a new recording.

During the recording of a trend, only the stop date field can be modified. It is automatically highlighted in yellow.

### 9.2. TREND MODE CONFIGURATION

The  submenu displays the list of trend recording configurations (see §4.9). This shortcut key lets you specify or modify the trend recording configurations.

### 9.3. VIEWING THE RECORDING LIST

The  submenu displays the recording list already made.

Recording list memory usage. The black part of the bar corresponds to the fraction of memory used.

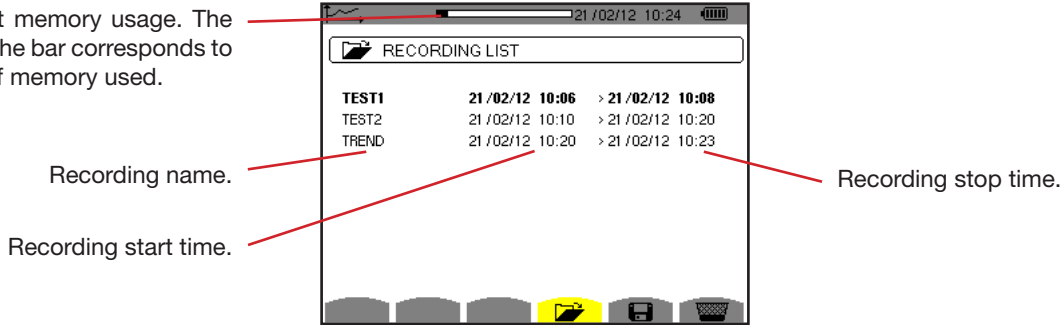

Recording name.

Recording start time.

Recording stop time.

Figure 89: Recording list display screen

If the stop date is in red, it means that it does not match the stop date initially programmed, because of a power supply problem (battery low or disconnection of the device supplied by mains only).

### 9.4. DELETING RECORDINGS

When the list of records is displayed (see figure 89), select the recording to be erased. This is done by moving the cursor to it using the ▲ and ▼ keys. The selected recording is bolded.

Then press the  key. Press ↵ to validate or ↶ to cancel.

### 9.5. VIEWING THE RECORDS

#### 9.5.1. CHARACTERISTICS OF THE RECORD

When the list of records is displayed (see figure 89), select the record to be displayed. This is done by moving the cursor to it using the ▲ and ▼ keys. The selected recording is bolded. Then press ↵ to validate.

Types of measurement chosen in the configuration used.

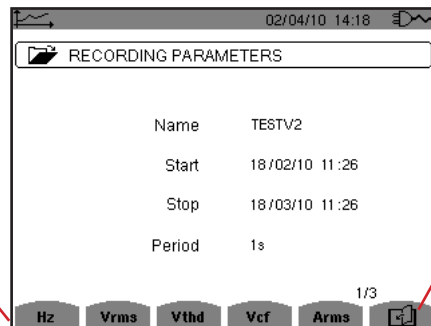

The  icon is used to navigate in the following screen pages. It is also possible to use the ◀ or ▶ key.

Figure 90: Recording list display screen

If a measurement does not appear in the tabs, it is because calculation of this measurement was incompatible with the configuration chosen (connection, types of sensors, ratios programmed).

For example, if the calculation mode chosen during the programming is Non-active Quantities not broken down (see §4.5.1), the D tab does not appear.

Press a yellow key to display the curve.



9.5.2. TREND CURVES

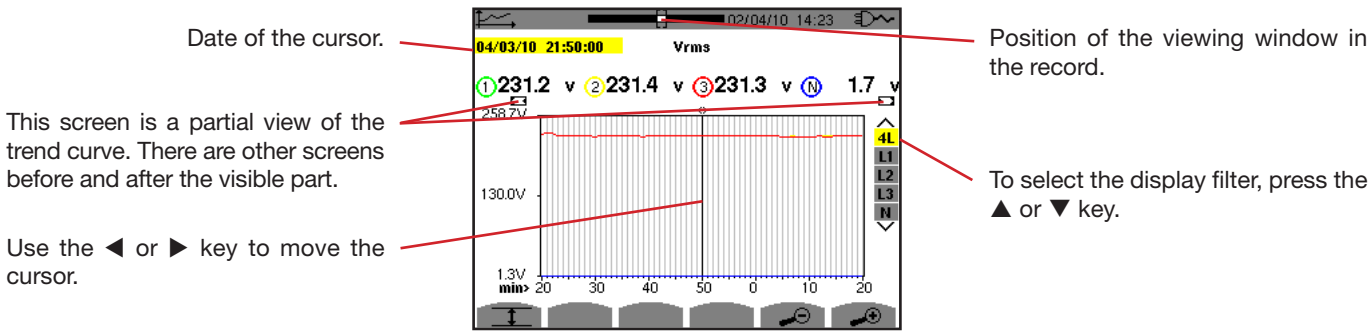

Figure 91: Vrms (4L) without MIN-AVG-MAX

The display period of this curve is one minute. Since the period of the record is one second, each point of this curve corresponds to a value recorded in a one-second window once a minute. There is therefore a substantial loss of information (59 values out of 60), but the display is rapid.

**Notes:** Values of the cursor in red indicate saturated values.

Black dashes - - - indicate erroneous values.

Red dashes - - - indicate values that are not calculated (following the end of calculation of the MIN-MAX-AVG mode when is pressed).

The MIN-AVG-MAX mode has been activated.

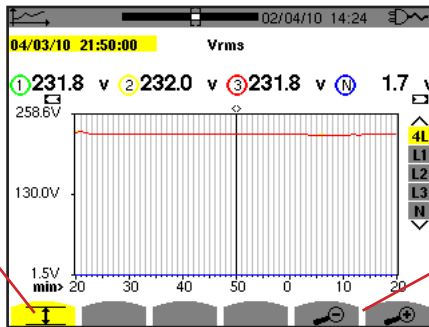

Figure 92: Vrms (4L) with MIN-AVG-MAX

The display period of this curve is one minute. But with the MIN-AVG-MAX mode activated, each point of this curve represents the arithmetic mean of 60 values recorded every second. This display is therefore more precise, because there is no loss of information, but slower (see the table of figure 108).

To stop the calculation of the MIN-AVG-MAX mode, press .

**Remarks:** While MIN-AVG-MAX mode is being calculated, a progress bar is displayed for this calculation in the status strip instead of the recording display window positioning bar.

The MIN-AVG-MAX mode is not available while a trend is being recorded.

To return to the *Characteristics of the Record* screen, press .

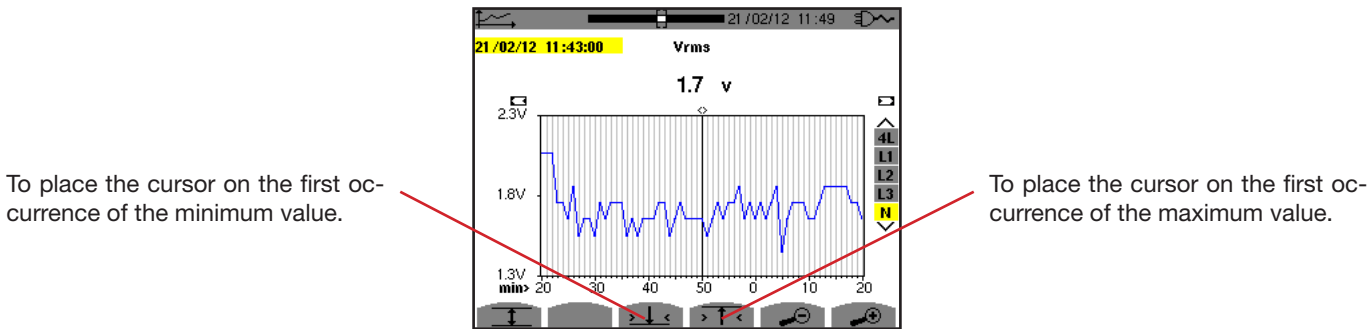
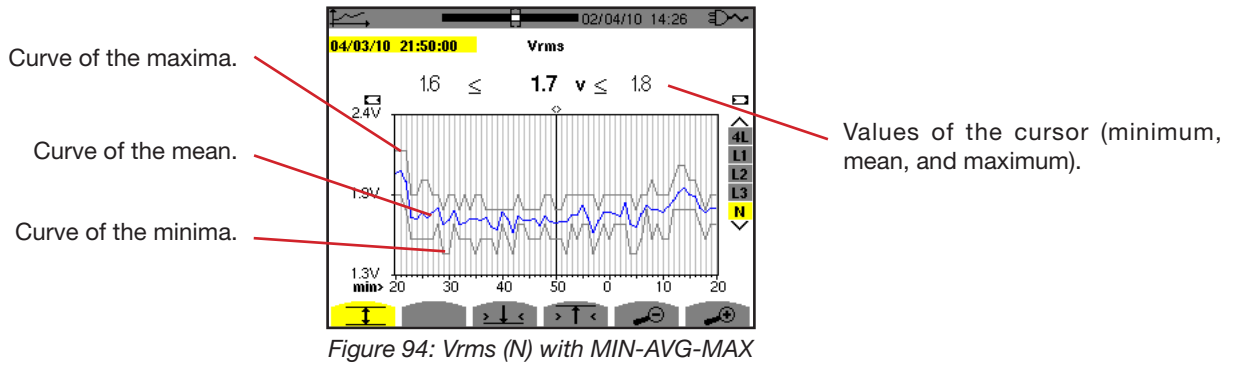

Figure 93: Vrms (N) without MIN-AVG-MAX

To place the cursor on the first occurrence of the minimum value.

To place the cursor on the first occurrence of the maximum value.

Pressing the or key automatically sets the zoom in to the highest level (display period identical to the recording period) and de-activates the MIN-AVG-MAX mode if it was activated.



The display period of this curve is one minute. Each point of the mean curve represents the arithmetic mean of 60 values recorded every second. Each point of the curve of the maxima represents the maximum of the 60 values recorded every second. Each point of the curve of the minima corresponds to the minimum of the 60 values recorded every second.

This display is therefore more precise than the previous one.

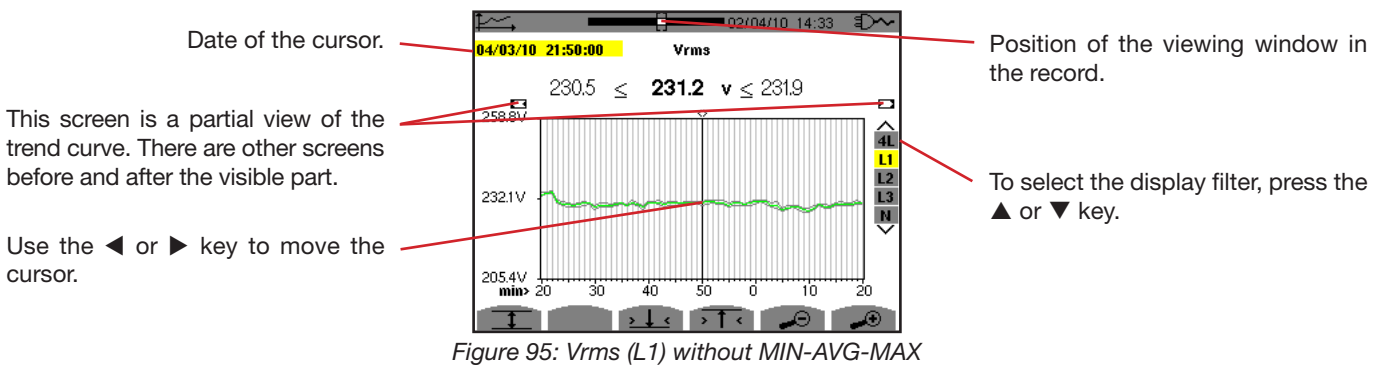

For each of the phases (L1, L2, and L3), at each recording of a value over one second (recording period), the device also records the minimum half-cycle RMS value over one second and the maximum half-cycle RMS value over one second. These are the three curves shown in the figure above.

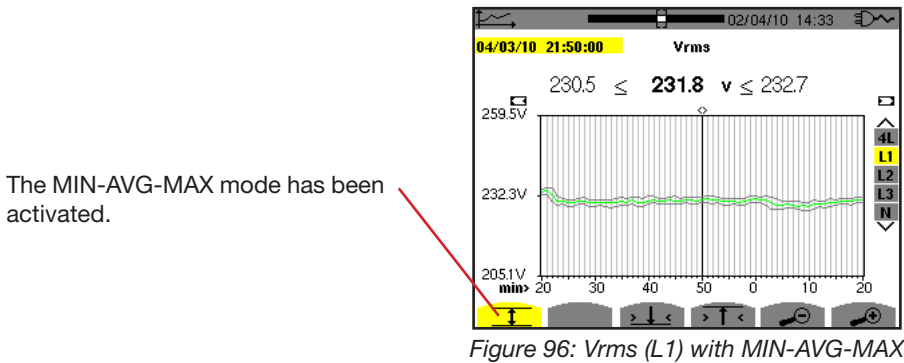

This curve differs slightly from the previous one because, with the MIN-AVG-MAX mode, there is no loss of information.

**Note:** For the quantities (P, Pdc, VAR, S, D, PF, cos  $\Phi$  and tan  $\Phi$ ) and for a three-phase source without neutral, only the total quantities are represented.

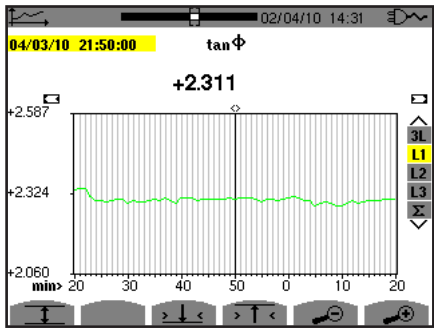

Figure 97: tan  $\Phi$  (L1) without MIN-AVG-MAX for a three-phase connection with neutral

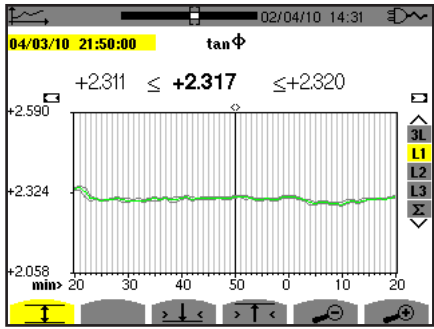
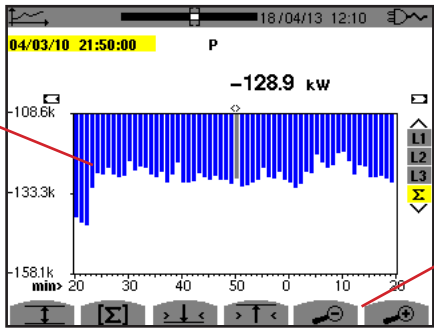

Figure 98: tan  $\Phi$  (L1) with MIN-AVG-MAX

The sum of the powers of the three phases ( $\Sigma$ ) is presented in bargraph form.



To change the scale of the display between 1 minute and 5 days.

Figure 99: P ( $\Sigma$ ) without MIN-AVG-MAX

For the energy curves, the quantities are expressed in Wh, J, toe, or BTU, depending on the unit chosen in the configuration of the device (see §4.5.2).

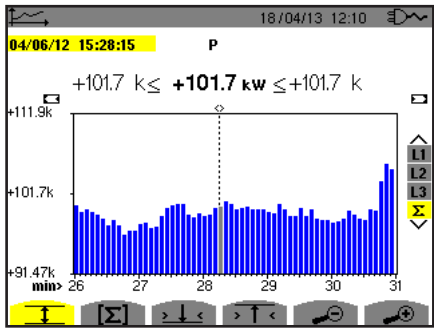

Figure 100: P ( $\Sigma$ ) with MIN-AVG-MAX

This curve differs slightly from the previous one because, with the MIN-AVG-MAX mode, there is no loss of information.

The MIN-AVG-MAX mode can be activated for the powers to display, above the curve, the mean power value at the cursor date along with the maximum and minimum power values in the display period. Note that, in contrast with the other quantities, only the bar chart of mean values is represented.

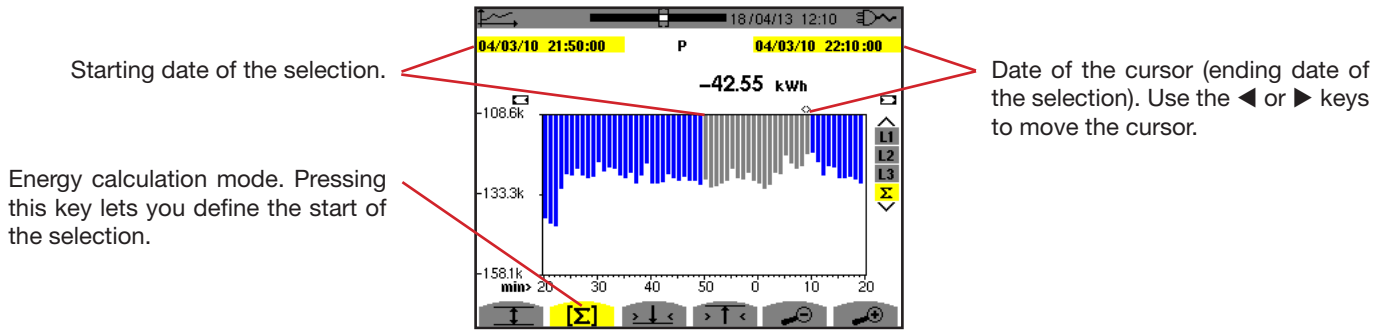

Figure 101:  $Ph (\Sigma)$  without MIN-AVG-MAX

The display period of this bar chart is one minute. Since the recording period is one second, each bar of this bar chart represents a value recorded in a one-second window once a minute.  
The energy calculation mode determines the sum of the powers on the selected bars.

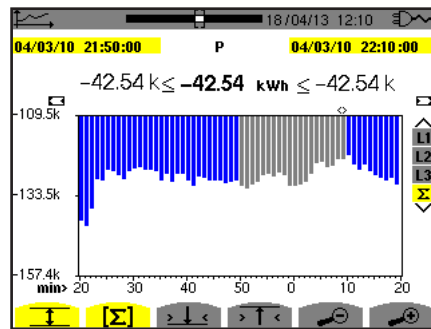

Figure 102:  $Ph (\Sigma)$  with MIN-AVG-MAX

With the MIN-AVG-MAX mode activated, the display differs slightly from the previous one because there is no loss of information.

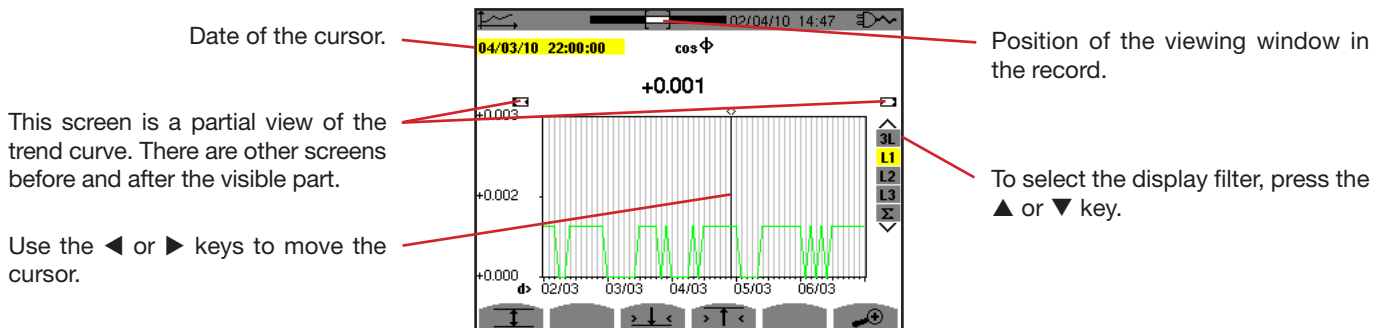

Figure 103:  $\cos \Phi (L1)$  without MIN-AVG-MAX

The period of display of this curve is two hours. Since the recording period is one second, each point of this curve represents a value recorded every second taken every two hours. There is therefore a substantial loss of information (7,199 out of 7,200), but the display is rapid.

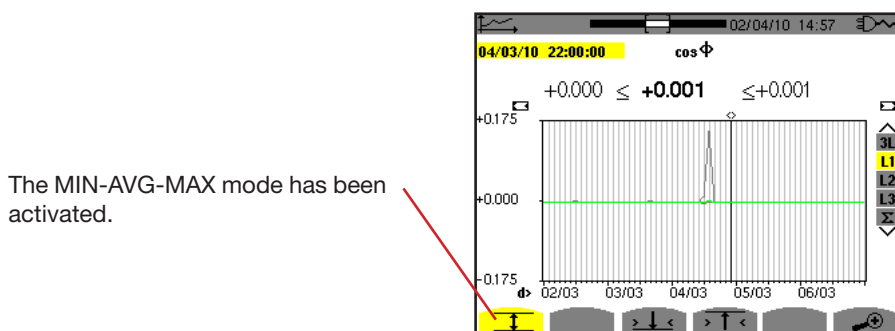

Figure 104:  $\cos \Phi (L1)$  with MIN-AVG-MAX

This curve differs considerably from the previous one, because the MIN-AVG-MAX mode is activated. Each point of the mean curve represents the arithmetic mean of 7,200 values recorded every second. Each point of the curve of the maxima represents the maximum of the 7,200 values recorded every second. Each point of the curve of the minima corresponds to the minimum of the 7,200 values recorded every second.

This display is therefore more precise, because there is no loss of information, but slower (see the table in figure 108).

The user can stop the loading of the recorded values and the calculation of the values displayed at any time by pressing this key.

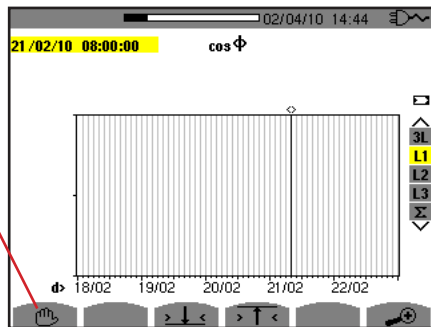
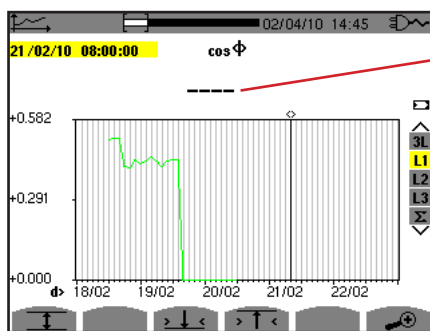

Figure 105:  $\cos \Phi$  (L1) loading/calculation of values.



The dashes indicate that the value is not available at the cursor position because it was not calculated.

Figure 106:  $\cos \Phi$  (L1) loading/calculation of values aborted.

Display of the record is not complete because construction was stopped before the end.

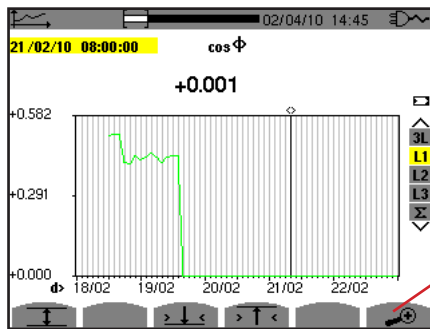

To change the scale of the display between 1 minute and 5 days.

Figure 107:  $\cos \Phi$  (L1) loading/calculation of complete values without MIN-AVG-MAX for a three-phase connection with neutral.

The display has not been stopped and is therefore complete.







The following table indicates the time needed to display the curve on screen as a function of the width of the display window for a recording period of one second:

Width of display window (60 points or increments)	Grid increment	Typical waiting time for display with the MIN-AVG-MAX mode deactivated	Typical waiting time for display with the MIN-AVG-MAX mode activated
5 days	2 hours	11 seconds	10 minutes
2,5 days	1 hour	6 seconds	5 minutes
15 hours	15 minutes	2 seconds	1 minute 15 seconds
10 hours	10 minutes	2 seconds	50 seconds
5 hours	5 minutes	1 second	25 seconds
1 hour	1 minute	1 second	8 seconds
20 minutes	10 seconds	1 second	2 seconds
5 minutes	5 seconds	1 second	1 second
1 minute	1 second	1 second	1 second

Figure 108: Display Times table

These times can be long, so it has been made possible to stop the display at any time by pressing the  key.

It is also possible, at any time:

- to press the  or  key to change the scale of the display,
- to press the  or  key to move the cursor,
- to press the  or  key to change the display filter.

But note that this may restart the loading and/or calculation of the values from the beginning.

# 10. POWER AND ENERGY MODE

The **W** key displays power- and energy-related measurements.

The sub-menus available depend on the filter.

- For 2- and 3-wire single-phase connections and for the 2-wire two-phase connection, only selection L1 is available. The filter is therefore not displayed, but the display is the same as for L1.
- For the 3-wire three-phase connection, only the  $\Sigma$  selection is available. The filter is therefore not displayed, but the display is the same as for  $\Sigma$ .

## 10.1. 3L FILTER

### 10.1.1. THE POWERS DISPLAY SCREEN

The **W...** sub-menu is used to display the powers.

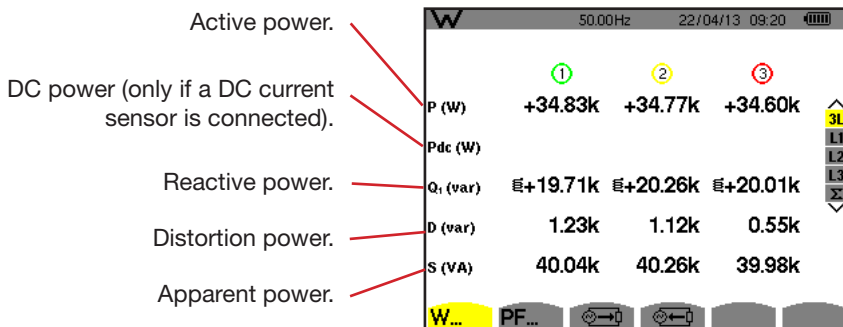

Figure 109: the 3L Powers screen.

**Note:** This screen corresponds to the choice “non-active quantities broken down” in the AR tab of the Calculation Methods menu of the Configuration mode. If the choice had been “non-active quantities not broken down”, then the D label (distortion power) would have disappeared and the Q<sub>1</sub> label would have been replaced by the N label. This non-active power is unsigned and has no inductive or capacitive effect.

### 10.1.2. THE QUANTITIES ASSOCIATED WITH THE POWERS DISPLAY SCREEN

The **PF** sub-menu... displays the quantities associated with the powers.



Figure 110: the Quantities Associated with the Powers screen in 3L

### 10.1.3. THE ENERGIES CONSUMED DISPLAY SCREEN

The sub-menu displays the meters of energy consumed by the load.

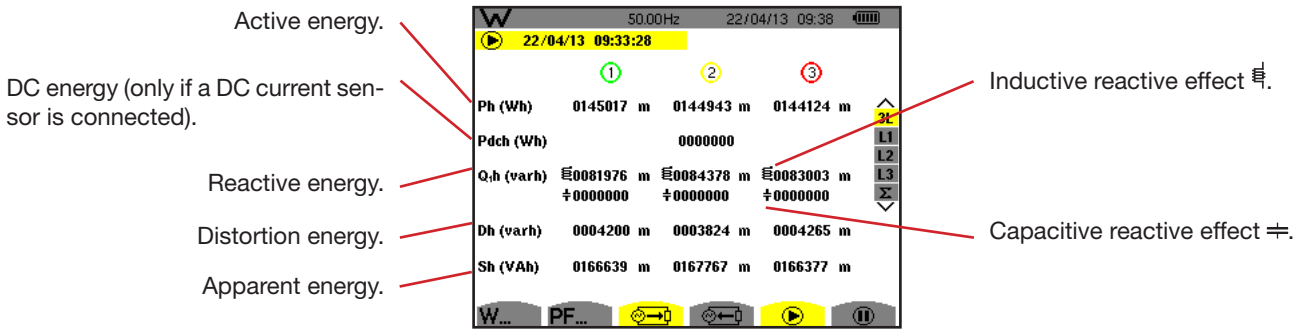

Figure 111: the Energies Consumed display screen in 3L

**Note:** This screen corresponds to the choice “non-active quantities broken down” in the VAR tab of the Calculation Methods menu of the Configuration mode. If the choice had been “non-active quantities not broken down”, then the Dh label (distortion energy) would have disappeared and the Q<sub>h</sub> label would have been replaced by the N<sub>h</sub> label. This non-active energy has no inductive or capacitive effect.

### 10.1.4. THE ENERGIES GENERATED DISPLAY SCREEN

The sub-menu displays the meters of the energy generated by the load.

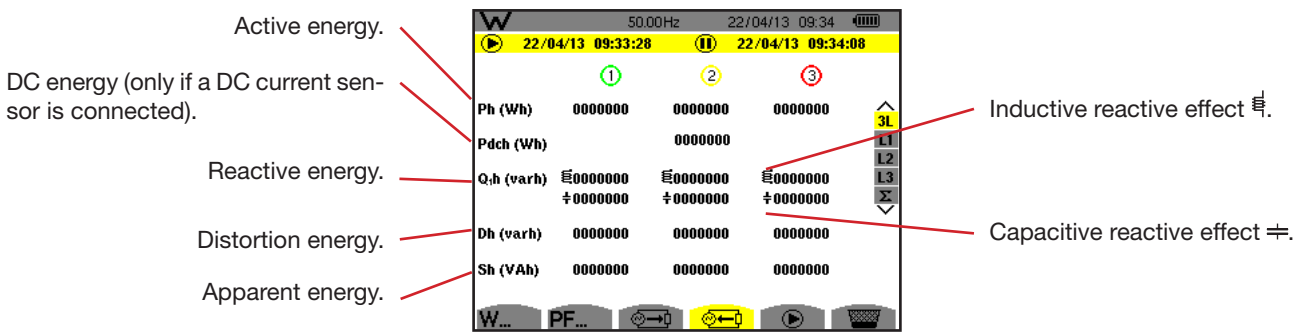

Figure 112: the Energies Generated display screen in 3L

**Note:** This screen corresponds to the choice “non-active quantities broken down” in the VAR tab of the Calculation Methods menu of the Configuration mode. If the choice had been “non-active quantities not broken down”, then the Dh label (distortion energy) would have disappeared and the Q<sub>h</sub> label would have been replaced by the N<sub>h</sub> label. This non-active energy has no inductive or capacitive effect.

## 10.2. FILTERS L1, L2 AND L3

### 10.2.1. THE POWERS AND ASSOCIATED QUANTITIES DISPLAY SCREEN

The **W...** sub-menu displays the powers and associated quantities.

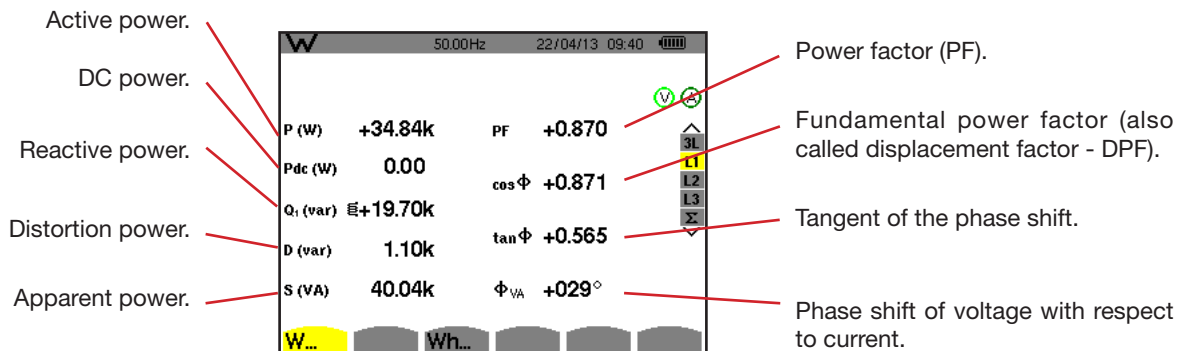

Figure 113: the Powers and Associated Quantities display screen in L1



**Notes:** This screen corresponds to the choice “non-active quantities broken down” in the VAR tab of the Calculation Methods menu of the Configuration mode. If the choice had been “non-active quantities not broken down”, then the D label (distortion power) would have disappeared and the  $Q_1$  label would have been replaced by the N label. This non-active power has no inductive or capacitive effect.

Filters L2 and L3 display the same information for phases 2 and 3.

$\Phi_{UA}$  is displayed for the 2-wire two-phase set-up.

### 10.2.2. THE ENERGY METERS DISPLAY SCREEN

The **Wh...** sub-menu displays the energy meters.

Meters of the energy consumed by the load.

Meters of the energy generated by the load.

Active energy.

DC energy (only if a DC current sensor is connected).

Reactive energy.

Distortion energy.

Apparent energy.

Inductive reactive effect  $\overset{\curvearrowright}{\neq}$ .

Capacitive reactive effect  $\overset{\curvearrowleft}{\neq}$ .

Phase	Active energy (Wh)	DC energy (Wh)	Reactive energy (varh)	Distortion energy (varh)	Apparent energy (VAh)
3L	0560872 m	0000000	0316958 m	0016885 m	0644468 m
L1	0000000	0000000	±0000000	±0000000	0000000
L2					
L3					
Σ					

Figure 114: the Energies Consumed and Generated display screen in L1

**Notes:** This screen corresponds to the choice «non-active quantities broken down» in the VAR tab of the Calculation Methods menu of the Configuration mode. If the choice had been «non-active quantities not broken down», then the Dh label (distortion energy) would have disappeared and the  $Q_1$  label would have been replaced by the Nh label. This non-active energy has no inductive or capacitive effect.

Filters L2 and L3 display the same information for phases 2 and 3.

## 10.3. FILTER $\Sigma$

### 10.3.1. THE TOTAL POWERS AND ASSOCIATED QUANTITIES DISPLAY SCREEN

The **W...** sub-menu displays the powers and associated quantities.

Total active power.

Total DC power.

Total reactive power.

Total distortion power.

Total apparent power.

Total power factor.

Total fundamental power factor (also called displacement factor - DPF).

Total tangent.

Parameter	Value
Total active power (P)	+104.2k
Total DC power (Pdc)	0.0
Total reactive power (Q1)	+60.0k
Total distortion power (D)	2.5k
Total apparent power (S)	120.3k
Total power factor (PF)	0.867
Total fundamental power factor (cos φ)	0.867
Total tangent (tan φ)	0.575

Figure 115: the Total Powers and Associated Quantities display screen in  $\Sigma$

**Note:** This screen corresponds to the choice “non-active quantities broken down” in the VAR tab of the Calculation Methods menu of the Configuration mode. If the choice had been “non-active quantities not broken down”, then the D label (distortion power) would have disappeared and the  $Q_1$  label would have been replaced by the N label. This non-active power has no inductive or capacitive effect.

### 10.3.2. THE TOTAL ENERGY METERS DISPLAY SCREEN

The **Wh...** sub-menu displays the energy meters.

Meters of energy consumed by the load.

Meters of the energy generated by the load.

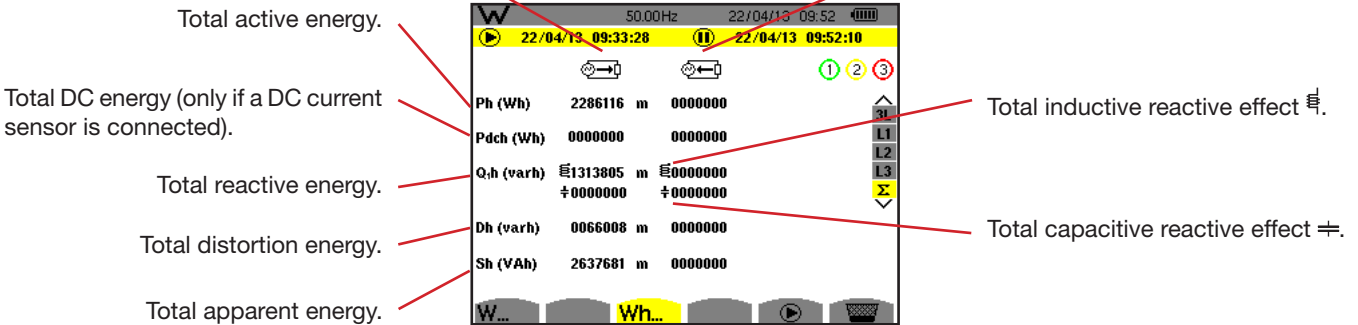

Figure 116: the Total Energies Consumed and Generated display screen in  $\Sigma$

**Notes:** This screen corresponds to the choice “non-active quantities broken down” in the VAR tab of the Calculation Methods menu of the Configuration mode. If the choice had been “non-active quantities not broken down”, then the Dh label (distortion energy) would have disappeared and the Q<sub>h</sub> label would have been replaced by the Nh label. This non-active energy has no inductive or capacitive effect.

For the 3-wire three-phase set-up, only the display of total quantities is available, the method of calculation of the powers used is the two-wattmeter method (with 2 sensors connected) or the three-wattmeter method with virtual neutral (with 3 sensors connected) (see Appendix, §16.1.4.3).

### 10.4. STARTING ENERGY METERING

To start an energy metering, press the key in an energies display screen (, , or **Wh...**).

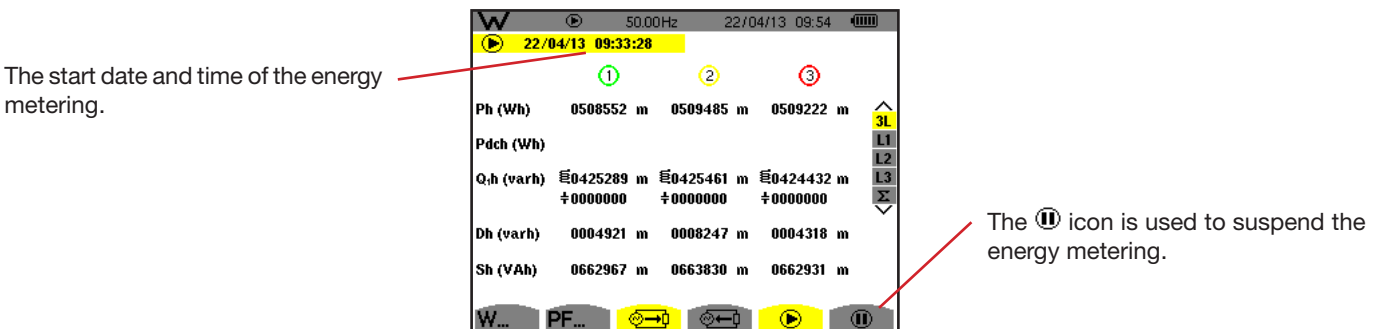

Figure 117: the Energy Metering Start-up screen in Wh

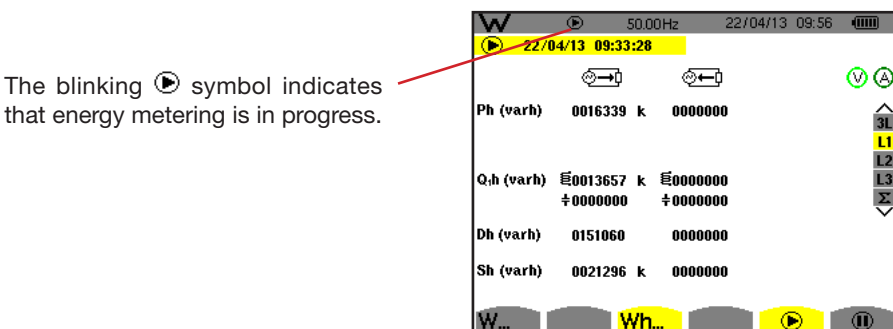

Figure 118: the Energy Metering screen in varh

The diagram used is the 4-quadrant diagram (see §16.5).

**Note:** The non-nullity threshold is 11.6 kWh for non-nuclear toe and 3.84 kWh for nuclear toe.

## 10.5. DISCONNECTION OF ENERGY METERING

To suspend energy metering, press **II**.

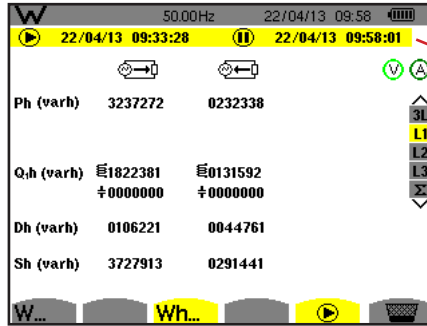

The stop date and time of the metering are displayed alongside the start date and time.

Figure 119: the Energy Metering screen in varh

A disconnection of the metering is not definitive. It can be resumed by pressing the **▶** key again.

**Note:** If no recording is in progress, then disconnecting the energy metering leads to the appearance of the blinking **▶** symbol in the status bar (in place of the **II** symbol). Disconnecting the energy metering also leads to the replacement of the **II** key by the **▶** key.

## 10.6. RESET OF ENERGY METERING

To suspend the metering, press the **II** key. Then, to reset energy metering, press the **▶** key and validate with the **↵** key. All energy values (consumed and generated) are then reset.









# 11. SCREEN SNAPSHOT MODE



The  key can be used to take up to 50 screen snapshots and display the recorded snapshots.

Saved screens may then be transferred to a PC using the PAT2 application (Power Analyser Transfer).

## 11.1. SCREEN SNAPSHOTS

Press the  key for approx. 3 seconds to shoot any screen .

When a screen snapshot is taken, the icon of the active mode (, , , , , , ) in the top strip of the display unit is replaced by the  icon. You can then release the  key .

The device can record only 50 screen snapshots. If you want to record a 51st screen, the device informs you that snapshots must be deleted by displaying the  icon in place of .

## 11.2. HANDLING OF SCREEN SNAPSHOTS

To enter screen snapshot mode, briefly press the  key. The device then displays a list of recorded screen snapshots.

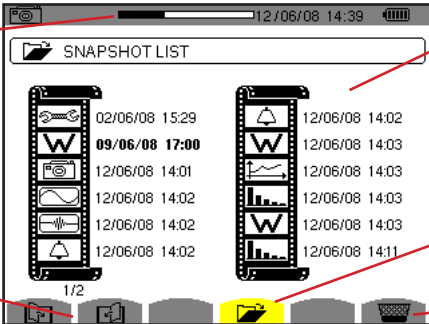

Indicator of available image memory. The black bar represents memory used and the white bar represents memory available.

List of saved snapshots. Each icon represents the type of screen recorded. It is followed by the date and time of the screen snapshot.





Icons for browsing in screen pages.





Display of the list of screen snapshots.

Deleting a screen snapshot.

Figure 120: the List of Screen Snapshots display screen





### 11.2.1. VIEWING A SNAPSHOT FROM THE LIST





To view a snapshot, select it in the list of screen snapshots using the , ,  and  keys. The date and time of the selected snapshot are bolded.

Press  to display the selected snapshot. The  icon is displayed in alternation with the icon for the mode that was active when the snapshot was taken (, , , , , , ) .

Press  to return to the list of screen snapshots.

### 11.2.2. DELETING A SNAPSHOT FROM THE LIST

To delete a snapshot, select it in the list of screen snapshots using the , ,  and  keys. The date and time of the selected snapshot are bolded.

Press the  key and validate by pressing . The snapshot then disappears from the list. To cancel the deletion, press  rather than .

## 12. HELP KEY

The **?** key provides information about the key functions and symbols used in the current display mode.

The following information is displayed:

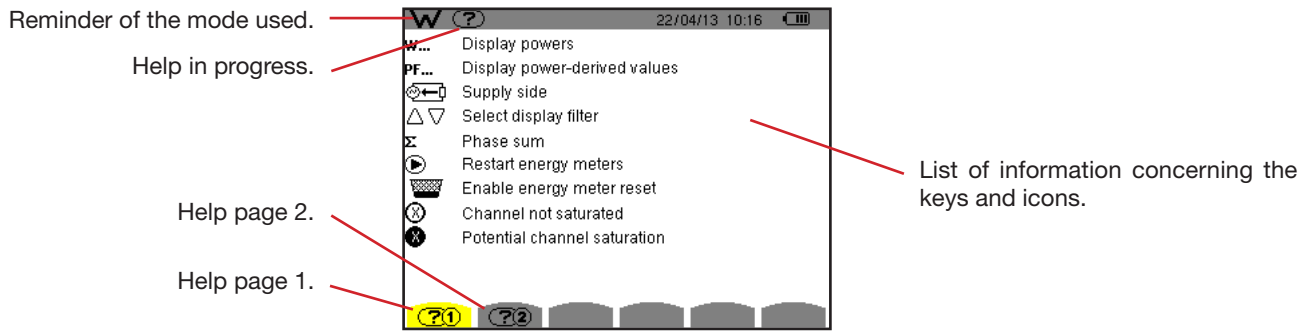

Figure 121: The help screen for the powers and energies mode, page 1

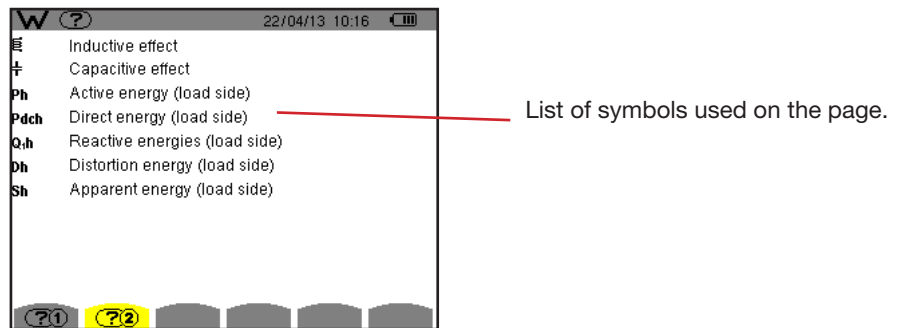
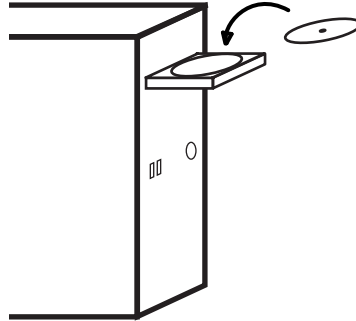

Figure 122: the screen of the help page for the powers and energies mode, page 2

## 13. DATA EXPORT SOFTWARE

The PAT2 (*Power Analyser Transfer 2*) data export software supplied with the device is used to transfer the data recorded in the device to a PC.

To install it, load the installation CD in the CD drive of your PC, then follow the instructions on screen.



Then connect the device to the PC using the USB cord supplied, after removing the cover that protects the USB port on the device.

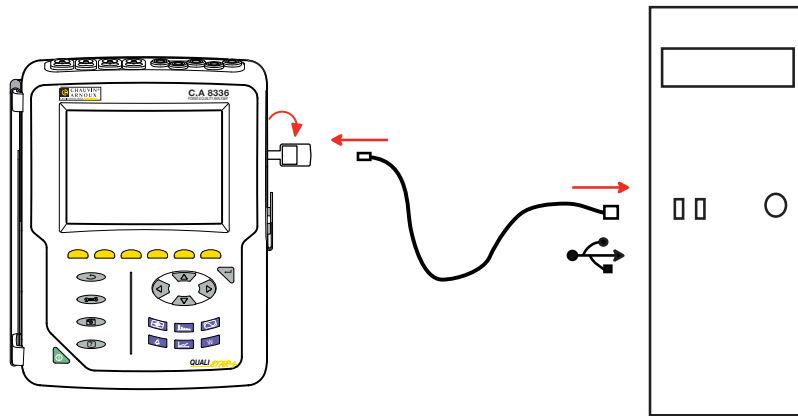

Switch the device on by pressing the  key and wait for your PC to detect it.

The PAT2 transfer software automatically defines the communication rate between the PC and the device.

**Note:** All measurements recorded in the device can be transferred to the PC via the USB link, using the PAT2 program. The transfer does not erase the recorded data unless the user explicitly asks it to.

The data stored in the memory card can also be read on a PC, using an SD card reader and the PAT2 program. For an explanation of how to withdraw the memory card, refer to §17.5.

For directions for using the data export software, use its Help function or refer to its user manual.

## 14. GENERAL SPECIFICATIONS

### 14.1. ENVIRONMENTAL CONDITIONS

The following chart shows conditions relating to ambient temperature and humidity:

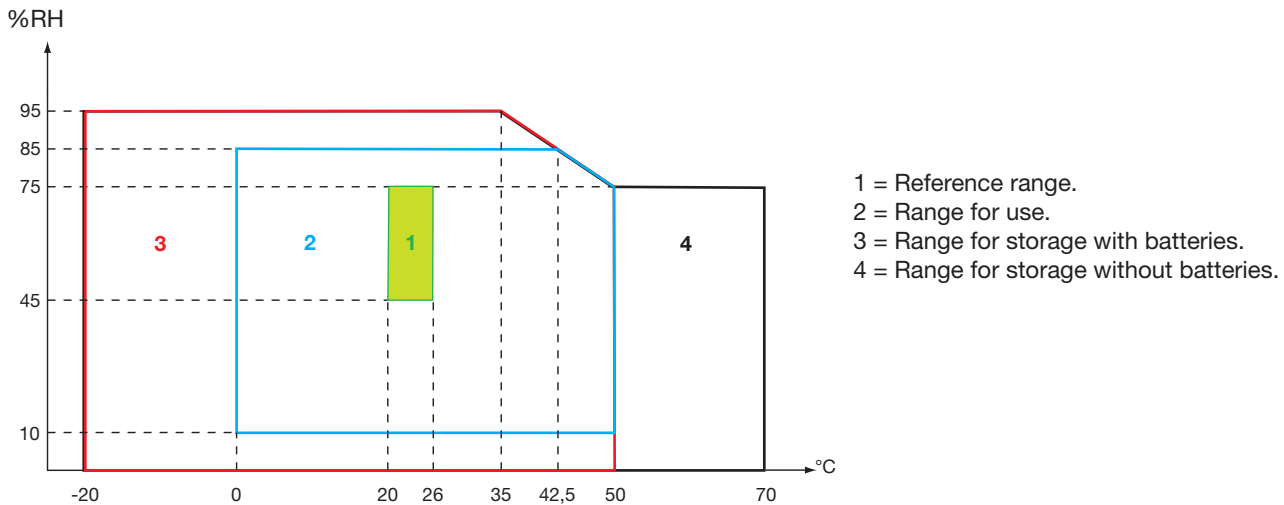

**Caution:** at temperatures above 40°C, the device must be powered by the battery alone **OR** by the mains power unit alone; use of the device with both the battery **AND** the mains power unit is **prohibited**.

#### Altitude :

Use < 2 000 m

Storage < 10 000 m

Degree of pollution : 2.

Use indoors.

### 14.2. MECHANICAL CONDITIONS

Dimensions (L x W x H) 200 mm x 250 mm x 70 mm  
Weight approximately 2 kg  
Screen 118 mm x 90 mm, diagonal 148 mm

#### Tightness

- IP53 per EN 60529 when the device is on its stand, with no lead connected, with the jack cover and the cap on the USB connector in the closed position
- IP20 at the level of the measurement terminals
- IK08 per EN 62262

Fall 1 m as per IEC 61010-1

### 14.3. OVERVOLTAGE CATEGORIES PER IEC 61010-1

The device is compliant with IEC 61010-1, 600 V category IV or 1000 V category III.

- the use of AmpFLEX™ or of MiniFLEX or C193 clamps keeps the “device + current sensor” system at 600 V category IV or 1000 V category III.
- the use of PAC93, J93, MN93, MN93A, or E3N clamps downgrades the “device + current sensor” system to 300 V category IV or 600 V category III.
- the use of the 5 A adapter unit downgrades the “device + current sensor” system to 150 V category IV or 300 V category III.

Double insulation between the inputs/outputs and earth.

Double insulation between the voltage inputs, the power supply, and the other inputs/outputs.

## 14.4. ELECTROMAGNETIC COMPATIBILITY

Emissions and immunity in an industrial setting compliant with IEC 61326-1.

As regards electromagnetic emissions, the device belongs to group 1, class A, under standard EN55011. Class A devices are intended for use in industrial environments. There may be difficulties ensuring electromagnetic compatibility in other environments, because of conducted and radiated disturbance.

As regards immunity to radio frequency fields, the device is equipment intended for use at industrial sites under standard IEC61326-1.

For the AmpFLEX™ and MiniFLEX sensors:

- An (absolute) influence of 2% may be observed on the current THD measurement in the presence of a radiated electric field.
- An influence of 0.5 A may be observed on the RMS current measurement in the presence of conducted radio frequencies.
- An influence of 1 A may be observed on the RMS current measurement in the presence of a magnetic field.

## 14.5. POWER SUPPLY

### 14.5.1. MAINS POWER SUPPLY

This is a specific 600 V<sub>RMS</sub>, category IV – 1000 V<sub>RMS</sub>, category III external mains power supply unit.

Range of use: 230 V ± 10 % @ 50 Hz and 120 V ± 10 % @ 60 Hz.

Maximum input power: 65 VA.

### 14.5.2. BATTERY POWER SUPPLY

The device is supplied by a 9.6 V, 4000 mAh battery pack, comprising 8 rechargeable NiMH elements.

Battery	8 NiMH storage cells.
Capacity	4000 mAh nominal.
Nominal voltage	1,2 V per cell, or a total of 9.6 V.
Life	at least 300 charge-discharge cycles.
Charging current	1 A.
Charging time	approx. 5 hours
Service T°	[0 °C ; 50 °C].
Charging T°	[10 °C ; 40 °C].
Storage T°	storage ≤ 30 days: [-20 °C ; 50 °C]. storage for 30 to 90 days: [-20 °C ; 40 °C]. storage for 90 days to 1 year: [-20 °C ; 30 °C].

If the device is to be left unused for an extended period, remove the battery (see § 17.3).

### 14.5.3. CONSUMPTION

Typical consumption of the device on mains (mA)	Battery being charged	Battery charged
Active power (W)	17	6
Apparent power (VA)	30	14
RMS current (mA)	130	60

### 14.5.4. BATTERY LIFE

Battery life is 10 hours when the battery delivered with the device is fully charged, with the display screen on. If the display screen is off (saving energy), battery life is more than 15 hours.



#### **14.5.5. DISPLAY UNIT**

The display unit is an active matrix (TFT) LCD type having the following characteristics:

- 5.7" diagonal
- resolution 320 x 240 pixels (1/4 VGA)
- colour
- minimum luminosity 210 cd/m<sup>2</sup>, typical 300 cd/m<sup>2</sup>
- response time between 10 and 25 ms
- angle of view 80° in all directions
- excellent rendering from 0 to 50°C

## 15. FUNCTIONAL CHARACTERISTICS

### 15.1. REFERENCE CONDITIONS

This table indicates the reference conditions of the quantities to be used by default in the characteristics indicated in § 15.3.4.

Parameter	Reference conditions
Ambient temperature	23 ± 3 °C
Humidity (relative humidity)	[45 %; 75 %]
Atmospheric pressure	[860 hPa ; 1060 hPa]
Phase-to-neutral voltage	[50 V <sub>RMS</sub> ; 1000 V <sub>RMS</sub> ] without DC (< 0.5 %)
Standard current circuit input voltage (Except <i>FLEX</i> type current sensors)	[30 mV <sub>RMS</sub> ; 1 V <sub>RMS</sub> ] without DC (< 0.5 %) <ul style="list-style-type: none"> <li>■ A<sub>nom</sub><sup>(1)</sup> ↔ 1 V<sub>RMS</sub></li> <li>■ 3 × A<sub>nom</sub><sup>(1)</sup> ÷ 100 ↔ 30 mV<sub>RMS</sub></li> </ul>
Unamplified Rogowski current circuit input voltage ( <i>FLEX</i> type current sensors)	[11.73 mV <sub>RMS</sub> ; 391 mV <sub>RMS</sub> ] without DC (< 0,5 %) <ul style="list-style-type: none"> <li>■ 10 kA<sub>RMS</sub> ↔ 391 mV<sub>RMS</sub> to 50 Hz</li> <li>■ 300 A<sub>RMS</sub> ↔ 11.73 mV<sub>RMS</sub> to 50 Hz</li> </ul>
Amplified Rogowski current circuit input voltage ( <i>FLEX</i> type current sensors)	[117.3 μV <sub>RMS</sub> ; 3.91 mV <sub>RMS</sub> ] without DC (< 0,5 %) <ul style="list-style-type: none"> <li>■ 100 A<sub>RMS</sub> ↔ 3.91 mV<sub>RMS</sub> to 50 Hz</li> <li>■ 3 A<sub>RMS</sub> ↔ 117.3 μV<sub>RMS</sub> to 50 Hz</li> </ul>
Frequency of electrical network	50 Hz ± 0,1 Hz or 60 Hz ± 0,1 Hz
Phase shift	0° (active power and energy) 90° (reactive power and energy)
Harmonics	< 0,1 %
Voltage unbalance	< 10 %
Voltage ratio	1 (unity)
Current ratio	1 (unity)
Voltages	measured (not calculated)
Current sensors	actual (not simulated)
Power supply	Battery only
Electric field	< 1 V.m <sup>-1</sup> for [80 MHz ; 1 GHz[ ≤ 0,3 V.m <sup>-1</sup> for [1 GHz ; 2 GHz[ ≤ 0,1 V.m <sup>-1</sup> for [2 GHz ; 2,7 GHz]
Magnetic field	< 40 A.m <sup>-1</sup> DC (earth's magnetic field)

(1) The values of A<sub>nom</sub> are given in the table below.

### 15.2. NOMINAL CURRENT ACCORDING TO TYPE OF SENSOR

Current sensor (except <i>FLEX</i> )	Nominal RMS current (A <sub>nom</sub> ) [A]	Lower limit of the reference range (3 × A <sub>nom</sub> ÷ 100) [A]
J93 clamp	3500	105
C193 clamp	1000	30
PAC93 clamp	1000	30
MN93 clamp	200	6
MN93A clamp (100 A)	100	3
E3N clamp (10 mV/A)	100	3
E3N clamp (100 mV/A)	10	0.3
MN93A clamp (5 A)	5	0.15
5 A adapter	5	0.15
Essailec® adapter	5	0.15

## 15.3. ELECTRICAL CHARACTERISTICS

### 15.3.1. VOLTAGE INPUT CHARACTERISTICS

Range for use:	0 V <sub>RMS</sub> to 1000 V <sub>RMS</sub> AC+DC phase-to-neutral and neutral-to-earth. 0 V <sub>RMS</sub> to 2000 V <sub>RMS</sub> AC+DC phase-to-phase. (on condition of compliance with 1000 V <sub>RMS</sub> with respect to earth in Cat III).
Input impedance:	1195 k $\Omega$ (between phase and neutral and between neutral and earth).
Admissible overload:	1200 V <sub>RMS</sub> constant. 2000 V <sub>RMS</sub> for one second.

### 15.3.2. CURRENT INPUT CHARACTERISTICS

Operating range:	[0 V ; 1 V]
Input impedance:	1 M $\Omega$ .
Admissible overload:	1.7 V <sub>RMS</sub> constant.

*FLEX* type current sensors (Amp*FLEX*<sup>™</sup> and Mini*FLEX*) switch the current input to an integrator assembly (amplified or unamplified Rogowski channel) capable of interpreting the signals from Rogowski sensors. The input impedance is reduced to 12.4 k $\Omega$  in this case.

### 15.3.3. BANDWIDTH

Measurement channels: 256 points per period, i.e.:

- At 50 Hz: 6.4 kHz ( $256 \times 50 \div 2$ ).
- At 60 Hz: 7.68 kHz ( $256 \times 60 \div 2$ ).

The analogue 3-dB bandwidth: 76 kHz.

### 15.3.4. CHARACTERISTICS OF THE DEVICE ALONE (EXCLUDING THE CURRENT SENSOR)

## Quantities concerning currents and voltages

Measurement		Measurement range without ratio (with unity ratio)		Display resolution (with unity ratio)	Maximum intrinsic error
		Minimum	Maximum		
Frequency		40 Hz	70 Hz	10 mHz	±10 mHz
RMS voltage <sup>(5)</sup>	simple	2 V	1,000 V <sup>(1)</sup>	100 mV V < 1000 V	±(0.5 % + 200 mV)
				1 V V ≥ 1000 V	±(0.5 % + 1 V)
	compound	2 V	2,000 V <sup>(2)</sup>	100 mV U < 1000 V	±(0.5 % + 200 mV)
				1 V U ≥ 1000 V	±(0.5 % + 1 V)
Direct voltage (DC) <sup>(6)</sup>	simple	2 V	1,200 V <sup>(3)</sup>	100 mV V < 1000 V	±(1 % + 500 mV)
				1 V V ≥ 1000 V	±(1 % + 1 V)
	compound	2 V	2,400 V <sup>(3)</sup>	100 mV U < 1000 V	±(1 % + 500 mV)
				1 V U ≥ 1000 V	±(1 % + 1 V)
RMS ½ voltage	simple	2 V	1,000 V <sup>(1)</sup>	100 mV V < 1000 V	±(0.8 % + 1 V)
				1 V V ≥ 1000 V	
	compound	2 V	2,000 V <sup>(2)</sup>	100 mV U < 1000 V	±(0.8 % + 1 V)
				1 V U ≥ 1000 V	
Peak voltage	simple	2 V	1,414 V <sup>(4)</sup>	100 mV V < 1000 V	±(3 % + 2 V)
				1 V V ≥ 1000 V	
	compound	2 V	2,828 V <sup>(4)</sup>	100 mV U < 1000 V	±(3 % + 2 V)
				1 V U ≥ 1000 V	
Severity of short-term flicker (PST)		0	12	0.01	See the corresponding table
Severity of long-term flicker (PLT)		0	12	0.01	Uncertainty of PST
Peak factor (PF) (voltage and current)		1	9.99	0.01	±(1 % + 5 ct) CF < 4
					±(5 % + 2 ct) CF ≥ 4

(1) In 1,000 V<sub>RMS</sub>, category III, provided that the voltage between each of the terminals and earth does not exceed 1,000 V<sub>RMS</sub>.

(2) Two-phase (opposite phases) – same note as (1).

(3) Limitation of the voltage inputs.

(4)  $1000 \times \sqrt{2} \approx 1414$ ;  $2000 \times \sqrt{2} \approx 2828$ ;

(5) Total RMS value and RMS value of the fundamental

(6) DC harmonic component (n= 0)

Measurement		Measurement range without ratio (with unity ratio)		Display resolution (with unity ratio)	Maximum intrinsic error
		Minimum	Maximum		
RMS current <sup>(2)</sup>	J93 clamp	3 A	3,500 A	1 A	±(0.5 % + 1 A)
	C193 clamp PAC93 clamp	1 A	1,000 A	100 mA A < 1000 A	±(0.5 % + 200 mA)
				1 A A ≥ 1000 A	±(0.5 % + 1 A)
	MN93 clamp	200 mA	200 A	100 mA	±(0.5 % + 200 mA)
	E3N clamp (10 mV/A) MN93A clamp (100 A)	100 mA	100 A	10 mA A < 100 A	±(0.5 % + 20 mA)
				100 mA A ≥ 100 A	±(0.5 % + 100 mA)
	E3N clamp (100 mV/A)	10 mA	10 A	1 mA A < 10 A	±(0.5 % + 2 mA)
				10 mA A ≥ 10 A	±(0.5 % + 10 mA)
	MN93A clamp (5 A) 5 A adapter Essailec <sup>®</sup> adapter	5 mA	5 A	1 mA	±(0.5 % + 2 mA)
	AmpFLEX <sup>™</sup> A193 MiniFLEX MA193 (10 kA)	10 A	10 kA	1 A A < 10 kA	±(0.5 % + 3 A)
10 A A ≥ 10 kA					
AmpFLEX <sup>™</sup> A193 MiniFLEX MA193 (6500 A)	10 A	6,500 A	100 mA A < 1000 A	±(0.5 % + 3 A)	
			1 A A ≥ 1000 A		
AmpFLEX <sup>™</sup> A193 MiniFLEX MA193 (100 A)	100 mA	100 A	10 mA A < 100 A	±(0.5 % + 30 mA)	
			100 mA A ≥ 100 A		
Direct current (DC) <sup>(3)</sup>	J93 clamp	3 A	5,000 A	1A	±(1 % + 1 A)
	PAC93 clamp	1 A	1,300 A <sup>(1)</sup>	100 mA A < 1000 A	±(1 % + 1 A)
				1 A A ≥ 1000 A	
	E3N clamp (10 mV/A)	100 mA	100 A <sup>(1)</sup>	10 mA A < 100 A	±(1 % + 100 mA)
				100 mA A ≥ 100 A	
E3N clamp (100 mV/A)	10 mA	10 A <sup>(1)</sup>	1 mA A < 10 A	±(1 % + 10 mA)	
			10 mA A ≥ 10 A		

(1) Limitation of the PAC93 and E3N clamps

(2) Total RMS value and RMS value of the fundamental

(3) DC harmonic component (n= 0)

Measurement		Measurement range without ratio (with unity ratio)		Display resolution (with unity ratio)	Maximum intrinsic error
		Minimum	Maximum		
RMS ½ current	J93 clamp	1 A	3,500 A	1 A	± (1 % + 1 A)
	C193 clamp PAC93 clamp	1 A	1,200 A	100 mA A < 1,000 A	±(1 % + 1 A)
				1 A A ≥ 1,000 A	
	MN93 clamp	200 mA	240 A	100 mA	±(1 % + 1 A)
	E3N clamp (10 mV/A) MN93A clamp (100 A)	0.1A	120 A	10 mA A < 100 A	±(1 % + 100 mA)
				100 mA A ≥ 100 A	
	E3N clamp (100 mV/A)	10 mA	12 A	1 mA A < 10 A	±(1 % + 10 mA)
				10 mA A ≥ 10 A	
	MN93A clamp (5 A) 5 A adapter Essailec® adapter	5 mA	6 A	1 mA	±(1 % + 10 mA)
AmpFLEX™ A193 MiniFLEX MA193 (10 kA)	10 A	10 kA	1 A A < 10 kA	±(2.5 % + 5 A)	
			10 A A ≥ 10 kA		
AmpFLEX™ A193 MiniFLEX MA193 (6500 A)	10 A	6,500 A	100 mA A < 1000 A	±(2.5 % + 5 A)	
			1 A A ≥ 1000 A		
AmpFLEX™ A193 MiniFLEX MA193 (100 A)	100 mA	100 A	10 mA A < 100 A	±(2.5 % + 200 mA)	
			100 mA A ≥ 100 A		
Peak current (PK)	J93 clamp	1 A	4,950 A <sup>(1)</sup>	1 A	±(1 % + 2 A)
	C193 clamp PAC93 clamp	1 A	1,414 A <sup>(1)</sup>	1 A A < 1,000 A	±(1 % + 2 A)
				1 A A ≥ 1,000 A	
	MN93 clamp	200 mA	282.8 A <sup>(1)</sup>	100 mA	±(1 % + 2 A)
	E3N clamp (10 mV/A) MN93A clamp (100 A)	100 mA	141.4 A <sup>(1)</sup>	10 mA A < 100 A	±(1 % + 200 mA)
				100 mA A ≥ 100 A	
	E3N clamp (100 mV/A)	10 mA	14.14 A <sup>(1)</sup>	1 mA A < 10 A	±(1 % + 20 mA)
				10 mA A ≥ 10 A	
	MN93A clamp (5 A) 5 A adapter Essailec® adapter	5 mA	7.071 A <sup>(1)</sup>	1 mA	±(1 % + 20 mA)
AmpFLEX™ A193 MiniFLEX MA193 (10 kA)	10 A	14.14 kA <sup>(1)</sup>	1 A A < 10 kA	±(3 % + 5 A)	
			10 A A ≥ 10 kA		
AmpFLEX™ A193 MiniFLEX MA193 (6500 A)	10 A	9,192 kA <sup>(1)</sup>	100 mA A < 1,000 A	±(3 % + 5 A)	
			1 A A ≥ 1,000 A		
AmpFLEX™ A193 MiniFLEX MA193 (100 A)	100 mA	141.4 A <sup>(1)</sup>	10 mA A < 100 A	±(3 % + 600 mA)	
			100 mA A ≥ 100 A		

(1)  $3,500 \times \sqrt{2} \approx 4,950$ ;  $1000 \times \sqrt{2} \approx 1,414$ ;  $200 \times \sqrt{2} \approx 282.8$ ;  $100 \times \sqrt{2} \approx 141.4$ ;  $10 \times \sqrt{2} \approx 14.14$ ;  $10,000 \times \sqrt{2} \approx 14,140$ ;  
 $6,500 \times \sqrt{2} \approx 9192$ ;

## Quantities concerning powers and energies

Measurement		Measurement range without ratio (with unity ratio)		Display resolution (with unity ratio)	Maximum intrinsic error
		Minimum	Maximum		
Active power (P) <sup>(1)</sup>	Excluding <i>FLEX</i>	10 mW <sup>(3)</sup>	10 MW <sup>(4)</sup>	4 digits at most <sup>(5)</sup>	$\pm(1\%)$ $\cos \Phi \geq 0.8$
					$\pm(1.5\% + 10 \text{ ct})$ $0.2 \leq \cos \Phi < 0.8$
	AmpFLEX™ MiniFLEX				$\pm(1\%)$ $\cos \Phi \geq 0.8$
					$\pm(1.5\% + 10 \text{ ct})$ $0.5 \leq \cos \Phi < 0.8$
Reactive power (Q <sub>r</sub> ) <sup>(2)</sup> and non-active (N)	Excluding <i>FLEX</i>	10 mvar <sup>(3)</sup>	10 Mvar <sup>(4)</sup>	4 digits at most <sup>(5)</sup>	$\pm(1\%)$ $\sin \Phi \geq 0.5$
					$\pm(1.5\% + 10 \text{ ct})$ $0.2 \leq \sin \Phi < 0.5$
	AmpFLEX™ MiniFLEX				$\pm(1.5\%)$ $\sin \Phi \geq 0.5$
					$\pm(2.5\% + 20 \text{ ct})$ $0.2 \leq \sin \Phi < 0.5$
Distortion power (D) <sup>(7)</sup>		10 mvar <sup>(3)</sup>	10 Mvar <sup>(4)</sup>	4 digits at most <sup>(5)</sup>	$\pm(4\% + 20 \text{ ct})$ if $\forall n \geq 1, \tau_n \leq (100 \div n) [\%]$
					or
					$\pm(2\% + (n_{\max} \times 0.5\%) + 100 \text{ ct})$ $\text{THD}_A \leq 20\% f$
					$\pm(2\% + (n_{\max} \times 0.7\%) + 10 \text{ ct})$ $\text{THD}_A > 20\% f$
Apparent power (S)		10 mVA <sup>(3)</sup>	10 MVA <sup>(4)</sup>	4 digits at most <sup>(5)</sup>	$\pm(1\%)$
DC power (P <sub>dc</sub> )		20 mVA <sup>(8)</sup>	6 MVA <sup>(9)</sup>	4 digits at most <sup>(5)</sup>	
Peak factor (PF)		-1	1	0.001	$\pm(1.5\%)$ $\cos \Phi \geq 0.5$
					$\pm(1.5\% + 10 \text{ ct})$ $0.2 \leq \cos \Phi < 0.5$
Active energy (Ph) <sup>(1)</sup>	Excluding <i>FLEX</i>	1 mWh	9,999,999 MWh <sup>(6)</sup>	7 digits at most <sup>(5)</sup>	$\pm(1\%)$ $\cos \Phi \geq 0.8$
					$\pm(1.5\%)$ $0.2 \leq \cos \Phi < 0.8$
	AmpFLEX™ MiniFLEX				$\pm(1\%)$ $\cos \Phi \geq 0.8$
					$\pm(1.5\%)$ $0.5 \leq \cos \Phi < 0.8$
Reactive energy (Q <sub>r</sub> ) <sup>(2)</sup> and non-active energy (N) <sup>(2)</sup>	Excluding <i>FLEX</i>	1 mvarh	9,999,999 Mvarh <sup>(6)</sup>	7 digits at most <sup>(5)</sup>	$\pm(1\%)$ $\sin \Phi \geq 0.5$
					$\pm(1.5\%)$ $0.2 \leq \sin \Phi < 0.5$
	AmpFLEX™ MiniFLEX				$\pm(1.5\%)$ $\sin \Phi \geq 0.5$
					$\pm(2.5\%)$ $0.2 \leq \sin \Phi < 0.5$
Distortion energy (D <sub>h</sub> )		1 mvarh	9,999,999 Mvarh <sup>(6)</sup>	7 digits at most <sup>(5)</sup>	$\pm(5.5\%)$ $\text{THD}_A \leq 20\% f$
					$\pm(1.5\%)$ $\text{THD}_A > 20\% f$
Apparent energy (Sh)		1 mVAh	9,999,999 MVAh <sup>(6)</sup>	7 digits at most <sup>(5)</sup>	$\pm(1\%)$
DC energy (P <sub>dch</sub> )		1 mWh	9,999,999 MWh <sup>(10)</sup>	7 digits at most <sup>(5)</sup>	

(1) The stated uncertainties on the active power and energy measurements are maxima for  $|\cos \Phi| = 1$  and typical for the other phase differences.

(2) The stated uncertainties on the reactive power and energy measurements are maxima for  $|\sin \Phi| = 1$  and typical for the other phase shifts.

(3) With MN93A clamp (5 A) or 5 A adapter or Essailec® adapter.

(4) With AmpFLEX™ or MiniFLEX for a 2-wire single-phase connection (phase-to-ground voltage).

(5) The resolution depends on the current sensor used and on the value to be displayed.

(6) The energy is equivalent to more than 114 years of the associated maximum power (unity ratios).

- (7)  $n_{max}$  is the highest order for which the harmonic ratio is non-zero.
- (8) With E3N clamp (100 mV/A)
- (9) With J93 clamp, for a 2-wire single-phase connection (phase-to-ground voltage).
- (10) The energy corresponds to more than 190 years at maximum power Pdc (unit ratios).

**Quantities associated with power**

Measurement	Measurement range		Display resolution	Maximum intrinsic error
	Minimum	Maximum		
Phase differences of fundamentals	-179°	180°	1°	±2°
cos Φ (DPF)	-1	1	0.001	±1° for Φ ±5 ct for cos Φ
tan Φ	-32.77 <sup>(1)</sup>	32.77 <sup>(1)</sup>	0.001 tan Φ < 10	±1° for Φ
			0.01 tan Φ ≥ 10	
Voltage unbalance (UNB)	0 %	100 %	0.1 %	±3 ct UNB ≤ 10%
				±10 ct UNB > 10%
Current unbalance (UNB)	0 %	100 %	0.1 %	±10 ct

(1)  $|\tan \Phi| = 32,767$  corresponds to  $\Phi = \pm 88.25^\circ + k \times 180^\circ$  (k being a natural number)



**Quantities concerning the spectral composition of the signals**

Measurement	Measurement range		Display resolution	Maximum intrinsic error
	Minimum	Maximum		
Voltage harmonic ratio ( $\tau_n$ )	0 %	1500 %f 100 %r	0.1 % $\tau_n < 1000$ % 1 % $\tau_n \geq 1000$ %	$\pm(2.5 \% + 5 \text{ ct})$
Current harmonic ratio ( $\tau_n$ ) (non-FLEX)	0 %	1500 %f 100 %r	0.1 % $\tau_n < 1000$ % 1 % $\tau_n \geq 1000$ %	$\pm(2 \% + (n \times 0.2 \%) + 10 \text{ ct})$ $n \leq 25$ $\pm(2 \% + (n \times 0.6 \%) + 5 \text{ ct})$ $n > 25$
Current harmonic ratio ( $\tau_n$ ) (AmpFLEX™ & MiniFLEX)	0 %	1500 %f 100 %r	0.1 % $\tau_n < 1000$ % 1 % $\tau_n \geq 1000$ %	$\pm(2 \% + (n \times 0.3 \%) + 5 \text{ ct})$ $n \leq 25$ $\pm(2 \% + (n \times 0.6 \%) + 5 \text{ ct})$ $n > 25$
Total voltage harmonic distortion (THD) (referred to the fundamental) of voltage	0 %	999.9 %	0.1 %	$\pm(2.5 \% + 5 \text{ ct})$
Total current harmonic distortion (THD) (referred to the fundamental) of current (non-FLEX)	0 %	999.9 %	0.1 %	$\pm(2.5 \% + 5 \text{ ct})$ if $\forall n \geq 1. \tau_n \leq (100 \div n)$ [%] or $\pm(2 \% + (n_{\max} \times 0.2 \%) + 5 \text{ ct})$ $n_{\max} \leq 25$ $\pm(2 \% + (n_{\max} \times 0.5 \%) + 5 \text{ ct})$ $n_{\max} > 25$
Total current harmonic distortion (THD) (referred to the fundamental) of current (AmpFLEX™ & MiniFLEX)	0 %	999.9 %	0.1 %	$\pm(2.5 \% + 5 \text{ ct})$ if $\forall n \geq 1. \tau_n \leq (100 \div n^2)$ [%] or $\pm(2 \% + (n_{\max} \times 0.3 \%) + 5 \text{ ct})$ $n_{\max} \leq 25$ $\pm(2 \% + (n_{\max} \times 0.6 \%) + 5 \text{ ct})$ $n_{\max} > 25$
Total voltage harmonic distortion (THD) (referred to the signal without DC) of voltage	0 %	100 %	0.1 %	$\pm(2.5 \% + 5 \text{ ct})$
Total current harmonic distortion (THD) (referred to the signal without DC) of current (non-FLEX)	0 %	100 %	0.1 %	$\pm(2.5 \% + 5 \text{ ct})$ if $\forall n \geq 1. \tau_n \leq (100 \div n)$ [%] or $\pm(2 \% + (n_{\max} \times 0.2 \%) + 5 \text{ ct})$ $n_{\max} \leq 25$ $\pm(2 \% + (n_{\max} \times 0.5 \%) + 5 \text{ ct})$ $n_{\max} > 25$
Total current harmonic distortion (THD) (referred to the signal without DC) of current (AmpFLEX™ & MiniFLEX)	0 %	100 %	0.1 %	$\pm(2.5 \% + 5 \text{ ct})$ if $\forall n \geq 1. \tau_n \leq (100 \div n^2)$ [%] or $\pm(2 \% + (n_{\max} \times 0.3 \%) + 5 \text{ ct})$ $n_{\max} \leq 25$ $\pm(2 \% + (n_{\max} \times 0.6 \%) + 5 \text{ ct})$ $n_{\max} > 25$
Harmonic loss factor (FHL)	1	99.99	0.01	$\pm(5 \% + (n_{\max} \times 0.4 \%) + 5 \text{ ct})$ $n_{\max} \leq 25$ $\pm(10 \% + (n_{\max} \times 0.7 \%) + 5 \text{ ct})$ $n_{\max} > 25$
K factor (FK)	1	99.99	0.01	$\pm(5 \% + (n_{\max} \times 0.4 \%) + 5 \text{ ct})$ $n_{\max} \leq 25$ $\pm(10 \% + (n_{\max} \times 0.7 \%) + 5 \text{ ct})$ $n_{\max} > 25$
Phase shifts of harmonics (order $\geq 2$ )	-179°	180°	1°	$\pm(1.5^\circ + 1^\circ \times (n \div 12.5))$

**Note :**  $n_{\max}$  is the highest order for which the harmonic ratio is non-zero.

Measurement		Measurement range (with unity ratio)		Display resolution (with unity ratio)	Maximum intrinsic error
		Minimum	Maximum		
RMS harmonic voltage (order $n \geq 2$ )	simple	2 V	1000 V <sup>(1)</sup>	100 mV $V < 1000$ V	$\pm(2.5 \% + 1 \text{ V})$
				1 V $V \geq 1000$ V	
	compound	2 V	2000 V <sup>(2)</sup>	100 mV $U < 1000$ V	$\pm(2.5 \% + 1 \text{ V})$
				1 V $U \geq 1000$ V	
RMS distortion voltage	simple (Vd)	2 V	1000 V <sup>(1)</sup>	100 mV $V < 1000$ V	$\pm(2.5 \% + 1 \text{ V})$
				1 V $V \geq 1000$ V	
	compound (Ud)	2 V	2000 V <sup>(2)</sup>	100 mV $U < 1000$ V	$\pm(2.5 \% + 1 \text{ V})$
				1 V $U \geq 1000$ V	
RMS harmonic current (order $n \geq 2$ )	J93 clamp	1 A	3500 A	1 A	$\pm(2 \% + (n \times 0.2\%) + 1 \text{ A})$ $n \leq 25$
	C193 clamp PAC93 clamp	1 A	1000 A	100 mA $A < 1000$ A	$\pm(2 \% + (n \times 0.2\%) + 1 \text{ A})$ $n \leq 25$
				1 A $A \geq 1000$ A	$\pm(2 \% + (n \times 0.5\%) + 1 \text{ A})$ $n > 25$
	MN93 clamp	200 mA	200 A	100 mA	$\pm(2 \% + (n \times 0.2\%) + 1 \text{ A})$ $n \leq 25$
					$\pm(2 \% + (n \times 0.5\%) + 1 \text{ A})$ $n > 25$
	E3N clamp (10 mV/A) MN93A clamp (100 A)	100 mA	100 A	10 mA $A < 100$ A	$\pm(2 \% + (n \times 0.2\%) + 100 \text{ mA})$ $n \leq 25$
				100 mA $A \geq 100$ A	$\pm(2 \% + (n \times 0.5\%) + 100 \text{ mA})$ $n > 25$
	E3N clamp (100 mV/A)	10 mA	10 A	1 mA $A < 10$ A	$\pm(2 \% + (n \times 0.2\%) + 10 \text{ mA})$ $n \leq 25$
				10 mA $A \geq 10$ A	$\pm(2 \% + (n \times 0.5\%) + 10 \text{ mA})$ $n > 25$
	MN93A clamp (5 A) 5 A adapter Essailec <sup>®</sup> adapter	5 mA	5 A	1 mA	$\pm(2 \% + (n \times 0.2\%) + 10 \text{ mA})$ $n \leq 25$
					$\pm(2 \% + (n \times 0.5\%) + 10 \text{ mA})$ $n > 25$
	AmpFLEX™ A193 MiniFLEX MA193 (10 kA)	10 A	10 kA	1 A $A < 10$ kA	$\pm(2 \% + (n \times 0.3\%) + 1 \text{ A} + (A_{\text{FRMS}}^{(3)} \times 0.1\%))$ $n \leq 25$
				10 A $A \geq 10$ kA	$\pm(2 \% + (n \times 0.6\%) + 1 \text{ A} + (A_{\text{FRMS}}^{(3)} \times 0.1\%))$ $n > 25$
	AmpFLEX™ A193 MiniFLEX MA193 (6500 A)	10 A	6,500 A	100 mA $A < 1,000$ A	$\pm(2 \% + (n \times 0.3\%) + 1 \text{ A} + (A_{\text{FRMS}}^{(3)} \times 0.1\%))$ $n \leq 25$
1 A $A \geq 1,000$ A				$\pm(2 \% + (n \times 0.6\%) + 1 \text{ A} + (A_{\text{FRMS}}^{(3)} \times 0.1\%))$ $n > 25$	
AmpFLEX™ A193 MiniFLEX MA193 (100 A)	100 mA	100 A	10 mA $A < 100$ A	$\pm(2 \% + (n \times 0.2\%) + 30 \text{ pt})$ $n \leq 25$	
			100 mA $A \geq 100$ A	$\pm(2 \% + (n \times 0.5\%) + 30 \text{ pt})$ $n > 25$	

(1) In 1,000 V<sub>RMS</sub>, category III, provided that the voltage between each of the terminals and earth does not exceed 1,000 V<sub>RMS</sub>.

(2) Two-phase (opposite phases) – same note as (1).

(3) RMS value of the fundamental.

Measurement		Measurement range (with unity ratio)		Display resolution (with unity ratio)	Maximum intrinsic error
		Minimum	Maximum		
RMS distortion current (Ad) <sup>(1)</sup>	J93 clamp	1 A	3500 A	1 A	$\pm((n_{\max} \times 0.4\%) + 1 \text{ A})$
	C193 clamp PAC93 clamp	1 A	1000 A	100 mA A < 1000 A	$\pm((n_{\max} \times 0.4\%) + 1 \text{ A})$
				1 A A ≥ 1000 A	
	MN93 clamp	200 mA	200 A	100 mA	$\pm((n_{\max} \times 0.4\%) + 1 \text{ A})$
	E3N clamp (10 mV/A) MN93A clamp (100 A)	0.1 A	100 A	10 mA A < 100 A	$\pm((n_{\max} \times 0.4\%) + 100 \text{ mA})$
				100 mA A ≥ 100 A	
	E3N clamp (100 mV/A)	10 mA	10 A	1 mA A < 10 A	$\pm((n_{\max} \times 0.4\%) + 10 \text{ mA})$
				10 mA A ≥ 10 A	
	MN93A clamp (5 A) 5 A adapter Essailec® adapter	5 mA	5 A	1 mA	$\pm((n_{\max} \times 0.4\%) + 10 \text{ mA})$
AmpFLEX™ A193 MiniFLEX MA193 (10 kA)	10 A	10 kA	1 A A < 10 kA	$\pm((n_{\max} \times 0.4\%) + 1 \text{ A})$	
			10 A A ≥ 10 kA		
AmpFLEX™ A193 MiniFLEX MA193 (6500 A)	10 A	6,500 A	100 mA A < 1,000 A	$\pm((n_{\max} \times 0.4\%) + 1 \text{ A})$	
			1 A A ≥ 1,000 A		
AmpFLEX™ A193 MiniFLEX MA193 (100 A)	100 mA	100 A	10 mA A < 100 A	$\pm(n_{\max} \times 0.5\%) + 30 \text{ pt})$	
			100 mA A ≥ 100 A		

(1)  $n_{\max}$  is the highest order for which the harmonic ratio is non-zero.

### Severity of short-term flicker

Rectangular variations per minute (50% duty cycle)	Maximum intrinsic error of the short-term flicker severity measurement (PST)			
	120 V lamp 60 Hz network		230 V lamp 50 Hz network	
1	PST ∈ [0.5 ; 4]	± 5%	PST ∈ [0.5 ; 4]	± 5%
2	PST ∈ [0.5 ; 5]	± 5%	PST ∈ [0.5 ; 5]	± 5%
7	PST ∈ [0.5 ; 7]	± 5%	PST ∈ [0.5 ; 8]	± 5%
39	PST ∈ [0.5 ; 12]	± 5%	PST ∈ [0.5 ; 10]	± 5%
110	PST ∈ [0.5 ; 12]	± 5%	PST ∈ [0.5 ; 10]	± 5%
1620	PST ∈ [0.25 ; 12]	± 15%	PST ∈ [0.25 ; 10]	± 15%

### Range of current and voltage ratios

Ratio	Minimum	Maximum
Voltage	$\frac{100}{1,000 \times \sqrt{3}}$	$\frac{9,999,900 \times \sqrt{3}}{0,1}$
Current <sup>(1)</sup>	1	60,000 / 1

(1) Only for the MN93A clamp (5 A), the 5 A adapter and the Essailec® adapter.

**Measurement ranges after application of the ratios**

Measurement		Measurement range	
		Minimum with minimum ratio(s)	Maximum with maximum ratio(s)
RMS & RMS ½ voltage	simple	120 mV	170 GV
	compound	120 mV	340 GV
Direct voltage (DC)	simple	120 mV	200 GV
	compound	120 mV	400 GV
Peak voltage (PK)	simple	160 mV	240 GV
	compound	320 mV	480 GV
RMS & RMS ½ current		5 mA	300 kA
Direct current (DC)		10 mA	5 kA
Peak current (PK)		7 mA	420 kA
Active power (P)		600 µW	51 PW <sup>(3)</sup>
DC power (Pdc)		1,2 mW	1 PW <sup>(3)</sup>
Reactive power (Q <sub>1</sub> ) non-active (N) and distortion power (D)		600 µvar	51 Pvar <sup>(3)</sup>
Apparent power (S)		600 µVA	51 PVA <sup>(3)</sup>
Active energy (Ph)		1 mWh	9 999 999 EWh <sup>(1)</sup>
DC energy (Pdch)		1 mWh	9 999 999 EWh <sup>(2)</sup>
Reactive energy (Q <sub>1</sub> h) non-active (Nh) and distortion energy (Dh)		1 mvarh	9 999 999 Evarh <sup>(1)</sup>
Apparent energy (Sh)		1 mVAh	9 999 999 EVAh <sup>(1)</sup>

(1) The energy corresponds to more than 22,000 years of the associated maximum power (maximum ratios).

(2) The energy Pdch corresponds to more than 1 million years at maximum power Pdc (maximum ratios).

(3) Maximum value calculated for a 2-wire single-phase connection (phase-to-ground voltage).

### 15.3.5. CURRENT SENSOR CHARACTERISTICS (AFTER LINEARIZATION)

Sensor errors are offset by a typical correction inside the device. This typical correction, applied to the phase and amplitude, depends on the type of sensor connected (detected automatically) and the gain in the current acquisition channel used.

The RMS current measurement error and phase error are additional errors (which must therefore be added to the device errors), indicated as influences on the calculations carried out by the analyser (powers, energies, power factors, tangents, etc.).

Type of sensor	RMS current ( $I_{RMS}$ )	Maximum error for $I_{RMS}$	Maximum error for $\Phi$
AmpFLEX™ A193 6500 A / 10 kA	[10 A ; 100 A[	±3 %	±1°
	[100 A ; 10 kA]	±2 %	±0.5°
MiniFLEX MA193 6500 A / 10 kA	[10 A ; 100 A[	±3 %	±1°
	[100 A ; 10 kA]	±2 %	±0.5°
AmpFLEX™ A193 100 A	[100 mA ; 100 A]	±3 %	±1°
MiniFLEX MA193 100 A	[100 mA ; 100 A]	±3 %	±1°
J93 clamp 3500 A	[3 A ; 50 A]	-	-
	[50 A ; 100 A[	±(2 % + 2.5 A)	±4°
	[100 A ; 500 A[	±(1.5 % + 2.5 A)	±2°
	[500 A ; 2000 A[	±1 %	±1°
	[2000 A ; 3500 A]	±1 %	±1.5°
	]3500 A ; 5000 A] DC	±1 %	-
C193 clamp 1000 A	[1 A ; 10 A[	±0.8 %	±1°
	[10 A ; 100 A[	±0.3 %	±0.5°
	[100 A ; 1000 A]	±0.2 %	±0.3°
PAC93 clamp 1000 A	[1 A ; 10 A[	±(1.5 % + 1 A)	-
	[10 A ; 100 A[	±(1.5 % + 1 A)	±2°
	[100 A ; 200 A[	±3 %	±1.5°
	[200 A ; 800 A[	±3 %	±1.5°
	[800 A ; 1000 A[	±5 %	±1.5°
	]1000 A ; 1300 A] DC	±5 %	-
MN93 clamp 200 A	[200 mA ; 500 mA[	-	-
	[500 mA ; 10 A[	±(3 % + 1 A)	-
	[10 A ; 40 A[	±(2.5 % + 1 A)	±3°
	[40 A ; 100 A[	±(2.5 % + 1 A)	±3°
	[100 A ; 200 A]	±(1 % + 1 A)	±2°
MN93A clamp 100 A	[100 mA ; 1 A[	±(0.7 % + 2 mA)	±1.5°
	[1 A ; 100 A]	±0.7 %	±0.7°
E3N clamp (10 mV/A) 100A	[100 mA ; 40 A[	±(2 % + 50 mA)	±0.5°
	[40 A ; 100 A]	±7.5 %	±0.5°
E3N clamp (100 mV/A) 10A	[10 mA ; 10 A]	±(1.5 % + 50 mA)	±1°
Clamp MN93A 5 A	[5 mA ; 50 mA[	±(1 % + 100 µA)	±1.7°
	[50 mA ; 500 mA[	±1 %	±1°
	[500 mA ; 5 A]	±0.7 %	±1°
5 A adapter Essailec® adapter	[5 mA ; 50 mA[	±(1 % + 1.5 mA)	±1°
	[50 mA ; 1 A[	±(0.5 % + 1 mA)	±0°
	[1 A ; 5 A]	±0.5 %	±0°

**Note:** This table does not take into account possible distortion of the measured signal (THD) because of the physical limitations of the current sensor (saturation of the magnetic circuit or of the Hall-effect cell). Class B under standard IEC61000-4-30.

## 15.4. CLASS B UNDER STANDARD IEC 61000-4-30

### 15.4.1. CONFORMITY OF THE DEVICE

The device and its Power Analyzer Transfer 2 operating software are compliant with class B of standard IEC61000-4-30 for the following parameters:

- Industrial frequency,
- Supply voltage amplitude,
- Flicker,
- Supply voltage brownouts,
- Temporary overvoltages at industrial frequency,
- Supply voltage blackouts,
- Voltage transients,
- Supply voltage unbalance,
- Voltage harmonics.

**Remark:** To ensure this compliance, trend recordings (Trend mode) must be made with:

- A recording period of one second,
- The quantities Vrms and Urms selected,
- The quantities V-h01 and U-h01 selected.

### 15.4.2. UNCERTAINTIES AND MEASUREMENT RANGES

Parameter		Range	Uncertainty	U <sub>din</sub>
Industrial frequency		[42,5 Hz ; 69 Hz]	±10 mHz	[50 V ; 1000 V]
Supply voltage amplitude		[50 V ; 1000 V]	±1 % of U <sub>din</sub>	[50 V ; 1000 V]
Flicker		[0,25 ; 12]	See the corresponding tables	V ∈ {120 V ; 230 V} U ∈ {207 V ; 400 V}
Supply voltage brownouts	Residual voltage	[5 % of U <sub>din</sub> ; U <sub>din</sub> ]	±2 % of U <sub>din</sub>	[50 V ; 1000 V]
	Duration	[10 ms ; 65,535 days]	80 ppm ±10 ms (maximum) 30 ppm ±10 ms (typical)	
Temporary overvoltages at industrial frequency	Maximum amplitude	[U <sub>din</sub> ; 150 % of U <sub>din</sub> ]	±2 % of U <sub>din</sub>	[50 V ; 1000 V]
	Duration	[10 ms ; 65,535 days]	80 ppm ±10 ms (maximum) 30 ppm ±10 ms (typical)	
Supply voltage blackouts	Duration	[10 ms ; 65,535 days]	80 ppm ±10 ms (maximum) 30 ppm ±10 ms (typical)	[50 V ; 1000 V]
Supply voltage unbalance		[0 % ; 10 %]	±0.3 % or ±3 ct	[50 V ; 1000 V]
Voltage harmonics	Rate	[0 % ; 1500 %]	±(2.5 % + 5 ct)	[50 V ; 1000 V]
	Voltage	[2 V ; 1000 V]	±(2.5 % + 1 V)	

### 15.4.3. UNCERTAINTY OF THE REAL-TIME CLOCK

The uncertainty of the real-time clock is 80 ppm at most (device 3 years old used at an ambient temperature of 50°C). With a new device used at 25°C, this uncertainty is only 30 ppm.

## 16. APPENDICES

This section presents the mathematical formulae used in calculating various parameters.

### 16.1. MATHEMATICAL FORMULAE

#### 16.1.1. NETWORK FREQUENCY AND SAMPLING

Sampling is controlled by (locked to) the network frequency so as to deliver 256 samples per cycle from 40 Hz to 70 Hz. This locking is essential for many calculations, including reactive power, distorting power, fundamental power factor, unbalance, and harmonic factors and angles.

The instantaneous frequency is measured by analysing eight consecutive positive-going zero crossings on the signal in question after digital low-pass filtering and digital suppression of the DC component (i.e. 7 periods filtered). The time of the zero crossing is determined precisely by linear interpolation between two samples.

The device is capable of calculating an instantaneous frequency simultaneously on each of the 3 phases in voltage (phase-to-neutral for distribution systems with neutral and phase-to-phase for distribution systems without neutral) or in current. It then chooses one from among two or three of them as the official instantaneous frequency.

The network frequency over one second is the harmonic mean of the instantaneous frequencies.

The signals are acquired using a 16-bit converter and (for current acquisition) dynamic gain switches.

#### 16.1.2. WAVEFORM MODE

##### 16.1.2.1. RMS values of half-cycle voltage and current (excluding neutral)

Half-cycle RMS phase-to-neutral voltage of phase (i+1) with  $i \in [0; 2]$ .

$$V_{dem}[i] = \sqrt{\frac{1}{NechDemPer} \cdot \sum_{n=Zéro}^{(Zéro\ suivant)-1} V[i][n]^2}$$

Half-cycle RMS phase-to-phase voltage of phase (i+1) with  $i \in [0; 2]$ .

$$U_{dem}[i] = \sqrt{\frac{1}{NechDemPer} \cdot \sum_{n=Zéro}^{(Zéro\ suivant)-1} U[i][n]^2}$$

Half-cycle RMS current of phase (i+1) with  $i \in [0; 2]$ .

$$A_{dem}[i] = \sqrt{\frac{1}{NechDemPer} \cdot \sum_{n=Zéro}^{(Zéro\ suivant)-1} A[i][n]^2}$$

**Notes:** these values are calculated for each half-cycle so as not to miss any fault.

NechDemPer is the number of samples in the half cycle.

##### 16.1.2.2. Minimum and maximum half-cycle RMS values (excluding neutral)

Minimum and maximum RMS phase-to-neutral voltages of phase (i+1) with  $i \in [0; 2]$ .

$$V_{max}[i] = \max(V_{dem}[i]), \quad V_{min}[i] = \min(V_{dem}[i])$$

Minimum and maximum RMS phase-to-phase voltages of phase (i+1) with  $i \in [0; 2]$ .

$$U_{max}[i] = \max(U_{dem}[i]), \quad U_{min}[i] = \min(U_{dem}[i])$$

Minimum and maximum RMS currents of phase (i+1) with  $i \in [0; 2]$ .

$$A_{max}[i] = \max(A_{dem}[i]), \quad A_{min}[i] = \min(A_{dem}[i])$$

**Note:** The duration of the evaluation is left to the user's discretion (reset by pressing the ↵ key in the MAX-MIN mode).

### 16.1.2.3. DC quantities (neutral included except Udc – reassessment every second)

Phase-to-ground DC voltage of phase (i+1) with  $i \in [0; 3]$  ( $i = 3 \in$  neutral-ground voltage)

$$V_{dc}[i] = \frac{1}{NechSec} \cdot \sum_{n=0}^{NechSec-1} V[i][n]$$

Phase-to-phase DC voltage of phase (i+1) with  $i \in [0; 2]$

$$U_{dc}[i] = \frac{1}{NechSec} \cdot \sum_{n=0}^{NechSec-1} U[i][n]$$

DC current of phase (i+1) with  $i \in [0; 3]$  ( $i = 3 \in$  neutral current)

$$A_{dc}[i] = \frac{1}{NechSec} \cdot \sum_{n=0}^{NechSec-1} A[i][n]$$

**Remark:** The value NechSec is the number of samples per second.

### 16.1.2.4. Severity of Short-term flicker – 10 minutes (excluding neutral)

Method based on the IEC61000-4-15 standard.

The input values are half-period RMS voltages (phase-to-neutral for distribution systems with neutral, phase-to-phase for distribution systems without neutral). Blocks 3 and 4 are generated digitally. The classifier of block 5 has 128 levels.

The value of PST[i] is updated every 10 minutes (phase (i+1) with  $i \in [0; 2]$ ).

**Note:** The user can reset the PST calculation by pressing the  $\leftarrow$  key in the  Summary mode. It is important to note that the 10-minute intervals do not necessarily start on an integer multiple of 10 minutes of universal time coordinated (UTC).

### 16.1.2.5. Severity of LONG-term flicker – 2 hours (excluding neutral)

Method based on the IEC61000-4-15 standard.

$$PLT[i] = \sqrt[3]{\frac{\sum_{n=0}^{11} PST[i][n]^3}{12}}$$

The values of PST[i][n] are consecutive and 10 minutes apart. The value of PLT[i] (phase (i+1) with  $i \in [0; 2]$ ) calculated in a two-hour window is updated either:

- every 10 minutes (Sliding long-term flicker – Configuration >Calculation methods >PLT)
- or every 2 hours (Non-sliding long-term flicker – Configuration >Calculation methods >PLT)

**Note:** The user can reset the PLT calculation by pressing the  $\leftarrow$  key in the  Summary mode. It is important to note that the 2-hour intervals do not necessarily start on an integer multiple of 10 minutes (sliding PLT) or of 2 hours (non-sliding PLT) of universal time coordinated (UTC).

### 16.1.2.6. Peak values (neutral included except Upp and Upm – reassessment every second)

Positive and negative phase-to-neutral peak voltages of phase (i+1) with  $i \in [0; 3]$  ( $i = 3 \leftrightarrow$  neutral).

$$V_{pp}[i] = \max(V[i][n]), \quad V_{pm}[i] = \min(V[i][n]) \quad n \in [0; N]$$

Positive and negative phase-to-phase peak voltages of phase (i+1) with  $i \in [0; 2]$ .

$$U_{pp}[i] = \max(U[i][n]), \quad U_{pm}[i] = \min(U[i][n]) \quad n \in [0; N]$$

Positive and negative peak currents of phase (i+1) with  $i \in [0; 3]$  ( $i = 3 \leftrightarrow$  neutral).

$$A_{pp}[i] = \max(A[i][n]), \quad A_{pm}[i] = \min(A[i][n]) \quad n \in [0; N]$$

**Note:** The duration of the evaluation is left to the user's discretion (reset by pressing the  $\leftarrow$  key in the  MAX-MIN mode).



### 16.1.2.7. Peak factors (neutral included except Ucf – over one second)

Peak factor of phase-to-neutral voltage of phase (i+1) with  $i \in [0; 3]$  ( $i = 3 \Leftrightarrow$  neutral).

$$V_{cf}[i] = \frac{\max(|V_{pp}[i]|, |V_{pm}[i]|)}{\sqrt{\frac{1}{NechSec} \cdot \sum_{n=0}^{NechSec-1} V[i][n]^2}}$$

Peak factor of phase-to-phase voltage of phase (i+1) with  $i \in [0; 2]$ .

$$U_{cf}[i] = \frac{\max(|U_{pp}[i]|, |U_{pm}[i]|)}{\sqrt{\frac{1}{NechSec} \cdot \sum_{n=0}^{NechSec-1} U[i][n]^2}}$$

Peak factor of current of phase (i+1) with  $i \in [0; 3]$  ( $i = 3 \Leftrightarrow$  neutral).

$$A_{cf}[i] = \frac{\max(|A_{pp}[i]|, |A_{pm}[i]|)}{\sqrt{\frac{1}{NechSec} \cdot \sum_{n=0}^{NechSec-1} A[i][n]^2}}$$

**Note:** NechSec is the number of samples in the second. The duration of evaluation of the peak values here is one second.

### 16.1.2.8. Rms values (neutral included except Urms – over one second)

RMS phase-to-neutral voltage of phase (i+1) with  $i \in [0; 3]$  ( $i = 3 \Leftrightarrow$  neutral).

$$V_{rms}[i] = \sqrt{\frac{1}{NechSec} \cdot \sum_{n=0}^{NechSec-1} V[i][n]^2}$$

RMS phase-to-phase voltage of phase (i+1) with  $i \in [0; 2]$ .

$$U_{rms}[i] = \sqrt{\frac{1}{NechSec} \cdot \sum_{n=0}^{NechSec-1} U[i][n]^2}$$

RMS current of phase (i+1) with  $i \in [0; 3]$  ( $i = 3 \Leftrightarrow$  neutral).

$$A_{rms}[i] = \sqrt{\frac{1}{NechSec} \cdot \sum_{n=0}^{NechSec-1} A[i][n]^2}$$

**Note:** NechSec is the number of samples in the second.

### 16.1.2.9. Negative-sequence unbalance rates (three-phase connection – over one second)

These are calculated from the filtered RMS vector values (over one second)  $V_{Frms}[i]$  and  $A_{Frms}[i]$  for distribution systems with neutral and  $U_{Frms}[i]$  and  $A_{Frms}[i]$  for distribution systems without neutral. (Ideally the fundamental vectors of the signals). The formulas used make use of Fortescue's symmetrical components from Fortescue's negative-sequence transformation.

**Note:** The operations are vector operations in complex notation with  $a = e^{j\frac{2\pi}{3}}$

Positive-sequence fundamental symmetrical phase-to-ground voltage (vector) in a distribution system with neutral

$$V_{rms+} = \frac{1}{3} (V_{Frms}[0] + a \cdot V_{Frms}[1] + a^2 \cdot V_{Frms}[2])$$

Negative-sequence fundamental symmetrical phase-to-ground voltage (vector) in a distribution system with neutral

$$V_{rms-} = \frac{1}{3} (V_{Frms}[0] + a^2 \cdot V_{Frms}[1] + a \cdot V_{Frms}[2])$$

Negative-sequence unbalance factor of the phase-to-ground voltages in a distribution system with neutral

$$V_{unb} = \frac{|V_{rms-}|}{|V_{rms+}|}$$

**Remark:** The following quantities are saved with the negative-sequence unbalance factor in a trend recording:  $V_{ns} = |V_{rms-}|$  and  $V_{ps} = |V_{rms+}|$  (the norms of the negative-sequence and positive-sequence fundamental symmetrical components, respectively).

Positive-sequence phase-to-phase fundamental symmetrical voltage (vector) in a distribution system without neutral

$$U_{rms+} = \frac{1}{3}(UF_{rms}[0] + a \cdot UF_{rms}[1] + a^2 \cdot UF_{rms}[2])$$

Negative-sequence phase-to-phase fundamental symmetrical voltage (vector) in a distribution system without neutral

$$U_{rms-} = \frac{1}{3}(UF_{rms}[0] + a^2 \cdot UF_{rms}[1] + a \cdot UF_{rms}[2])$$

Negative-sequence unbalance factor of the phase-to-phase voltages in a distribution system without neutral

$$U_{unb} = \frac{|U_{rms-}|}{|U_{rms+}|}$$

**Remark:** The following quantities are saved with the negative-sequence unbalance factor in a trend recording:  $U_{ns} = |U_{rms-}|$  and  $U_{ps} = |U_{rms+}|$  (the norms of the negative-sequence and positive-sequence fundamental symmetrical components, respectively).

Positive-sequence fundamental symmetrical current (vector)

$$I_{rms+} = \frac{1}{3}(AF_{rms}[0] + a \cdot AF_{rms}[1] + a^2 \cdot AF_{rms}[2])$$

Reverse-sequence fundamental symmetrical current (vector)

$$I_{rms-} = \frac{1}{3}(AF_{rms}[0] + a^2 \cdot AF_{rms}[1] + a \cdot AF_{rms}[2])$$

Negative-sequence unbalance rate of the current

$$A_{unb} = \frac{|I_{rms-}|}{|I_{rms+}|}$$

**Remark:** The following quantities are saved with the negative-sequence unbalance factor in a trend recording:  $I_{ns} = |I_{rms-}|$  and  $I_{ps} = |I_{rms+}|$  (the norms of the negative-sequence and positive-sequence fundamental symmetrical components, respectively).

#### 16.1.2.10. Fundamental rms values (excluding neutral – over one second)

These are calculated from the filtered vector (instantaneous) values. A digital filter made up of 6 low-pass order 2 infinite pulse response Butterworth filters and one high-pass order 2 infinite pulse response Butterworth filter is used to extract the fundamental components.

#### 16.1.2.11. Fundamental angular values (excluding neutral – over one second)

These are calculated from the filtered vector (instantaneous) values. A digital filter made up of 6 low-pass order 2 infinite pulse response Butterworth filters and one high-pass order 2 infinite pulse response Butterworth filter is used to extract the fundamental components. The angular values calculated are those between:

- 2 phase-to-neutral voltages
- 2 line currents
- 2 phase-to-phase voltages
- One phase-to-neutral voltage and one line current (distribution systems with neutral)
- One phase-to-phase voltage and one line current (2-wire two-phase distribution systems)

### 16.1.3. HARMONIC MODE

#### 16.1.3.1. FFT (neutral included except for U<sub>harm</sub> and V<sub>Aharm</sub> – over 4 consecutive periods every second)

These calculations are carried out by FFT (16 bits), 1024 points over four cycles, with a rectangular window (see IEC61000-4-7). From the real parts  $b_k$  and the imaginary parts  $a_k$ , the harmonic factor is calculated for each order (j) and for each phase (i) V<sub>harm</sub>[i][j], U<sub>harm</sub>[i][j] and A<sub>harm</sub>[i][j] with respect to the fundamental and the angles V<sub>ph</sub>[i][j], U<sub>ph</sub>[i][j] and A<sub>ph</sub>[i][j] with respect to the fundamental. For the neutral-earth voltage and the neutral current, the level of harmonics is calculated for each order (j) V<sub>harm</sub>[3][j] and A<sub>harm</sub>[3][j] with respect to the total RMS value (AC+DC) of the complete signal (the harmonic angles are not calculated).

**Note:** The calculations are performed sequentially: {V1; A1} then {V2; A2} then {V3; A3} then {UN ; AN} then {U1; U2} and finally {U3}. In the case of a 2-wire two-phase distribution source, the couple {V1; A1} is replaced by the couple {U1; A1}.

The level in % with respect to the fundamental [% f]  $\Leftrightarrow \tau_k = \frac{c_k}{c_4} 100$

The level in % with respect to the total RMS value [% r]  $\Leftrightarrow \tau_k = \frac{c_k}{\sqrt{\sum_{m=0}^{50} C_{4m}^2}} 100$

The angle with respect to the fundamental in degrees [°]  $\Leftrightarrow \varphi_k = \arctan\left(\frac{a_k}{b_k}\right) - \varphi_4$

$$\text{with } \begin{cases} c_k = |b_k + j a_k| = \sqrt{a_k^2 + b_k^2} \\ b_k = \frac{1}{512} \sum_{s=0}^{1024} F_s \cdot \sin\left(\frac{k\pi}{512} s + \varphi_k\right) \\ a_k = \frac{1}{512} \sum_{s=0}^{1024} F_s \cdot \cos\left(\frac{k\pi}{512} s + \varphi_k\right) \\ c_0 = \frac{1}{1024} \sum_{s=0}^{1024} F_s \end{cases}$$

$c_k$  is the amplitude of the component of order  $m = \frac{k}{4}$  with a frequency  $f_k = \frac{k}{4} f_4$ .

$F_s$  is the sampled signal at the fundamental frequency  $f_4$ .

$c_0$  is the DC component.

k is the index of the spectral spike (the order of the harmonic component is  $m = \frac{k}{4}$ ).

**Note:** The power harmonic factors are calculated by multiplying the phase-to-neutral voltage harmonic factors by the current harmonic factors. The power harmonic angles (V<sub>Aharm</sub>[i][j] and V<sub>Aph</sub>[i][j]) are calculated by differentiating the phase-to-neutral voltage harmonic angles with the current harmonic angles. In the case of a 2-wire two-phase distribution source, the phase-to-neutral voltage V1 is replaced by the phase-to-phase voltage U1 and one obtains the harmonic power levels U<sub>Aharm</sub>[0][j] and the harmonic power angles U<sub>Aph</sub>[0][j].

#### 16.1.3.2. Harmonic distortions

Two global values giving the relative quantity of the harmonic are calculated:

- the THD as a proportion of the fundamental (also noted THD-F),
- the THD as a proportion of the total RMS-AC value (also noted THD-R).

Total harmonic distortion of phase (i+1) with  $i \in [0; 2]$  (THD-F)

$$V_{thdf}[i] = \frac{\sqrt{\sum_{n=2}^{50} V_{harm}[i][n]^2}}{V_{harm}[i][1]}, \quad U_{thdf}[i] = \frac{\sqrt{\sum_{n=2}^{50} U_{harm}[i][n]^2}}{U_{harm}[i][1]}, \quad A_{thdf}[i] = \frac{\sqrt{\sum_{n=2}^{50} A_{harm}[i][n]^2}}{A_{harm}[i][1]}$$

Total harmonic distortion of channel (i+1) with  $i \in [0; 3]$  (THD-R).

$$V_{thdr}[i] = \sqrt{\frac{\sum_{n=2}^{50} V_{harm}[i][n]^2}{\sum_{n=1}^{50} V_{harm}[i][n]^2}}, U_{thdr}[i] = \sqrt{\frac{\sum_{n=2}^{50} U_{harm}[i][n]^2}{\sum_{n=1}^{50} U_{harm}[i][n]^2}}, A_{thdr}[i] = \sqrt{\frac{\sum_{n=2}^{50} A_{harm}[i][n]^2}{\sum_{n=1}^{50} A_{harm}[i][n]^2}}$$

The THD as a proportion of the RMS-AC value (THD-R) is also called the distortion factor (DF).

### 16.1.3.3. Harmonic loss factor (without neutral – over 4 consecutive periods every second)

Harmonic loss factor of the phase (i+1) with  $i \in [0; 2]$

$$FHL[i] = \frac{\sum_{n=1}^{n=50} n^2 \cdot A_{harm}[i][n]^2}{\sum_{n=1}^{n=50} A_{harm}[i][n]^2}$$

### 16.1.3.4. K factor (excluding neutral – over 4 consecutive cycles every second)

K factor for phase (i+1) with  $i \in [0; 2]$ ,  $e \in [0.05; 0.1]$  and  $q \in [1.5; 1.7]$

$$FK[i] = \sqrt{1 + \frac{e}{1+e} \cdot \frac{\sum_{n=2}^{n=50} n^q \cdot A_{harm}[i][n]^2}{\sum_{n=1}^{n=50} A_{harm}[i][n]^2}}$$

### 16.1.3.5. Sequence harmonics (over 3 × (4 consecutive cycles) every second)

#### Negative-sequence harmonics

$$A_{harm\_} = \frac{1}{3} \sum_{i=0}^2 \frac{\sum_{j=0}^7 A_{harm}[i][3j+2]}{A_{harm}[i][1]}$$

Three-phase systems with neutral

$$V_{harm\_} = \frac{1}{3} \sum_{i=0}^2 \frac{\sum_{j=0}^7 V_{harm}[i][3j+2]}{V_{harm}[i][1]}$$

Three-phase systems without neutral

$$U_{harm\_} = \frac{1}{3} \sum_{i=0}^2 \frac{\sum_{j=0}^7 U_{harm}[i][3j+2]}{U_{harm}[i][1]}$$

#### Zero-sequence harmonics

$$A_{harm_0} = \frac{1}{3} \sum_{i=0}^2 \frac{\sum_{j=0}^7 A_{harm}[i][3j+3]}{A_{harm}[i][1]}$$

Three-phase systems with neutral

$$V_{harm_0} = \frac{1}{3} \sum_{i=0}^2 \frac{\sum_{j=0}^7 V_{harm}[i][3j+3]}{V_{harm}[i][1]}$$

Three-phase systems without neutral

$$U_{harm_0} = \frac{1}{3} \sum_{i=0}^2 \frac{\sum_{j=0}^7 U_{harm}[i][3j+3]}{U_{harm}[i][1]}$$

### Positive -sequence harmonics

$$A_{harm_+} = \frac{1}{3} \sum_{i=0}^2 \frac{\sum_{j=0}^7 A_{harm}[i][3j+4]}{A_{harm}[i][1]}$$

Three-phase systems with neutral

$$V_{harm_+} = \frac{1}{3} \sum_{i=0}^2 \frac{\sum_{j=0}^7 V_{harm}[i][3j+4]}{V_{harm}[i][1]}$$

Three-phase systems without neutral

$$U_{harm_+} = \frac{1}{3} \sum_{i=0}^2 \frac{\sum_{j=0}^7 U_{harm}[i][3j+4]}{U_{harm}[i][1]}$$

## 16.1.4. POWER

Powers without neutral – over one second

### 16.1.4.1. Distribution system with neutral

Active power of phase (i+1) with  $i \in [0; 2]$ .

$$P[i] = W[i] = \frac{1}{NechSec} \cdot \sum_{n=0}^{NechSec-1} V[i][n] \cdot A[i][n]$$

DC power of phase (i+1) with  $i \in [0; 2]$ .

$$P_{dc}[i] = W_{dc}[i] = V_{dc}[i] \cdot A_{dc}[i]$$

Apparent power of phase (i+1) with  $i \in [0; 2]$ .

$$S[i] = VA[i] = V_{rms}[i] \cdot A_{rms}[i]$$

Reactive power of phase (i+1) with  $i \in [0; 2]$  (Non-active quantities broken down).

$$Q_1[i] = VARF[i] = \frac{1}{NechSec} \cdot \sum_{n=0}^{NechSec-1} VF[i][n - \frac{NechPer}{4}] \cdot AF[i][n]$$

Distortion power of the phase (i+1) with  $i \in [0; 2]$  (Non-active quantities broken down).

$$D[i] = V_{AD}[i] = \sqrt{S[i]^2 - P[i]^2 - Q_1[i]^2}$$

Non-active power of phase (i+1) with  $i \in [0; 2]$  (Non-active quantities broken down).

$$N[i] = VAR[i] = \sqrt{S[i]^2 - P[i]^2}$$

Total active power  
 $P[3] = W[3] = P[0] + P[1] + P[2]$

Total DC power  
 $Pdc[3] = Wdc[3] = Pdc[0] + Pdc[1] + Pdc[2]$

Total apparent power  
 $S[3] = VA[3] = S[0] + S[1] + S[2]$

Total reactive power (Non-active quantities broken down)  
 $Q_1[3] = VARF[3] = Q_1[0] + Q_1[1] + Q_1[2]$

Total distortion power (Non-active quantities broken down)  
 $D[3] = VAD[3] = \sqrt{S[3]^2 - P[3]^2 - Q_1[3]^2}$

Total non-active power (Non-active quantities non broken down)  
 $N[3] = VAR[3] = \sqrt{S[3]^2 - P[3]^2}$

#### 16.1.4.2. Three-phase system with virtual neutral

Three-phase distribution systems without neutral are considered as a whole (no phase-by-phase power calculation). The device therefore displays only the total quantities.

The three-wattmeter method with virtual neutral is applied for the calculation of the total active power, of the total reactive power and of the total DC power.

Total active power.

$$P[3]=W[3]= \sum_{i=0}^2 \left( \frac{1}{NechSec} \sum_{n=0}^{NechSec-1} V[i][n].A[i][n] \right)$$

Total DC power.

$$Pdc[3]=Wdc[3]= \sum_{i=0}^2 (Vdc[i].Adc[i])$$

Total apparent power.

$$S[3]=VA[3]= \frac{1}{\sqrt{3}} \sqrt{(Urms^2[0]+Urms^2[1]+Urms^2[2])} \sqrt{(Arms^2[0]+Arms^2[1]+Arms^2[2])}$$

**Note:** This is the RMS total apparent power as defined in IEEE 1459-2010 for distribution systems without neutral.

Total reactive power (Non-active quantities broken down – Configuration > Methods of calculation > var)

$$Q_1[3]=VARF[3]= \sum_{i=0}^2 \left( \frac{1}{NechSec} \sum_{n=0}^{NechSec-1} VF[i] \left[ n - \frac{NechPer}{4} \right] . AF[i][n] \right)$$

Total distortion power (Non-active quantities broken down – Configuration > Methods of calculation > var)

$$D[3]=VAD [3]= \sqrt{(S[3]^2 - P[3]^2 - Q_1[3]^2)}$$

Total non-active power (Non-active quantities not broken down – Configuration > Methods of calculation > var)

$$N[3]=VAR [3]= \sqrt{(S[3]^2 - P[3]^2)}$$

### 16.1.4.3. Three-phase system without neutral

Three-phase distribution systems without neutral are considered as a whole (no phase-by-phase power calculation). The device therefore displays only the total quantities.

The two-wattmeter method (Aron method or two-element method) is applied for the calculation of the total active power, of the total reactive power and of the total DC power.

#### a) Reference in L1

Active power, Wattmeter 1

$$P[0] = W[0] = \frac{1}{NechSec} \cdot \sum_{n=0}^{NechSec-1} U[2][n] \cdot A[2][n]$$

Active power, Wattmeter 2

$$P[1] = W[1] = \frac{1}{NechSec} \cdot \sum_{n=0}^{NechSec-1} -U[0][n] \cdot A[1][n]$$

Reactive power, Wattmeter 1

$$Q_1[0] = VARF[0] = \frac{1}{NechSec} \cdot \sum_{n=0}^{NechSec-1} UF [2][n - \frac{NechPer}{4}] \cdot AF [2][n]$$

Reactive power, Wattmeter 2

$$Q_1[1] = VARF[1] = \frac{1}{NechSec} \cdot \sum_{n=0}^{NechSec-1} -UF [0][n - \frac{NechPer}{4}] \cdot AF [1][n]$$

DC power, Wattmeter 1

$$Pdc[0] = Wdc[0] = Udc[2] \cdot Adc[2]$$

DC power, Wattmeter 2

$$Pdc[1] = Wdc[1] = Udc[0] \cdot Adc[1]$$

#### b) Reference in L2

Active power, Wattmeter 1

$$P[0] = W[0] = \frac{1}{NechSec} \cdot \sum_{n=0}^{NechSec-1} U[0][n] \cdot A[0][n]$$

Active power, Wattmeter 2

$$P[1] = W[1] = \frac{1}{NechSec} \cdot \sum_{n=0}^{NechSec-1} -U[1][n] \cdot A[2][n]$$

Reactive power, Wattmeter 1

$$Q_1[0] = VARF[0] = \frac{1}{NechSec} \cdot \sum_{n=0}^{NechSec-1} UF [0][n - \frac{NechPer}{4}] \cdot AF [0][n]$$

Reactive power, Wattmeter 2

$$Q_1[1] = VARF[1] = \frac{1}{NechSec} \cdot \sum_{n=0}^{NechSec-1} -UF [1][n - \frac{NechPer}{4}] \cdot AF [2][n]$$

DC power, Wattmeter 1

$$Pdc[0] = Wdc[0] = Udc[0] \cdot Adc[0]$$

DC power, Wattmeter 2

$$Pdc[1] = Wdc[1] = Udc[1] \cdot Adc[2]$$

### c) Reference in L3

Active power, Wattmeter 1

$$P[0] = W[0] = \frac{1}{NechSec} \cdot \sum_{n=0}^{NechSec-1} -U[2][n] \cdot A[0][n]$$

Active power, Wattmeter 2

$$P[1] = W[1] = \frac{1}{NechSec} \cdot \sum_{n=0}^{NechSec-1} U[1][n] \cdot A[1][n]$$

Reactive power, Wattmeter 1

$$Q_1[0] = VARF[0] = \frac{1}{NechSec} \cdot \sum_{n=0}^{NechSec-1} -UF[2][n - \frac{NechPer}{4}] \cdot AF[0][n]$$

Reactive power, Wattmeter 2

$$Q_1[1] = VARF[1] = \frac{1}{NechSec} \cdot \sum_{n=0}^{NechSec-1} UF[1][n - \frac{NechPer}{4}] \cdot AF[1][n]$$

DC power, Wattmeter 1

$$Pdc[0] = Wdc[0] = -Udc[2] \cdot Adc[0]$$

DC power, Wattmeter 2

$$Pdc[1] = Wdc[1] = Udc[1] \cdot Adc[1]$$

### d) Calculation of the total quantities

Total active power

$$P[3] = W[3] = P[0] + P[1]$$

Total DC power

$$Pdc[3] = Wdc[3] = Pdc[0] + Pdc[1]$$

Total apparent power

$$S[3] = VA[3] = \frac{1}{\sqrt{3}} \sqrt{U_{rms}^2[0] + U_{rms}^2[1] + U_{rms}^2[2]} \sqrt{A_{rms}^2[0] + A_{rms}^2[1] + A_{rms}^2[2]}$$

**Note:** This is the total apparent RMS power as defined in IEEE 1459-2010 for distribution systems without neutral.

Total reactive power (Non-active quantities broken down – Configuration >Methods of calculation >VAR)

$$Q_1[3] = VARF[3] = Q_1[0] + Q_1[1]$$

Total distortion power (Non-active quantities broken down – Configuration >Calculation methods >VAR)

$$D[3] = VAD[3] = \sqrt{S[3]^2 - P[3]^2 - Q_1[3]^2}$$

Total non-active power (Non-active quantities not broken down – Configuration >Calculation methods >VAR)

$$N[3] = VAR[3] = \sqrt{S[3]^2 - P[3]^2}$$

#### 16.1.4.4. Two-phase systems without neutral

Two-phase distribution systems without neutral (2-wire two-phase) are treated as single-phase distribution system having their voltage reference on L2 rather than N (neutral).



Active power

$$P[0] = W[0] = \frac{1}{NechSec} \cdot \sum_{n=0}^{NechSec-1} U[0][n] \cdot A[0][n]$$

DC power

$$Pdc[0] = Wdc[0] = Udc[0] \cdot Adc[0]$$

Apparent power

$$S[0] = VA[0] = Urms[0] \cdot Arms[0]$$

Reactive power (Non-active quantities broken down – Configuration >Calculation methods >VAR)

$$Q_1[0] = VARF[0] = \frac{1}{NechSec} \cdot \sum_{n=0}^{NechSec-1} UF [0][n - \frac{NechPer}{4}] \cdot AF [0][n]$$

Distortion power (Non-active quantities broken down – Configuration >Calculation methods >VAR)

$$D[0] = AD [0] = \sqrt{S[0]^2 - P[0]^2 - Q_1[0]^2}$$

Non-active power (Non-active quantities not broken down – Configuration >Calculation methods >VAR)

$$N[0] = AR [0] = \sqrt{S[0]^2 - P[0]^2}$$

### 16.1.5. POWER RATIOS (EXCLUDING NEUTRAL – OVER ONE SECOND)

#### a) Distribution system with neutral

Power Factor of phase (i+1) with  $i \in [0; 2]$ .

$$PF [i] = \frac{P[i]}{S[i]}$$

Fundamental power factor of phase (i+1) or cosine of the angle of the phase-to-neutral voltage fundamental of phase (i+1) with respect to the current fundamental of phase (i+1) with  $i \in [0; 2]$

$$DPF[i] = \cos(\phi[i]) = \frac{\sum_{n=0}^{NechSec-1} VF[i][n] \cdot AF[i][n]}{\sqrt{\sum_{n=0}^{NechSec-1} VF[i][n]^2} \cdot \sqrt{\sum_{n=0}^{NechSec-1} AF[i][n]^2}}$$

**Note:** The fundamental power factor is also called the displacement factor.

Tangent of phase (i+1) or tangent of the angle of the phase-to-neutral voltage fundamental of phase (i+1) with respect to the current fundamental of phase (i+1) with  $i \in [0; 2]$

$$\tan[i] = \tan(\phi[i]) = \frac{\sum_{n=0}^{NechSec-1} VF[i][n - \frac{NechPer}{4}] \cdot AF[i][n]}{\sum_{n=0}^{NechSec-1} VF[i][n] \cdot AF[i][n]}$$

Total power factor

$$PF [3] = \frac{P[3]}{S[3]}$$

Total fundamental power factor

$$DPF[3] = \frac{P_1[3]}{\sqrt{P_1[3]^2 + Q_1[3]^2}}$$

With:

$$P_1[3] = \sum_{n=0}^{NechSec-1} VF[0][n] \cdot AF[0][n] + \sum_{n=0}^{NechSec-1} VF[1][n] \cdot AF[1][n] + \sum_{n=0}^{NechSec-1} VF[2][n] \cdot AF[2][n]$$

$$Q_1[3] = \sum_{n=0}^{NechSec-1} VF[0][n - \frac{NechPer}{4}] \cdot AF[0][n] + \sum_{n=0}^{NechSec-1} VF[1][n - \frac{NechPer}{4}] \cdot AF[1][n] + \sum_{n=0}^{NechSec-1} VF[2][n - \frac{NechPer}{4}] \cdot AF[2][n]$$

**Note:** The fundamental power factor is also called the displacement factor.

Total tangent

$$\tan[3] = \frac{Q_1[3]}{P_1[3]}$$

### b) Distribution system with virtual neutral

Total power factor.

$$PF[3] = \frac{P[3]}{S[3]}$$

Total fundamental power factor.

$$DPF[3] = \frac{P_1[3]}{\sqrt{(P_1[3]^2 + Q_1[3]^2)}}$$

With:

$$P_1[3] = \sum_{i=0}^2 \left( \sum_{n=0}^{NechSec-1} VF[i][n] \cdot AF[i][n] \right)$$

$$Q_1[3] = \sum_{i=0}^2 \left( \sum_{n=0}^{NechSec-1} VF[i] \left[ n - \frac{NechPer}{4} \right] \cdot AF[i][n] \right)$$

**Note:** The fundamental power factor is also called the displacement factor.

Total tangent

$$\tan[3] = \frac{Q_1[3]}{QP_1[3]}$$

### c) Three-phase system without neutral

Total power factor

$$PF[3] = \frac{P[3]}{S[3]}$$

Total fundamental power factor

$$DPF[3] = \frac{P_1[3]}{\sqrt{P_1[3]^2 + Q_1[3]^2}}$$

With :

If reference on L1

$$P_1[3] = \frac{1}{NechSec} \cdot \sum_{n=0}^{NechSec-1} U[2][n] \cdot A[2][n] + \frac{1}{NechSec} \cdot \sum_{n=0}^{NechSec-1} -U[0][n] \cdot A[1][n]$$

If reference on L2

$$P_1[3] = \frac{1}{NechSec} \cdot \sum_{n=0}^{NechSec-1} U[0][n] \cdot A[0][n] + \frac{1}{NechSec} \cdot \sum_{n=0}^{NechSec-1} -U[1][n] \cdot A[2][n]$$

If reference on L3

$$P_1[3] = \frac{1}{NechSec} \cdot \sum_{n=0}^{NechSec-1} -U[2][n] \cdot A[0][n] + \frac{1}{NechSec} \cdot \sum_{n=0}^{NechSec-1} U[1][n] \cdot A[1][n]$$

**Note:** The fundamental power factor is also called the displacement factor.

Total tangent

$$\text{Tan}[3] = \frac{Q_1[3]}{P_1[3]}$$

#### d) Two-phase system without neutral

Two-phase distribution systems without neutral (2-wire two-phase) are treated as single-phase distribution system having their voltage reference on L2 rather than N (neutral).

Power factor

$$\text{PF}[0] = \frac{P[0]}{S[0]}$$

Fundamental power factor

$$\text{DPF}[0] = \frac{P_1[0]}{\sqrt{P_1[0]^2 + Q_1[0]^2}}$$

With:

$$P_1[0] = \frac{1}{NechSec} \cdot \sum_{n=0}^{NechSec-1} UF[0][n] \cdot AF[0][n]$$

**Note:** The fundamental power factor is also called the displacement factor.

Tangent

$$\text{Tan}[0] = \frac{Q_1[0]}{P_1[0]}$$

## 16.1.6. ENERGIES

Energies excluding neutral – over Tint with refresh every second

### 16.1.6.1. Distribution system with neutral

**Note:** Tint is the power integration time in energy calculations; the beginning and end of this period are user-controlled.

Consumed DC energy of phase (i+1) with  $i \in [0; 2]$

$$Pdch[0][i] = Wdch[0][i] = \sum_n^{T_{int}} \frac{Pdc[i][n]}{3600} \quad \text{with } Pdc[i][n] \geq 0$$

Total consumed DC energy

$$Pdch[0][3] = Wdch[0][3] = Pdch[0][0] + Pdch[0][1] + Pdch[0][2]$$

#### a) Energies consumed other than DC ( $P[i][n] \geq 0$ )

Consumed active energy of phase (i+1) with  $i \in [0; 2]$ .

$$Ph[0][i] = Wh[0][i] = \sum_n^{T_{int}} \frac{P[i][n]}{3600}$$

Consumed apparent energy of phase (i+1) with  $i \in [0; 2]$ .

$$Sh[0][i] = VAh[0][i] = \sum_n^{T_{int}} \frac{S[i][n]}{3600}$$

Consumed inductive reactive energy of phase (i+1) with  $i \in [0; 2]$ .

(Non-active quantities broken down – Configuration >Calculation methods >VAR)

$$Q_{1hL}[0][i] = VARhL[0][i] = \sum_n^{T_{int}} \frac{Q_1[i][n]}{3600} \quad \text{with } Q_1[i][n] \geq 0$$

Consumed capacitive reactive energy of phase (i+1) with  $i \in [0; 2]$ .

(Non-active quantities broken down – Configuration >Calculation methods >VAR)

$$Q_{1hC}[0][i] = VARhC[0][i] = \sum_n^{T_{int}} \frac{-Q_1[i][n]}{3600} \quad \text{with } Q_1[i][n] < 0$$

Consumed distortion energy of phase (i+1) with  $i \in [0; 2]$

(Non-active quantities broken down – Configuration >Calculation methods >VAR)

$$Dh[0][i] = VADh[0][i] = \sum_n^{T_{int}} \frac{D[i][n]}{3600}$$

Consumed non-active energy of phase (i+1) with  $i \in [0; 2]$

(Non-active quantities not broken down – Configuration >Calculation methods >VAR)

$$Nh[0][i] = VARh[0][i] = \sum_n^{T_{int}} \frac{N[i][n]}{3600}$$

Total consumed active energy

$$Ph[0][3] = Wh[0][3] = Ph[0][0] + Ph[0][1] + Ph[0][2]$$

Total consumed apparent energy

$$Sh[0][3] = VAh[0][3] = Sh[0][0] + Sh[0][1] + Sh[0][2]$$

Total consumed reactive inductive energy

(Non-active quantities broken down – Configuration >Calculation methods >VAR)

$$Q_{1hL}[0][3] = VARhL[0][3] = Q_{1hL}[0][0] + Q_{1hL}[0][1] + Q_{1hL}[0][2]$$

Total consumed capacitive reactive energy

(Non-active quantities broken down – Configuration >Calculation methods >VAR)

$$Q_{,C}[0][3] = VARhC[0][3] = Q_{,C}[0][0] + Q_{,C}[0][1] + Q_{,C}[0][2]$$

Total consumed distortion energy

(Non-active quantities broken down – Configuration >Calculation methods >VAR)

$$Dh[0][3] = VADh[0][3] = Dh[0][0] + Dh[0][1] + Dh[0][2]$$

Total consumed non-active energy

(Non-active quantities not broken down – Configuration >Calculation methods >VAR)

$$Nh[0][3] = VARh[0][3] = Nh[0][0] + Nh[0][1] + Nh[0][2]$$

#### b) Generated DC energy of phase (i+1) with $i \in [0; 2]$

$$Pdch[1][i] = Wdch[1][i] = \sum_n^{T_{int}} \frac{-Pdc[i][n]}{3600} \text{ with } Pdc[i][n] < 0$$

#### c) Total generated DC energy

$$Pdch[1][3] = Wdch[1][3] = Pdch[1][0] + Pdch[1][1] + Pdch[1][2]$$

#### d) Energies generated other than DC ( $P[i][n] < 0$ )

Generated active energy of phase (i+1) with  $i \in [0; 2]$ .

$$Ph[1][i] = Wh[1][i] = \sum_n^{T_{int}} \frac{-P[i][n]}{3600}$$

Generated apparent energy of phase (i+1) with  $i \in [0; 2]$ .

$$Sh[1][i] = VAh[1][i] = \sum_n^{T_{int}} \frac{S[i][n]}{3600}$$

Generated inductive reactive energy of phase (i+1) with  $i \in [0; 2]$ .

(Non-active quantities broken down – Configuration >Calculation methods >VAR)

$$Q_{,hL}[1][i] = VARhL[1][i] = \sum_n^{T_{int}} \frac{-Q_{,i}[i][n]}{3600} \text{ with } Q_{,i}[i][n] < 0$$

Generated capacitive reactive energy of phase (i+1) with  $i \in [0; 2]$ .

(Non-active quantities broken down – Configuration >Calculation methods >VAR)

$$Q_{,hC}[1][i] = VARhC[1][i] = \sum_n^{T_{int}} \frac{Q_{,i}[i][n]}{3600} \text{ with } Q_{,i}[i][n] \geq 0$$

Generated distortion energy of phase (i+1) with  $i \in [0; 2]$

(Non-active quantities broken down – Configuration >Calculation methods >VAR)

$$Dh[1][i] = VADh[1][i] = \sum_n^{T_{int}} \frac{D[i][n]}{3600}$$

Generated non-active energy of phase (i+1) with  $i \in [0; 2]$

(Non-active quantities not broken down – Configuration >Calculation methods >VAR)

$$Nh[1][i] = VARh[1][i] = \sum_n^{T_{int}} \frac{N[i][n]}{3600}$$

Total generated active energy

$$Ph[1][3] = Wh[1][3] = Ph[1][0] + Ph[1][1] + Ph[1][2]$$

Total generated apparent energy

$$Sh[1][3] = VAh[1][3] = Sh[1][0] + Sh[1][1] + Sh[1][2]$$

Total generated inductive reactive energy

(Non-active quantities broken down – Configuration >Calculation methods >VAR)

$$Q_{,hL}[1][3] = VAR_{hL}[1][3] = Q_{,hL}[1][0] + Q_{,hL}[1][1] + Q_{,hL}[1][2]$$

Total generated capacitive reactive energy

(Non-active quantities broken down – Configuration >Calculation methods >VAR)

$$Q_{,hC}[1][3] = VAR_{hC}[1][3] = Q_{,hC}[1][0] + Q_{,hC}[1][1] + Q_{,hC}[1][2]$$

Total generated distortion energy

(Non-active quantities broken down – Configuration >Calculation methods >VAR)

$$Dh[1][3] = VADh[1][3] = Dh[1][0] + Dh[1][1] + Dh[1][2]$$

Total generated non-active energy

(Non-active quantities not broken down – Configuration >Calculation methods >VAR)

$$Nh[1][3] = VAR_{h}[1][3] = Nh[1][0] + Nh[1][1] + Nh[1][2]$$

### 16.1.6.2. Distribution system with virtual neutral or without neutral

We speak here only of total energies, with:

- Three-phase systems without neutral or with virtual neutral:  $i = 3$
- Two-phase system without neutral:  $i = 3$  or  $i = 0$  (this is the same thing - see remark below)

**Note:** Two-phase distribution systems without neutral (2-wire two-phase) are treated as single-phase distribution system having their voltage reference on L2 rather than N (neutral).

Total consumed DC energy

$$Pdch[0][i] = Wdch[0][i] = \sum_n^{T_{int}} \frac{Pdc[i][n]}{3600} \quad \text{with } Pdc[i][n] \geq 0$$

#### a) Total energies consumed other than DC ( $P[i][n] \geq 0$ )

Total consumed active energy

$$Ph[0][i] = Wh[0][i] = \sum_n^{T_{int}} \frac{P[i][n]}{3600}$$

Total consumed apparent energy

$$Sh[0][i] = VAh[0][i] = \sum_n^{T_{int}} \frac{S[i][n]}{3600}$$

Total consumed inductive reactive energy

(Non-active quantities broken down – Configuration >Calculation methods >VAR)

$$Q_{,hL}[0][i] = VAR_{hL}[0][i] = \sum_n^{T_{int}} \frac{Q_1[i][n]}{3600} \quad \text{with } Q_1[i][n] \geq 0$$

Total consumed capacitive reactive energy

(Non-active quantities broken down – Configuration >Calculation methods >VAR)

$$Q_{,hC}[0][i] = VAR_{hC}[0][i] = \sum_n^{T_{int}} \frac{-Q_1[i][n]}{3600} \quad \text{with } Q_1[i][n] < 0$$

Total consumed distortion energy

(Non-active quantities broken down – Configuration >Calculation methods >VAR)

$$Dh[0][i] = VADh[0][i] = \sum_n^{T_{int}} \frac{D[i][n]}{3600}$$

Total consumed non-active energy

(Non-active quantities not broken down – Configuration >Calculation methods >VAR)

$$N_h[0][i] = VAR_h[0][i] = \sum_n^{T_{int}} \frac{N[i][n]}{3600}$$

**b) Total generated DC energy**

$$P_{dch}[1][i] = W_{dch}[1][i] = \sum_n^{T_{int}} \frac{-P_{dc}[i][n]}{3600} \quad \text{with } P_{dc}[i][n] < 0$$

**c) Total energies generated other than DC ( $P[i][n] < 0$ )**

Total generated active energy

$$P_h[1][i] = W_h[1][i] = \sum_n^{T_{int}} \frac{-P[i][n]}{3600}$$

Total generated apparent energy

$$S_h[1][i] = VA_h[1][i] = \sum_n^{T_{int}} \frac{S[i][n]}{3600}$$

Total generated inductive reactive energy

(Non-active quantities broken down – Configuration >Calculation methods >VAR)

$$Q_{1hL}[1][i] = VAR_{hL}[1][i] = \sum_n^{T_{int}} \frac{-Q_1[i][n]}{3600} \quad \text{with } Q_1[i][n] < 0$$

Total generated capacitive reactive energy

(Non-active quantities broken down – Configuration >Calculation methods >VAR)

$$Q_{1hC}[1][i] = VAR_{hC}[1][i] = \sum_n^{T_{int}} \frac{Q_1[i][n]}{3600} \quad \text{with } Q_1[i][n] \geq 0$$

Total generated distortion energy

(Non-active quantities broken down – Configuration >Calculation methods >VAR)

$$D_h[1][i] = VAD_h[1][i] = \sum_n^{T_{int}} \frac{D[i][n]}{3600}$$

Total generated non-active energy

(Non-active quantities not broken down – Configuration >Calculation methods >VAR)

$$N_h[1][i] = VAR_h[1][i] = \sum_n^{T_{int}} \frac{N[i][n]}{3600}$$

## 16.2. DISTRIBUTION SOURCES SUPPORTED BY THE DEVICE

See connections in §4.6.

## 16.3. HYSTERESIS

Hysteresis is a screening principle that is often used after detection of a threshold stage in  $\triangle$  Alarm mode (see §4.10) and in Inrush current mode (see §5.2). A correct hysteresis setting avoids repeated changes of state when the measurement oscillates about the threshold.

### 16.3.1. SURGE DETECTION

With a hysteresis of 2%, for example, the return level for surge detection is equal to  $(100\% - 2\%)$  or 98% of the voltage threshold.

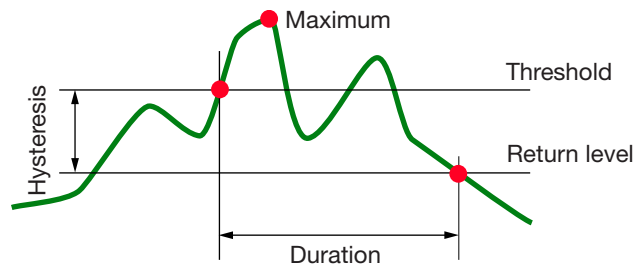

### 16.3.2. BROWNOUT OR BLACKOUT DETECTION

With a hysteresis of 2%, for example, the return level for brownout detection is equal to  $(100\% + 2\%)$ , or 102% of the voltage threshold.

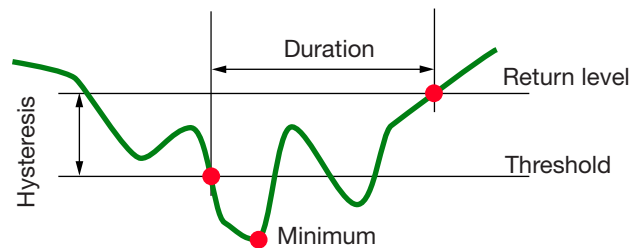

## 16.4. MINIMUM SCALE VALUES FOR WAVEFORMS AND MINIMUM RMS VALUES

	Minimum scale value (waveform mode)	Minimum RMS values
Phase-to-neutral and phase-to-phase voltages	8 V <sup>(1)</sup>	2 V <sup>(1)</sup>
AmpFLEX™ A193 (6500 A and 10 kA)	90 A	10 A
MiniFLEX MA193 (6500 A et 10 kA)	90 A	10 A
AmpFLEX™ A193 (100 A)	800 mA	100 mA
MiniFLEX MA193 (100 A)	800 mA	100 mA
J93 clamp	30 A	3 A
C193 clamp	8 A	1 A
PAC93 clamp	8 A	1 A
MN93 clamp	2 A	200 mA
MN93A clamp (100 A)	800 mA	100 mA
E3N clamp (10 mV/A)	800 mA	100 mA
E3N clamp (100 mV/A)	80 mA	10 mA
MN93A clamp (5 A)	40 mA <sup>(1)</sup>	5 mA <sup>(1)</sup>
5 A and Essailec® adapter	40 mA <sup>(1)</sup>	5 mA <sup>(1)</sup>

(1) Value to be multiplied by the ratio in effect (if not unity).



## 16.5. FOUR-QUADRANT DIAGRAM

This diagram is used for **W** power and energy measurements (see §9).

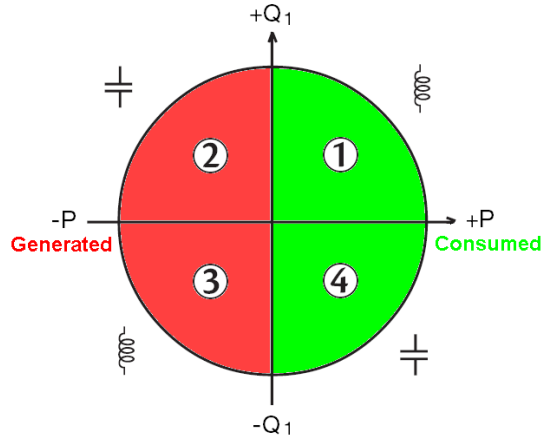
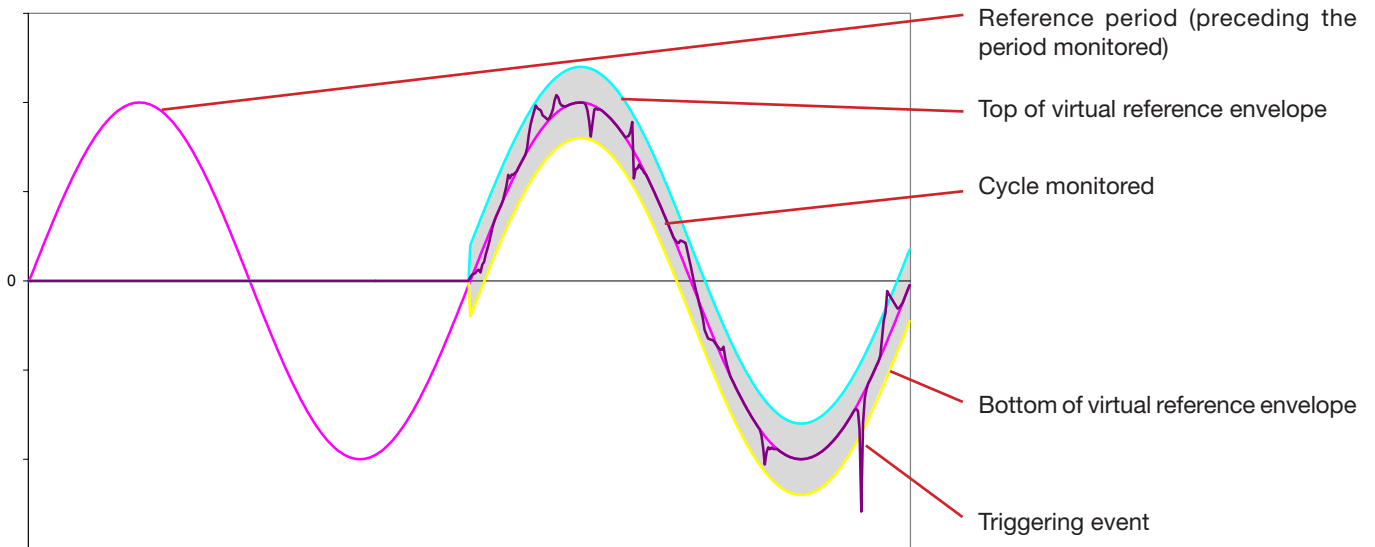

Figure 123: Four-quadrant diagram

## 16.6. MECHANISM FOR TRIGGERING TRANSIENT CAPTURES

The sampling rate is a constant 256 samples per cycle. When a transient capture is started, each sample is compared to the sample from the preceding cycle. The preceding cycle defines the mid-point of a virtual tube and is used as reference. As soon as a sample is outside the envelope, it is treated as a triggering event; the representation of the transient is then captured by the device. The cycle preceding the event and the three following cycles are saved to memory.

Here is a graphic representation of the transient capture triggering mechanism:



The half-width of the virtual envelope for the voltage and current is equal to the threshold programmed in the Transient mode of the configuration (see §4.8).

## 16.7. CAPTURE CONDITIONS IN INRUSH CURRENT MODE

The capture depends on a triggering (start) event and a stop event. If a capture ends with a stop event or if the recording memory of the device is full, the capture stops automatically.

The capture stop threshold is calculated as follows:

$$[\text{Stop threshold [A]}] = [\text{Start threshold [A]}] \times (100 - [\text{stop hysteresis [\%]}]) \div 100$$

Here are the conditions for triggering and stopping captures:

Triggering filter	Triggering and stop conditions
A1	Triggering condition $\Leftrightarrow$ [A1 half-cycle RMS value] > [Triggering threshold] Stop condition $\Leftrightarrow$ [A1 half-cycle RMS value] < [Stop threshold]
A2	Triggering condition $\Leftrightarrow$ [A2 half-cycle RMS value] > [Triggering threshold] Stop condition $\Leftrightarrow$ [A2 half-cycle RMS value] < [Stop threshold]
A3	Triggering condition $\Leftrightarrow$ [A3 half-cycle RMS value] > [Triggering threshold] Stop condition $\Leftrightarrow$ [A3 half-cycle RMS value] < [Stop threshold]
3A	Triggering condition $\Leftrightarrow$ [[the half-cycle RMS value of one current channel] > [Triggering threshold] Stop condition $\Leftrightarrow$ [the half-cycle RMS values of all current channels] < [Stop threshold]

## 16.8. GLOSSARY

$\simeq$	AC and DC components.
$\sim$	AC component only.
$\equiv$	DC component only.
$\overset{ }{\sim}$	Inductive phase shift.
$\overset{=}{\sim}$	Capacitive phase shift.
$^{\circ}$	Degree.
-.+	Expert mode.
	Absolute value.
$\Phi_{VA}$	Phase shift of the phase-to-neutral (phase voltage) voltage with respect to the phase-to-neutral current (line current).
$\Phi_{UA}$	Phase shift of the voltage phase-to-phase (line voltage) with respect to the phase-to-neutral current (line current). Two-wire two-phase mode only.
$\Sigma$	Value of the system.
%	Percentage.
%f	Fundamental value as reference (percentage of the fundamental).
%r	Total value as reference (percentage of the total value).
<b>A</b>	Phase-to-ground current (line current) or the unit “ampere”.
<b>A-h</b>	Harmonic in current.
<b>Acf</b>	Peak factor of the current.
<b>Ad</b>	RMS distortion current.
<b>Adc</b>	DC current.
<b>Apk+</b>	Maximum peak value of the current.
<b>Apk-</b>	Minimum peak value of the current.
<b>Arms</b>	RMS current.
<b>Athd</b>	Total harmonic distortion of the current.
<b>Athdf</b>	Harmonic distortion of the current with the RMS value of the fundamental as reference.
<b>Athdr</b>	Harmonic distortion of the current with the total RMS value without DC as reference.
<b>Aunb</b>	Negative-sequence current unbalance rate.
<b>AVG</b>	Mean value (arithmetic mean).
<b>Blackout:</b>	fall of voltage, at some point in the power network, to below a specified threshold.
<b>BTU</b>	British Thermal Unit.
<b>CF</b>	Peak factor (Crest Factor) in current or voltage: ratio of the peak value of a signal to the RMS value.
<b>Channel and phase:</b>	a measurement channel corresponds to a difference in potential between two conductors. A phase is a single conductor. In polyphased systems, a measurement channel may be between two phases, or between a phase and neutral, or between a phase and earth, or between neutral and earth.
<b>cos <math>\Phi</math></b>	Cosine of the phase shift of the voltage with respect to the current (displacement factor – DPF).
<b>D</b>	Distortion power.
<b>Dip threshold:</b>	specific voltage used to define the beginning and end of a voltage dip.
<b>DC</b>	DC component (current or voltage).
<b>Dh</b>	Distortion energy.

<b>DPF</b>	Displacement factor ( $\cos \Phi$ ).
<b>E</b>	Exa ( $10^{18}$ )
<b>FK</b>	K factor. Used to quantify the effect of a load on a transformer.
<b>FHL</b>	Harmonic loss factor.
<b>Flicker</b>	a visual effect of voltage variations.
<b>Frequency</b>	number of full voltage or current cycles in one second.
<b>Fundamental component:</b>	component at the fundamental frequency.
<b>G</b>	Giga ( $10^9$ )
<b>Harmonics</b>	in electrical systems, voltages and currents at frequencies that are multiples of the fundamental frequency.
<b>Hysteresis</b>	difference between thresholds for reciprocal changes of state.
<b>Hz</b>	Frequency of the network.
<b>J</b>	Joule
<b>k</b>	kilo ( $10^3$ )
<b>L</b>	Channel (Line).
<b>m</b>	milli ( $10^{-3}$ )
<b>ms</b>	millisecond.
<b>M</b>	Mega ( $10^6$ )
<b>MAX</b>	Maximum value.
<b>MIN</b>	Minimum value.
<b>N</b>	Non-active power.
<b>Nh</b>	Non-active energy.
<b>Nominal voltage:</b>	Reference voltage of a network.
<b>non-nuclear toe:</b>	non-nuclear tonne oil equivalent.
<b>nuclear toe:</b>	nuclear tonne oil equivalent.
<b>Order of a harmonic:</b>	ratio of the frequency of the harmonic to the fundamental frequency; a whole number.
<b>P</b>	Peta ( $10^{15}$ )
<b>P</b>	Active power.
<b>Passband</b>	range of frequencies in which the response of a device exceeds some specified minimum.
<b>Pdc</b>	DC power.
<b>Pdch</b>	DC energy.
<b>PF</b>	Power Factor: ratio of active power to apparent power.
<b>Ph</b>	Active energy.
<b>Phase</b>	temporal relationship between current and voltage in alternating current circuits.
<b>PK</b>	or PEAK. Maximum (+) or minimum (-) peak value of the signal.
<b>PLT</b>	Long-term severity. The device calculates its PLT over 2 hours.
<b>PST</b>	Short-term severity. The device calculates its PST over 10 minutes.
<b><math>Q_r</math></b>	Reactive power.
<b><math>Q_r h</math></b>	Reactive energy.
<b>RMS</b>	RMS (Root Mean Square) value of current or voltage. Square root of the mean of the squares of the instantaneous values of a quantity during a specified interval.
<b>S</b>	Apparent power.
<b>S-h</b>	Harmonics in power.
<b>Sh</b>	Apparent energy.
<b>Temporary surge at industrial frequency:</b>	temporary increase in voltage at some point in the power network, to above a specified threshold.
<b>t</b>	Relative date of the Time cursor.
<b>T</b>	Tera ( $10^{12}$ )
<b><math>\tan \Phi</math></b>	Tangent of the phase shift of the voltage with respect to the current.
<b>toe</b>	Tonne oil equivalent (nuclear or non-nuclear).
<b>THD</b>	Total Harmonic Distortion. The total harmonic distortion represents the proportion of the harmonics of a signal with respect to the fundamental RMS value (%f) or with respect to the total RMS value without DC (%r).
<b>U</b>	Phase-to-phase voltage (line voltage).
<b>U-h</b>	Harmonics in phase-to-phase voltage (line voltage).
<b>Ucf</b>	Peak factor of the phase-to-phase voltage (line voltage).

<b>Ud</b>	Phase-to-phase RMS distortion voltage (line voltage).
<b>Udc</b>	Phase-to-phase DC voltage (line voltage).
<b>Uh</b>	Harmonic of the phase-to-phase voltage (line voltage).
<b>Upk+</b>	Maximum peak value of phase-to-phase voltage (line voltage).
<b>Upk-</b>	Minimum peak value of phase-to-phase voltage (line voltage).
<b>Urms</b>	Phase-to-phase RMS voltage (line voltage).
<b>Uthd</b>	Total harmonic distortion of the phase-to-phase voltage (line voltage).
<b>Uthdf</b>	Harmonic distortion of the phase-to-phase voltage (line voltage) with the RMS value of the fundamental as reference.
<b>Uthdr</b>	Harmonic distortion of the phase-to-phase voltage (line voltage) with the total RMS value without DC as reference.
<b>Uunb</b>	Negative-sequence unbalance rate in phase-to-phase voltage (line voltage).
<b>V</b>	Phase-to-neutral voltage or the unit "volt".
<b>V-h</b>	Harmonics in phase-to-neutral voltage (phase voltage).
<b>Vcf</b>	Peak factor of the phase-to-neutral voltage (phase voltage).
<b>Vd</b>	Phase-to-neutral RMS distortion voltage (phase voltage).
<b>Vdc</b>	Phase-to-neutral DC voltage (phase voltage).
<b>Vpk+</b>	Maximum peak value of the phase-to-neutral voltage (phase voltage).
<b>Vpk-</b>	Minimum peak value of the phase-to-neutral voltage (phase voltage).
<b>Vh</b>	Harmonic of the phase-to-neutral voltage (phase voltage).
<b>Voltage dip:</b>	temporary fall of voltage, at some point in the power network, to below a specified threshold.
<b>Voltage unbalance in a polyphased electric power network:</b>	state in which the RMS voltages between conductors (fundamental component) and/or the phase differences between successive conductors are not all equal.
<b>Vrms</b>	RMS phase-to-neutral voltage (phase voltage).
<b>Vthd</b>	Total harmonic distortion of phase-to-neutral voltage (phase voltage).
<b>Vthdf</b>	Total harmonic distortion of phase-to-neutral voltage (phase voltage) with the fundamental RMS value as reference.
<b>Vthdr</b>	Total harmonic distortion of phase-to-neutral voltage (phase voltage) with the total RMS value without DC as reference.
<b>Vunb</b>	Negative-sequence unbalance rate in phase-to-neutral voltage (phase voltage).
<b>Wh</b>	Watt-hour.

## 17. MAINTENANCE

⚠ Except for the battery and the memory card, the instrument contains no parts that can be replaced by personnel who have not been specially trained and accredited. Any unauthorized repair or replacement of a part by an “equivalent” may gravely impair safety.

### 17.1. CLEANING THE CASING

Disconnect the unit completely and switch it OFF.

Use a soft cloth, dampened with soapy water. Rinse with a damp cloth and dry rapidly with a dry cloth or forced air. Do not use alcohol, solvents, or hydrocarbons.

### 17.2. MAINTENANCE OF SENSORS

Current sensors must be maintained and calibrated as follows:

- Clean with a sponge and soapy water, rinse with a sponge and clean water, and dry rapidly.
- Keep the air gaps of the clamps (MN93, MN93A, C193, PAC93 and E3N) perfectly clean using a cloth. Lightly oil visible metal parts to avoid rust.

### 17.3. REPLACING THE BATTERY

⚠ For safety reasons, replace the battery only with the original model (see §19.3).

- **Do not throw the battery into a fire.**
- **Do not expose the battery to a temperature in excess of 100°C.**
- **Do not short-circuit the terminals of the battery pack.**

**Remove the old battery.**

- ⚠ To eliminate all risk of electric shock, disconnect the power supply cord and measurement leads of the device.
- Turn the device over, raise the stand, and prop it up against the small yellow stops.
- Use a coin to unscrew the two quarter-turn screws on the back of the housing.

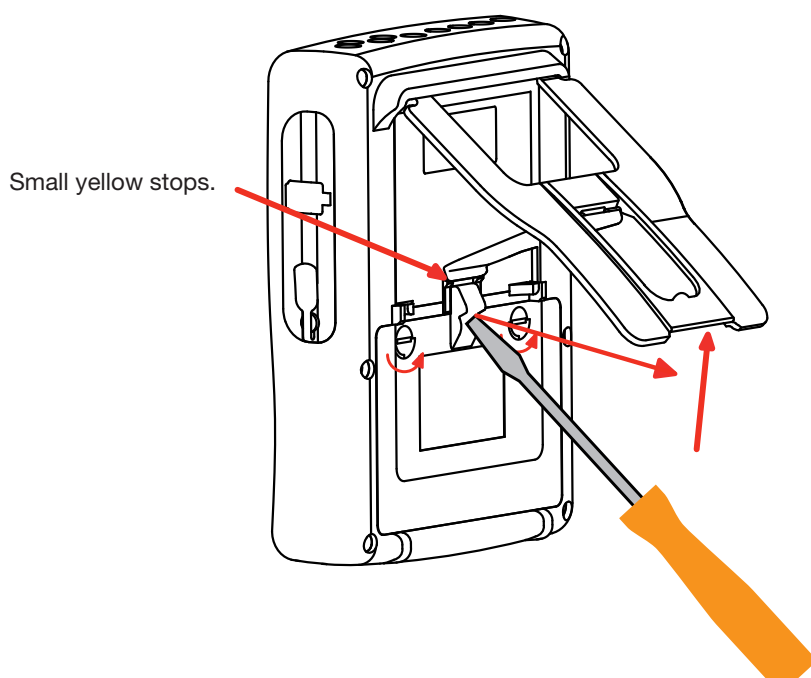

- Using a flat screwdriver, remove the cover from the compartment.

- Turn the device over and hold the battery as it slides out of its compartment.
- Disconnect the battery connector without pulling on the wires.

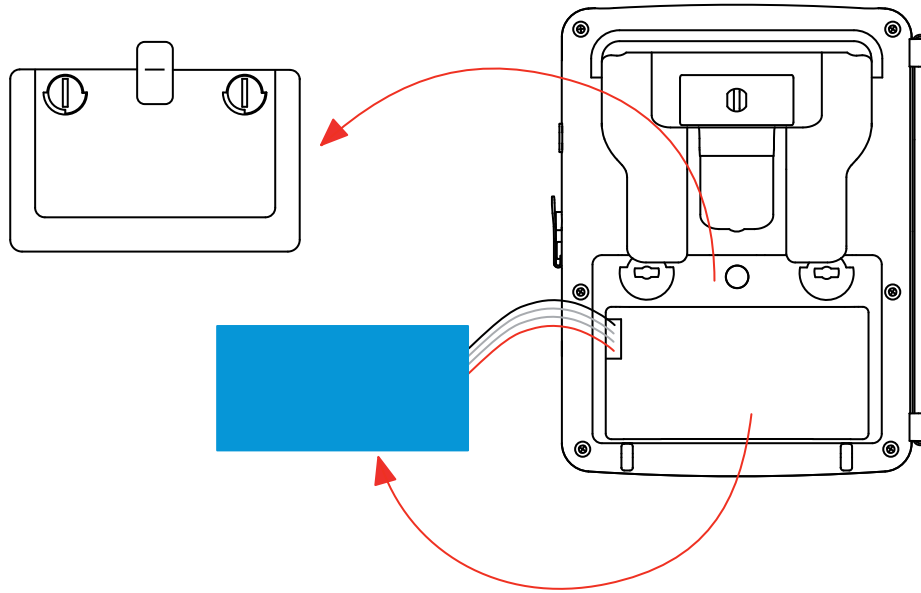

**Note:** The Qualistar+ preserves the date-time function for approximately 4 hours without the battery.  
The Qualistar+ preserves an inrush current capture for approximately 2 hours without its battery.

 Spent batteries must not be treated as ordinary household waste. Take them to the appropriate recycling collection point.

#### Fitting the new battery.

- Connect the new battery. The connector is error-proofed to prevent reversals of polarity.
- Place the battery in its compartment and arrange the wires so that they do not protrude.
- Put the battery compartment cover back in place and screw the 2 quarter-turn screws back in.

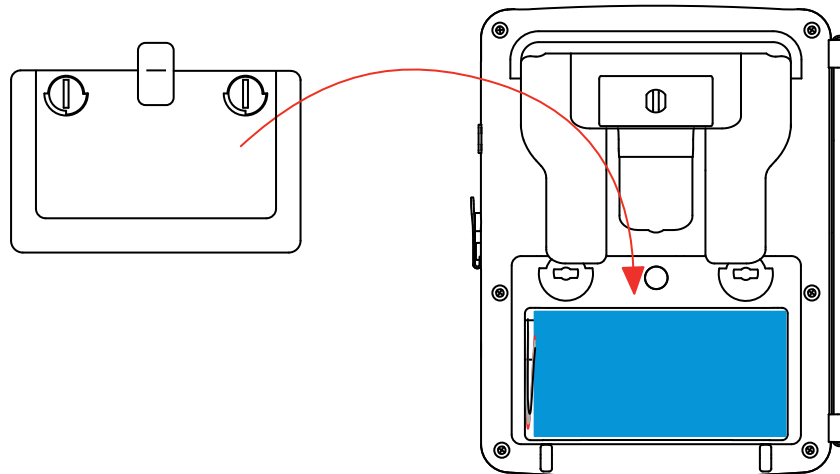

**Warning:** If the battery is disconnected, it must then be fully recharged, even if it is not replaced, so that the device will know the battery charge condition (this information is lost when the battery is disconnected).

## 17.4. REPLACING THE SCREEN FILM

Proceed as follows to replace the screen film of the device:

- Remove the old screen film.
- Remove the protection plastic film from the new screen film using the white tab.
- Place the adhesive side of the film against the screen of the device. Smooth the film with a clean cloth to remove any air bubbles.

## 17.5. MEMORY CARD

The device accepts SD (SDSC), SDHC, and SDXC type memory cards.

Before withdrawing or inserting the memory card, make sure that the device is disconnected and off. Write-protect the memory card when you withdraw it from the device. Cancel the write protection before putting the card back into its space in the device.



To withdraw the memory card from its space, proceed as for the replacement of the battery, described in §17.3. Once the battery has been withdrawn from its compartment, push the tab out of the way, then push the memory card out of the device.

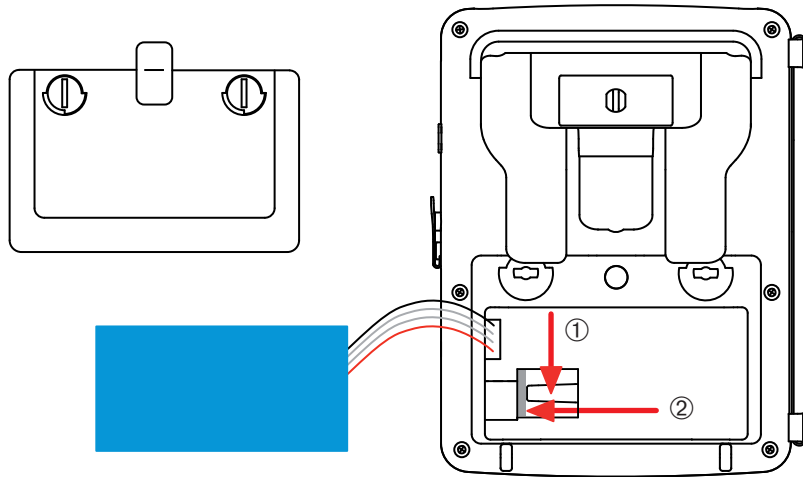

To put the card back in place, slide it horizontally into its space until it is home and the tab is back in position. Then replace the battery and the battery compartment cover as explained in §17.3.

## 17.6. METROLOGICAL CHECK

**⚠ Like all measuring or testing devices, the instrument must be checked regularly.**

This instrument should be checked at least once a year. For checking and calibration, contact one of our accredited metrology laboratories (information and contact details available on request), at our Chauvin Arnoux subsidiary or the branch in your country.

**Note:** From the first check of the device, the Information sub-menu of the Configuration menu displays the date of adjustment and the date of the next adjustment, as in the example below:

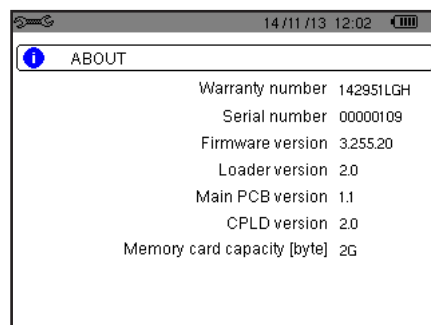

Figure 36: the About menu

## 17.7. REPAIR

For all repairs before or after expiry of warranty, please return the device to your distributor.

## 17.8. UPDATING OF THE INTERNAL SOFTWARE

With a view to providing, at all times, the best possible service in terms of performance and technical upgrades, Chauvin Arnoux invites you to update the embedded software of the device by downloading the new version, available free of charge on our web site.

Our site:

[www.chauvin-arnoux.com](http://www.chauvin-arnoux.com)

In "Support", click on "Download our software" and enter the name of the instrument "C.A 8336".

Connect the device to your PC using the type A-B USB cord provided.

The embedded software update requires compatibility with the hardware version of the device, indicated in the *About* sub-menu of the *Configuration* menu (see figure 36 above).

**Warning:** the update of the embedded software erases all data (configuration, alarm campaigns, snapshots, inrush current capture, transient detection, trend recordings. Save any data you want to keep to a PC using the PAT2 software (see §13) before updating the embedded software.

# 18. WARRANTY

---

Except as otherwise stated, our warranty is valid for **three years** starting from the date on which the equipment was sold. Extract from our General Conditions of Sale provided on request.

The warranty does not apply in the following cases:

- Inappropriate use of the equipment or use with incompatible equipment;
- Modifications made to the equipment without the explicit permission of the manufacturer's technical staff;
- Work done on the device by a person not approved by the manufacturer;
- Adaptation to a particular application not anticipated in the definition of the equipment or not indicated in the user's manual;
- Damage caused by shocks, falls, or floods.



## 19. TO ORDER

### 19.1. C.A 8336 THREE-PHASE ELECTRICAL NETWORKS ANALYSER

**C.A 8336 without clamp ..... P01160591**

The device is delivered with:

- 1 no. 22 shoulder bag
- 5 black straight-straight safety cables 3 m long attached with a Velcro tie.
- 5 black crocodile clips.
- 1 specific PA 30W mains power unit with mains cord.
- 1 set of 12 inserts and rings to identify voltage phases and leads and current phases and leads.
- 1 USB A/B cord, 1.80m long, with ferrite.
- 1 Power Analyser Transfer (PAT2) software.
- 1 checking attestation.
- user's manuals on CD (one per language)
- multilingual safety sheets.

### 19.2. ACCESSORIES

5 A adapter (three-phase) .....	P01101959
Essailec® 5A adapter (three-phase) .....	P01102131
MN93 clamp .....	P01120425B
MN93A clamp .....	P01120434B
PAC93 clamp .....	P01120079B
C193 clamp .....	P01120323B
AmpFLEX™ A193 450 mm .....	P01120526B
AmpFLEX™ A193 800 mm .....	P01120531B
MiniFLEX MA193 250 mm .....	P01120580
MiniFLEX MA193 350 mm .....	P01120567
E3N clamp .....	P01120043A
E3N clamp adapter .....	P01102081
Mains power unit + E3N clamp .....	P01120047
Dataview software .....	P01102095

### 19.3. SPARE PARTS

9.6 V 4 Ah NiMH battery pack .....	P01296024
USB-A USB-B cord .....	P01295293
PA30W mains power unit .....	P01102057
Screen protection film .....	P01102059
No. 22 carrying bag.....	P01298056
No. 21 carrying bag.....	P01298055
Set of 5 black banana-banana straight-straight safety cables, 5 black crocodile clips and 12 inserts and rings to identify phases, voltage leads and current sensors .....	P01295483
Set of 12 inserts and rings to identify voltage phases and leads and current phases and leads .....	P01102080



03 - 2016

Code 694060A02 - Ed. 5

**DEUTSCHLAND - Chauvin Arnoux GmbH**

Ohmstraße1 - 77694 Kehl / Rhein  
Tel: (07851) 99 26-0 - Fax: (07851) 99 26-60

**UNITED KINGDOM - Chauvin Arnoux Ltd**

Unit 1 Nelson Ct - Flagship Sq - Shaw Cross Business Pk  
Dewsbury, West Yorkshire - WF12 7TH  
Tel: 01924 460 494 - Fax: 01924 455 328

**ITALIA - Amra SpA**

Via Sant'Ambrogio, 23/25 - 20846 Macherio (MB)  
Tel: 039 245 75 45 - Fax: 039 481 561

**ÖSTERREICH - Chauvin Arnoux Ges.m.b.H**

Slamastrasse 29/2/4 - 1230 Wien  
Tel: 01 61 61 9 61-0 - Fax: 01 61 61 9 61-61

**SCANDINAVIA - CA Mätssystem AB**

Sjöflygvägen 35 - SE 18304 TÄBY  
Tel: +46 8 50 52 68 00 - Fax: +46 8 50 52 68 10

**SCHWEIZ - Chauvin Arnoux AG**

Moosacherstrasse 15 - 8804 AU / ZH  
Tel: 044 727 75 55 - Fax: 044 727 75 56

**中国 - 上海浦江埃纳迪斯仪表有限公司**

上海市虹口区祥德路381号3号楼3楼  
Tel: +86 21 65 21 51 96 - Fax: +86 21 65 21 61 07

**ESPAÑA - Chauvin Arnoux Ibérica S.A.**

C/ Roger de Flor, 293 - 1a Planta - 08025 Barcelona  
Tel: 90 220 22 26 - Fax: 93 459 14 43

**MIDDLE EAST - Chauvin Arnoux Middle East**

P.O. BOX 60-154 - 1241 2020 JAL EL DIB (Beirut) - LEBANON  
Tel: (01) 890 425 - Fax: (01) 890 424

**USA - Chauvin Arnoux Inc - d.b.a AEMC Instruments**

200 Foxborough Blvd. - Foxborough - MA 02035  
Tel: (508) 698-2115 - Fax: (508) 698-2118

<http://www.chauvin-arnoux.com>

190, rue Championnet - 75876 PARIS Cedex 18 - FRANCE

Tél. : +33 1 44 85 44 85 - Fax : +33 1 46 27 73 89 - info@chauvin-arnoux.fr

Export : Tél. : +33 1 44 85 44 38 - Fax : +33 1 46 27 95 59 - export@chauvin-arnoux.fr