

## P/N: T199590

### Copyright

© 2019, FLIR Systems, Inc.

All rights reserved worldwide. Names and marks appearing herein are either registered trademarks or trademarks of FLIR Systems and/or its subsidiaries. All other trademarks, trade names or company names referenced herein are used for identification only and are the property of their respective owners.

### Document identity

Publ. No.: T199590

Commit: 54875

Language:

Modified: 2019-01-21

Formatted: 2019-09-04

### Website

<http://www.flir.com>

### Customer support

<http://support.flir.com>

### Disclaimer

Specifications subject to change without further notice. Camera models and accessories subject to regional market considerations. License procedures may apply. Products described herein may be subject to US Export Regulations. Please refer to [exportquestions@flir.com](mailto:exportquestions@flir.com) with any questions.



Imaging and optical data	
Field of view (FOV)	42° × 32°
Minimum focus distance	0.15 m (0.49 ft.)
Minimum focus distance with MSX	0.65 m (2.13 ft.)
Focal length	10 mm (0.39 in.)
Spatial resolution (IFOV)	2.41 mrad/pixel
Lens identification	Yes, AutoCal
F-number	1.1
Measurement	
Accuracy	±3°C (±5.4°F) or ±3% of reading, for ambient temperature 15–35°C (59–95°F) and object temperature above 0°C (32°F).
Physical data	
Weight	0.140 kg (0.31 lb.)
Size (L × D)	45.4 × 72 mm (1.79 × 2.83 in.)
Shipping information	
Packaging, type	Cardboard box
List of contents	<ul style="list-style-type: none"> <li>• Lens</li> <li>• Lens case</li> </ul>
Packaging, weight	0.410 kg (0.90 lb.)
Packaging, size	151 × 125 × 125 mm (5.9 × 4.9 × 4.9 in.)
EAN-13	4743254003118
UPC-12	845188014513
Country of origin	Sweden and/or Estonia

### Compatible with the following products:

- 82501-0201; FLIR T840 14°
- 82502-0201; FLIR T840 24°
- 82504-0201; FLIR T840 24° + 14°
- 82506-0201; FLIR T840 24° + 14° & 42°
- 82505-0201; FLIR T840 24° + 42°
- 82503-0201; FLIR T840 42°
- 82507-0201; FLIR T840 42° + 14°
- 89201-0101; FLIR T860 14°



## Lens 42° + case

P/N: T199590

© 2019, FLIR Systems, Inc.

#T199590; r. 54875;

- 89202-0101; FLIR T860 24°
- 89204-0101; FLIR T860 24° + 14°
- 89206-0101; FLIR T860 24° + 14° & 42°
- 89205-0101; FLIR T860 24° + 42°
- 89203-0101; FLIR T860 42°
- 89207-0101; FLIR T860 42° + 14°
- 79301-0101; FLIR T530 14°
- 79302-0101; FLIR T530 24°
- 79304-0101; FLIR T530 24° + 14°
- 79306-0101; FLIR T530 24° + 14° & 42°
- 79305-0101; FLIR T530 24° + 42°
- 79303-0101; FLIR T530 42°
- 79307-0101; FLIR T530 42° + 14°
- 79301-0201; FLIR T540 14°
- 79302-0201; FLIR T540 24°
- 79304-0201; FLIR T540 24° + 14°
- 79306-0201; FLIR T540 24° + 14° & 42°
- 79305-0201; FLIR T540 24° + 42°
- 79303-0201; FLIR T540 42°
- 79307-0201; FLIR T540 42° + 14°
- 78501-0101; FLIR E75 14°
- 78502-0101; FLIR E75 24°
- 78504-0101; FLIR E75 24° + 14°
- 78506-0101; FLIR E75 24° + 14° & 42°
- 78505-0101; FLIR E75 24° + 42°
- 78503-0101; FLIR E75 42°
- 78507-0101; FLIR E75 42° + 14°
- 78501-0201; FLIR E85 14°
- 78502-0201; FLIR E85 24°
- 78504-0201; FLIR E85 24° + 14°
- 78506-0201; FLIR E85 24° + 14° & 42°
- 78505-0201; FLIR E85 24° + 42°
- 78503-0201; FLIR E85 42°
- 78507-0201; FLIR E85 42° + 14°
- 78501-0301; FLIR E95 14°
- 78502-0301; FLIR E95 24°
- 78504-0301; FLIR E95 24° + 14°
- 78506-0301; FLIR E95 24° + 14° & 42°
- 78505-0301; FLIR E95 24° + 42°
- 78503-0301; FLIR E95 42°
- 78507-0301; FLIR E95 42° + 14°

Lens IR f=10mm (42°)

Lens IR f=17mm (24°)

Lens IR f=29mm (14°)

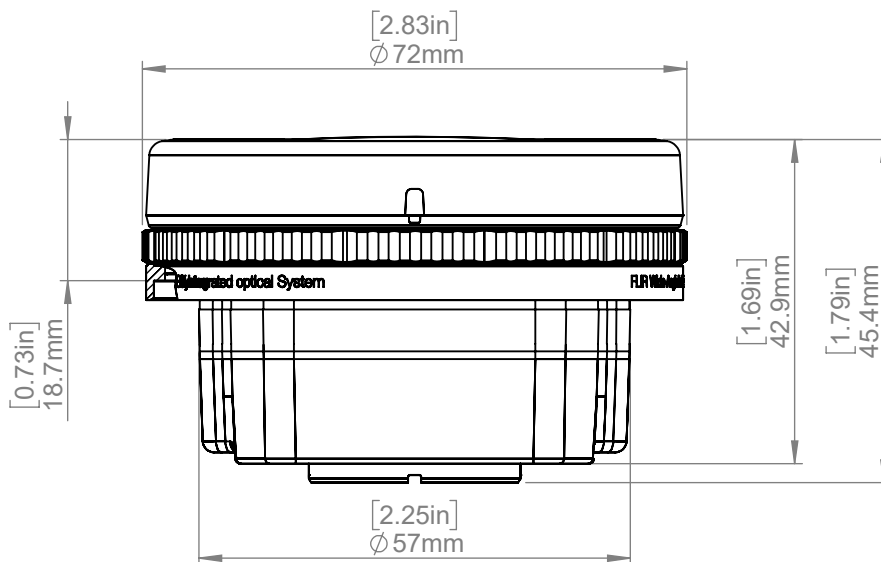

© 2016, FLIR Systems, Inc. All rights reserved worldwide. No part of this drawing may be reproduced, stored in a retrieval system, or transmitted in any form, or by any means, electronic, mechanical, photocopying, recording, or otherwise, without written permission from FLIR Systems, Inc. Specifications subject to change without further notice. Dimensional data is based on nominal values. Products may be subject to regional market considerations. License procedures may apply. Product may be subject to US Export Regulations. Please refer to exportquestions@flir.com with any questions. Diversion contrary to US law is prohibited.

Modified 2017-05-10	Check AKZE	Drawn by R&D Instruments			
Denomination				Size A4	
Basic dimensions for lenses T199104, T199105, T199106			Scale 1:1		Sheet 1(1)
			Drawing No. T130322	Rev A	