



TeraOhmXA 5 kV
MI 3205
Instruction manual
Version 1.2.2; Code No. 20 752 446

Distributor:

Manufacturer:

METREL d.d.
Ljubljanska cesta 77
1354 Horjul
Slovenia
web site: <http://www.metrel.si>
e-mail: metrel@metrel.si



Mark on your equipment certifies that this equipment meets the requirements of the EU (European Union) concerning safety and electromagnetic compatibility regulations

© 2015 METREL

No part of this publication may be reproduced or utilized in any form or by any means without permission in writing from METREL.

Table of contents

| | | |
|----------|---|-----------|
| 1 | General Description..... | 5 |
| 1.1 | Features | 5 |
| 2 | Safety and operational considerations | 6 |
| 2.1 | Warnings and notes..... | 6 |
| 2.2 | Battery and charging of Li-ion battery pack..... | 8 |
| 2.2.1 | Precharge..... | 9 |
| 2.2.2 | Li – ion battery pack guidelines..... | 11 |
| 2.3 | Standards applied..... | 12 |
| 3 | Instrument description | 13 |
| 3.1 | Instrument casing | 13 |
| 3.2 | Operator’s panel | 13 |
| 3.3 | Accessories | 15 |
| 3.3.1 | Test leads..... | 15 |
| 3.4 | Display organization | 16 |
| 3.4.1 | Measurement result window | 16 |
| 3.4.2 | Measurement control window | 17 |
| 3.4.3 | Message window | 18 |
| 3.4.4 | Battery, time and communication indication..... | 19 |
| 3.4.5 | Measurement result line | 20 |
| 3.4.6 | Graphical presentation of measured data | 20 |
| 3.4.7 | Backlight operation | 20 |
| 4 | Main menu..... | 21 |
| 4.1 | Instrument Main menu | 21 |
| 4.2 | Custom tests | 22 |
| 4.2.1 | Creating custom test..... | 22 |
| 4.3 | Memory menu..... | 23 |
| 4.3.1 | Saving results..... | 23 |
| 4.3.2 | Recalling results | 24 |
| 4.3.3 | Deleting results..... | 25 |
| 4.3.4 | Deleting custom test..... | 25 |
| 4.3.5 | Clearing complete memory content | 26 |
| 4.4 | Settings menu | 26 |
| 4.4.1 | Language selection | 27 |
| 4.4.2 | Initial Settings selection | 27 |
| 4.4.3 | Time selection | 27 |
| 4.4.4 | Date selection..... | 27 |
| 4.4.5 | Transfer mode | 28 |
| 4.4.6 | Contrast selection..... | 28 |
| 4.4.7 | Warning sound | 28 |
| 4.4.8 | Graph selection | 28 |
| 4.4.9 | Break Down selection..... | 29 |
| 4.4.10 | Instrument info..... | 29 |
| 4.5 | Help Menu | 29 |
| 5 | Measurements..... | 30 |
| 5.1 | General information about high voltage testing..... | 30 |
| 5.1.1 | The purpose of insulation tests | 30 |
| 5.1.2 | DC vs. AC testing voltage | 30 |

| | | |
|--|--|-----------|
| 5.1.3 | Typical insulation tests | 30 |
| 5.1.4 | Electrical representation of insulating material | 31 |
| 5.2 | Some application examples | 32 |
| 5.2.1 | Basic Insulation resistance test..... | 32 |
| 5.2.2 | Voltage dependence test – Step Voltage Test | 32 |
| 5.2.3 | Time dependence test – Diagnostic Test | 32 |
| 5.2.4 | Withstanding Voltage Test..... | 34 |
| 5.3 | Guard terminal..... | 35 |
| 5.4 | Averaging options | 36 |
| 5.4.1 | The purpose of averaging..... | 36 |
| 5.4.2 | Example of averaging..... | 37 |
| 5.5 | Measurement menu..... | 38 |
| 5.6 | Insulation Resistance Measurement | 39 |
| 5.6.1 | Set Limit | 41 |
| 5.7 | Diagnostic test..... | 42 |
| 5.7.1 | Dielectric Absorption Ratio (DAR)..... | 44 |
| 5.7.2 | Polarization Index (PI) | 44 |
| 5.7.3 | Dielectric Discharge Testing (DD)..... | 45 |
| 5.8 | Step Voltage testing | 47 |
| 5.9 | Withstanding Voltage Test..... | 49 |
| 6 | Communication..... | 51 |
| 7 | Maintenance..... | 52 |
| 7.1 | Batteries insertion and replacement..... | 52 |
| 7.2 | Cleaning | 54 |
| 7.3 | Periodic calibration | 54 |
| 7.4 | Service | 54 |
| 8 | Technical specifications | 55 |
| 8.1 | General data..... | 58 |
| Appendix A – Remote Control | | 59 |

1 General Description

1.1 Features

TeraOhm XA 5kV (MI 3205) is a portable battery (Li-ion) or mains powered test instrument with excellent IP protection: **IP65** (case closed), **IP54** (case open), intended for diagnosing of Insulation Resistance by using high test voltages of up to 5 kV. It is designed and produced with the extensive knowledge and experience acquired through many years of working in this field.

Available functions and features offered by the **TeraOhm XA 5kV** meter:

- Wide measuring range (10 kΩ ... 15 TΩ);
- Insulation Measurement;
- Step Voltage Test;
- Withstanding Voltage Test (DC) up to 5 kV;
- Polarization Index (PI);
- Dielectric Absorption ratio (DAR);
- Dielectric Discharge ratio (DD);
- Graph R(t);
- Adjustable test voltage (50 V...5 kV) 50 V and 100 V step;
- Programmable timer;
- Automatic discharge of test object after completion of measurement;
- Capacitance measurement;
- Input AC current noise rejection 1 mA@300 V (4 mA max);
- High voltage breakdown detection;
- Limit status;
- Additional averaging (filters) of the result (5, 10, 30, 60)
- Bluetooth, USB and RS232 communication;
- High power Li-ion battery pack (14.8V, 4.4Ah);
- High overvoltage category CAT IV / 600 V.



A **320x240 dot matrix LCD** offers easy-to-read results and all associated parameters. The operation is straightforward and clear to enable the user to operate the instrument without the need for special training (except reading and understanding this Instruction Manual).

Test results can be stored on the instrument. PC software HVLink PRO that is supplied as a part of standard set enables transfer of measured results to PC where can be analyzed or printed.

2 Safety and operational considerations

2.1 Warnings and notes

In order to maintain the highest level of operator safety while carrying out various tests and measurements Metrel recommends keeping your **TeraOhm XA 5 kV** test equipment in good condition and undamaged. When using this test equipment, consider the following general warnings:

- ◆ The  symbol on the test equipment means »Read the Instruction manual with special care for safe operation«. The symbol requires an action!
- ◆ The  symbol on the test equipment means “Hazardous voltage may be present at the test terminals!”.
- ◆ If the test equipment is used in a manner not specified in this Instruction manual, the protection provided by the equipment could be impaired!
- ◆ Read this Instruction manual carefully, otherwise the use of the test equipment may be dangerous for the operator, the test equipment itself or for the tested object!
- ◆ Do not use the test equipment or any of the accessories if any damage is noticed!
- ◆ Consider all generally known precautions in order to avoid risk of electric shock while dealing with hazardous voltages!
- ◆ Do not connect the test equipment to a mains voltage different from the one defined on the label adjacent to the mains connector, otherwise it may be damaged.
- ◆ Service intervention or adjustment is only allowed to be carried out by competent authorized personnel!
- ◆ Hazardous voltages exist inside the test equipment. Disconnect all test leads, remove the power supply cable and switch off the test equipment before opening the battery compartment.
- ◆ All normal safety precautions must be taken in order to avoid risk of electric shock while working on electrical installations!
- ◆ Do not use the equipment in a wet environment, around explosive gas, vapour or dust.
- ◆ Only adequately trained and competent persons may operate the equipment.



Warnings related to measurement functions: Working with the instrument

- ◆ Use only standard or optional test accessories supplied by your distributor!
- ◆ Always connect accessories to the test equipment and to the test object before starting high voltage measurement. Do not touch test leads or crocodile clips during measurement.
Only hand-held part of high voltage test lead with tip is allowed to be touched (held) during measurement.

- ◆ Do not touch any conductive parts of equipment under test during the test, risk of electric shock!
- ◆ Make sure that the tested object is disconnected (mains voltage disconnected) and de-energized before connecting the test leads and starting the measurement (except Voltage measurement)!
- ◆ In case of a capacitive test object, automatic discharge of the object may not be done immediately after finishing the measurement.
- ◆ Do not connect test terminals to an external voltage higher than 600 V DC or AC (CAT IV environment) to prevent any damage to the test equipment!
- ◆ In rare cases (internal fault) the test equipment can behave in an uncontrolled manner (LCD blinking, freezing, not responding to keys, etc.). In this case consider the test equipment and the test object as hazardous live, and perform all safety measures to turn off (reset) the test equipment and to discharge the test object manually!

Handling with capacitive loads

- ◆ Note that 40 nF charged to 1 kV or 8 nF charged to 5 kV are hazardous live!
- ◆ Never touch the measured object during the testing until it is totally discharged automatically and manually!
- ◆ Because of dielectric absorption, capacitive test objects (capacitors, cables, transformers, etc.) must be shorted out after the measuring process is completed.

Note:

For **manual discharge** Metrel recommends the use of A 1513 Discharge link. The internal discharge resistors of A 1513 ensure a damped discharge up to 10 uF at 10 kV.

Warnings related to Batteries:

- ❑ **Use only batteries provided by the manufacturer.**
- ❑ **Never dispose of the batteries in a fire as it may cause them to explode or generate a toxic gas.**
- ❑ **Do not attempt to disassemble, crush or puncture the batteries.**
- ❑ **Do not short circuit or reverse polarity the external contacts on a battery.**
- ❑ **Keep the battery away from children.**
- ❑ **Avoid exposing the battery to excessive shock/impacts or vibration.**
- ❑ **Do not use a damaged battery.**
- ❑ **The Li – ion battery contains safety and protection circuit which, if damaged, may cause the battery to generate heat, rupture or ignite.**
- ❑ **Do not leave a battery on prolonged charge when not in use.**
- ❑ **If a battery has leaking fluids, do not touch any fluids.**
- ❑ **In case of eye contact with fluid, do not rub eyes. Immediately flush eyes thoroughly with water for at least 15 minutes, lifting upper and lower lids, until no evidence of the fluid remains. Seek medical attention.**

2.2 Battery and charging of Li-ion battery pack

The instrument is designed to be powered by rechargeable Li-ion battery pack or with mains supply. The LCD contains an indication of battery condition and the power source (upper left section of LCD). In case the battery is too weak the instrument indicates this as shown in Figure 2.1.

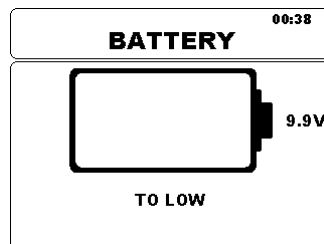
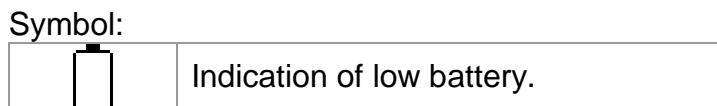

Figure 2.1: Battery test

The battery is charged whenever the power supply is connected to the instrument. The power supply socket is shown in Figure 2.2. Internal circuit controls (CC, CV) charging and assures maximum battery lifetime. Nominal operating time is declared for battery with nominal capacity of 4.4 Ah.



Figure 2.2: Power supply socket (C7)

The instrument automatically recognizes the connected power supply and begins charging.

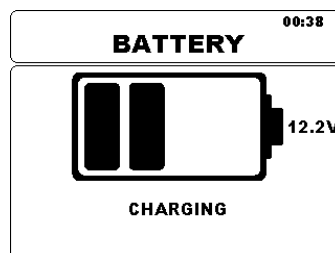
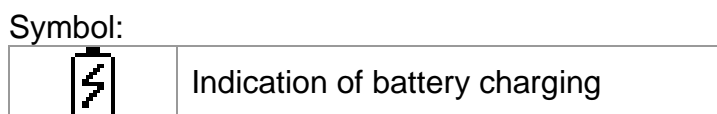

Figure 2.3: Charging indication

| Battery and charging characteristic | Typical |
|-------------------------------------|----------|
| Battery type | VB 18650 |
| Charging mode | CC / CV |
| Nominal voltage | 14,8 V |
| Rated capacity | 4,4 Ah |
| Max charging voltage | 16,7 V |
| Max charging current | 1,2 A |
| Max discharge current | 2,5 A |
| Typical charging time | 4 hours |

Typical charging profile which is also used in this instrument is shown in Figure 2.4.

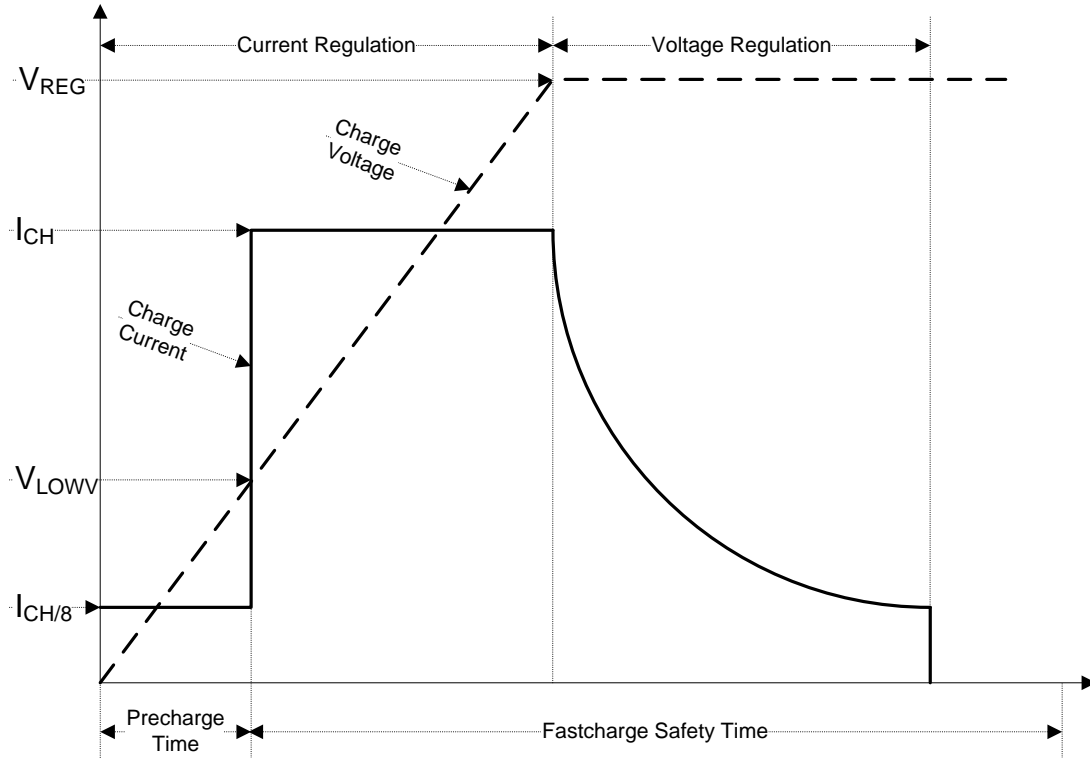

Figure 2.4: Typical charging profile

where:

- V_{REG} Battery charging voltage
- V_{LOWV} Precharge threshold voltage
- I_{CH} Battery charging current
- $I_{CH/8}$ 1/8 of the charging current

2.2.1 Precharge

On power up, if the battery voltage is below the V_{LOWV} threshold, the charger applies 1/8 of the charging current to the battery. The precharge feature is intended to revive deeply discharged battery. If the V_{LOWV} threshold is not reached within 30 minutes of initiating precharge, the charger turns off and a FAULT is indicated.

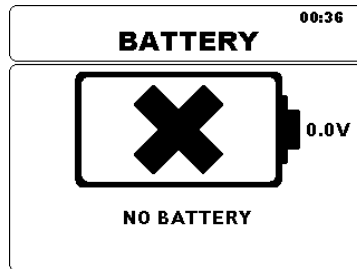

Figure 2.5: No battery indication

Note:

- As a safety backup, the charger also provides an internal 5-hour charge timer for fast charge.

Typical charging time is 4 hours in the temperature range of 5°C to 60°C.

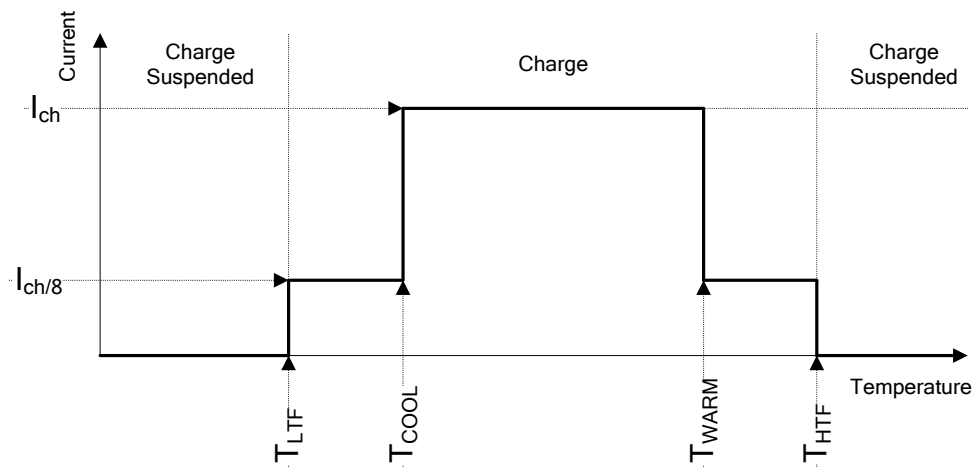

Figure 2.6: Typical charging current vs temperature profile

where:

- T_{LTF} Cold temperature threshold (typ. -15°C)
- T_{COOL} Cool temperature threshold (typ. 0°C)
- T_{WARM} Warm temperature threshold (typ. +60°C)
- T_{HTF} Hot temperature threshold (typ. +75°C)

The charger continuously monitors battery temperature. To initiate a charge cycle, the battery temperature must be within the T_{LTF} to T_{HTF} thresholds. If battery temperature is outside of this range, the controller suspends charge and waits until the battery temperature is within the T_{LTF} to T_{HTF} range.

If the battery temperature is between the T_{LTF} and T_{COOL} thresholds or between the T_{WARM} and T_{HTW} thresholds, charge is automatically reduced to $I_{CH/8}$ (1/8 of the charging current).

2.2.2 Li – ion battery pack guidelines

Li – ion rechargeable battery pack require routine maintenance and care in their use and handling. Read and follow the guidelines in this user manual to safely use Li – ion battery pack and achieve the maximum battery life cycles.

Do not leave batteries unused for extended periods of time (self – discharge). When a battery has been unused for 6 months, check the charge status see chapter 3.4.4 Battery, time and communication indication. Rechargeable Li – ion battery pack have a limited life and will gradually lose their capacity to hold a charge. As the battery loses capacity, the length of time it will power the product decreases.

Storage:

- ❑ Charge or discharge the instruments battery pack to approximately 50% of capacity before storage.
- ❑ Charge the instrument battery pack to approximately 50% of capacity at least once every 6 months.

Transportation:

- ❑ Always check all applicable local, national, and international regulations before transporting a Li – ion battery pack.



Handling Warnings:

- ❑ **Use only batteries provided by the manufacturer.**
- ❑ **Do not disassemble, crush, or puncture a battery in any way.**
- ❑ **Do not short circuit or reverse polarity the external contacts on a battery.**
- ❑ **Do not dispose of a battery in fire or water.**
- ❑ **Keep the battery away from children.**
- ❑ **Avoid exposing the battery to excessive shock/impacts or vibration.**
- ❑ **Do not use a damaged battery.**
- ❑ **The Li – ion battery contains safety and protection circuit which, if damaged, may cause the battery to generate heat, rupture or ignite.**
- ❑ **Do not leave a battery on prolonged charge when not in use.**
- ❑ **If a battery has leaking fluids, do not touch any fluids.**
- ❑ **In case of eye contact with fluid, do not rub eyes. Immediately flush eyes thoroughly with water for at least 15 minutes, lifting upper and lower lids, until no evidence of the fluid remains. Seek medical attention.**

2.3 Standards applied

The TeraOhm XA 5kV instrument is manufactured and tested in accordance with the following regulations:

Electromagnetic compatibility (EMC)

EN 61326 Electrical equipment for measurement, control and laboratory use – EMC requirements Class A

Safety (LVD)

EN 61010 - 1 Safety requirements for electrical equipment for measurement, control and laboratory use – Part 1: General requirements

EN 61010 - 2 - 030 Safety requirements for electrical equipment for measurement, control and laboratory use – Part 2-030: Particular requirements for testing and measuring circuits

EN 61010 - 031 Safety requirements for hand-held probe assemblies for electrical measurement and test.

Some further recommendations

IEEE 43 – 2000 Recommended Practice for Testing Insulation Resistance of Rotating Machinery:

- ❑ 1 M Ω + 1 M Ω / 1000 V rating of equipment for insulation systems prior to 1970;
- ❑ 5 M Ω for random wound motors under 600 Volts;
- ❑ 100 M Ω for form wound motors over 600 Volts, and armatures;

IEC 60439-1 Low-voltage switchgear and control gear assemblies - Part 1: Type-tested and partially type-tested assemblies:

- ❑ Scope of the insulation resistance test: alternative method for verification of dielectric properties by insulation resistance measurement;
- ❑ Description: a d.c. test voltage (500 V) is applied to the insulation and its resistance is measured. Insulation is proper, if its resistance is high enough (1000 Ω / V of circuit rated voltage);

IEC 61558 Isolating transformers and safety isolating transformers:

- ❑ Test voltage: 500 V, measurement period: 1 min;
 - ❑ Minimum insulation resistance for basic insulation: 2 M Ω ;
 - ❑ Minimum insulation resistance for supplementary insulation: 5 M Ω ;
 - ❑ Minimum insulation resistance for reinforced insulation: 7 M Ω ;
-

Li – ion battery pack

IEC 62133 Secondary cells and batteries containing alkaline or other non-acid electrolytes - Safety requirements for portable sealed secondary cells, and for batteries made from them, for use in portable applications.

Note:

Immunity to radiated RF fields (Field strength: 10V/m, Modulation: AM, 80%, 1 kHz)

| Voltage Range | Operational conditions | Disturbance < 5 % | Disturbance > 5 % |
|---------------|------------------------|-------------------|-------------------|
| 50 V | 100 M Ω | 300 MHz ÷ 900 MHz | 900 MHz ÷ 1 GHz |

Note about EN and IEC standards:

- ❑ Text of this manual contains references to European standards. All standards of EN 6XXXX (e.g. EN 61010) series are equivalent to IEC standards with the same number (e.g. IEC 61010) and differ only in amended parts required by European harmonization procedure.

3 Instrument description

3.1 Instrument casing

The instrument is housed in a plastic box that maintains the protection class defined in the general specifications.

3.2 Operator’s panel

The operator’s panel is shown in Figure 3.1 below.

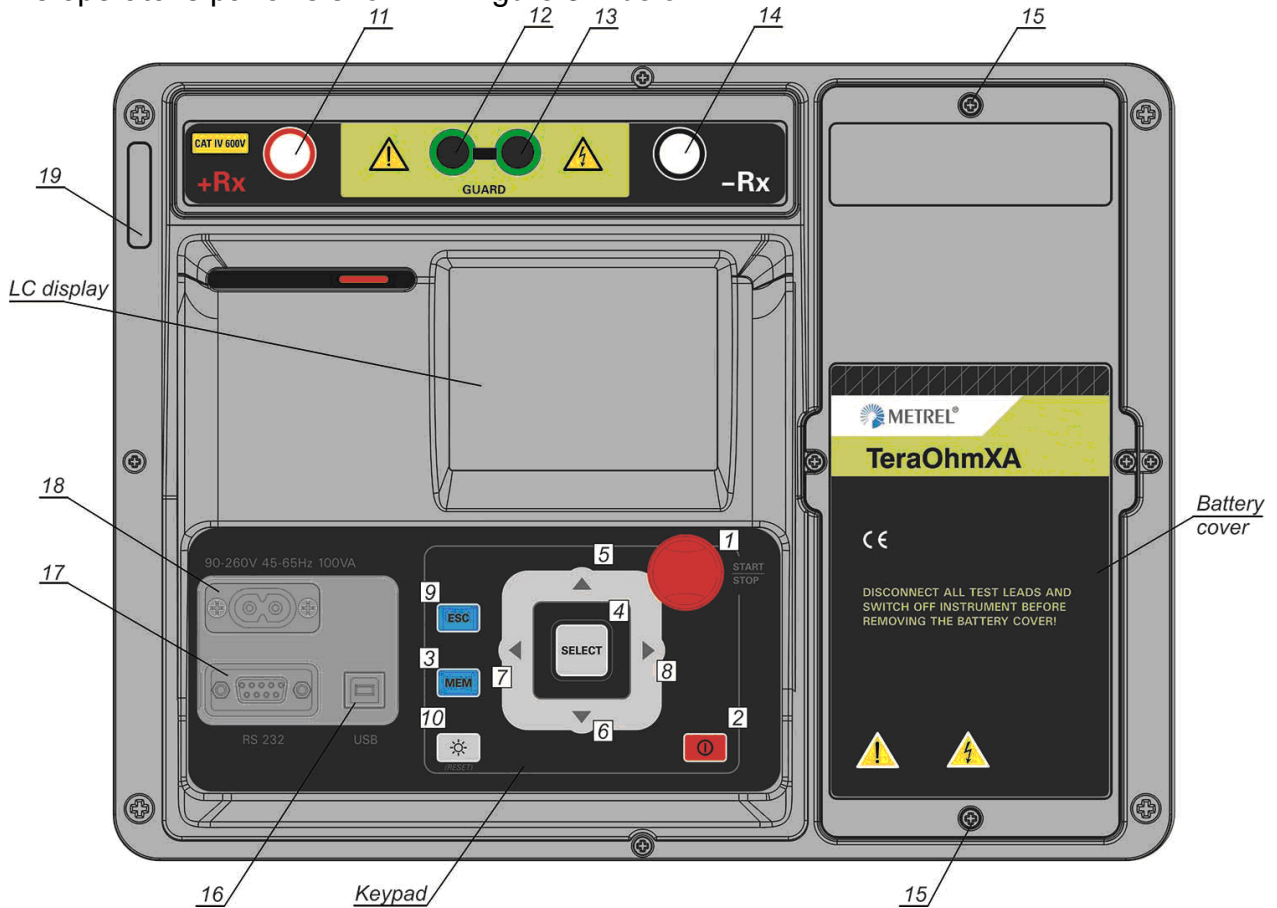



Figure 3.1: The operator’s panel

Keypad Section:

| | | |
|-----|---------------------|--|
| 1 | START / STOP | Start or stop measurement. |
| 2 | ON / OFF | Switches the instrument power on or off. The instrument automatically turns off 15 minutes after the last key was pressed (Hard OFF – hold key for 8 s). |
| 3 | MEM | Store / recall / clear tests in memory of the instrument. |
| 4 | SELECT | To enter set-up mode for the selected function or to select the active parameter to be set. |
| 5,6 | ▲ ▼ | Select an option upward, downward. |
| 7,8 | ◀ ▶ | Decrease, increase the selected parameter. |
| 9 | ESC | Exit the selected mode. |

| | | |
|---|---|---|
| 10 |  | Turn the display backlight ON or OFF. Instrument's RESET (hold key for 5 s or more). |
| <i>Display Section:</i> | | |
| 20 | | High voltage warning light (red). |
| <i>Terminal Section:</i> | | |
| 11 | + Rx | Positive high voltage output terminal. |
| 12,13 | GUARD | Guard input terminals. |
| 14 | - Rx | Negative high voltage output terminal. |
| <i>Power and Communication Section:</i> | | |
| 19 | C7 | Input power supply socket (C7) |
| 18 | USB | USB communication port (standard USB connector - type B) |
| 18 | RS232 | RS232 communication port (standard RS232 9-pin D female) |

Warnings!

- ❑ **Maximum allowed voltage between any test terminal and ground is 600 V!**
- ❑ **Maximum allowed input voltage between test terminals is 50 V! Use original test accessories only!**

3.3 Accessories

The accessories consist of standard and optional accessories. Optional accessories can be delivered upon request. See *attached* list for standard configuration and options or contact your distributor or see the METREL home page: <http://www.metrel.si>.

3.3.1 Test leads

The standard length of high voltage shielded test lead with tip is 2 m. The standard length of high voltage shielded test leads with (red, black) banana connectors is 3 m; optional lengths are 8 m and 15 m. For more details see attached list for standard configuration and options or contact your distributor or see the METREL home page: <http://www.metrel.si>.

All test leads are made of high voltage shielded cable, because shielded cable provides higher accuracy and immunity to disturbance of measurements that can occur in industrial environments.

High voltage shielded test leads with High voltage alligator clips.

Application notes:

This test leads are designed for diagnostic testing of insulation. They can also be used for hand held testing with test voltages up to 5 kV d.c..

Insulation ratings:

- ❑ High voltage banana connectors (red, black): 5 kV d.c. (reinforced insulation);
- ❑ Alligator clips (red, black): 5 kV d.c. (reinforced insulation);
- ❑ Guard banana connector (green): 600 V CAT IV (reinforced insulation);
- ❑ Cable (yellow): 12 kV (shielded).



Figure 3.2: HV test leads with alligator clips

Guard test lead with alligator clips

Insulation ratings:

- ❑ Guard test lead with banana connectors (green): 600 V CAT IV (reinforced insulation);
- ❑ Alligator clip (green): 600 V CAT IV (reinforced insulation)



Figure 3.3: Guard lead with alligator clip

3.4 Display organization

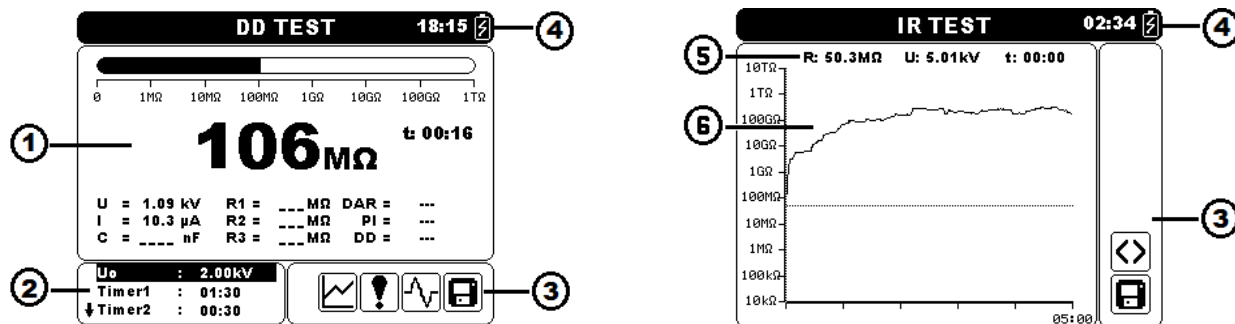

Figure 3.4: Typical function display and graph screen

| | |
|---|--|
| 1 | Measurement result window |
| 2 | Measurement control window |
| 3 | Messages window |
| 4 | Battery, time and communication indication |
| 5 | Measurement result line |
| 6 | Graphical presentation of measured data |

3.4.1 Measurement result window

Measurement window shows all relevant data during measurement campaign.

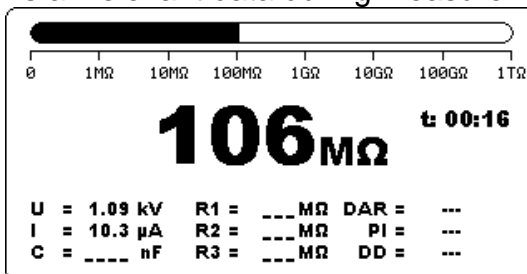

Figure 3.5: Measurement window

Measured Insulation resistance Is shown in the center of a screen with the largest font. During measurement campaign this result is refreshed every few seconds. When the measurement is completed result is hold on screen, until new measurement is started.

Bar graph Graphically represents measured insulation resistance in respect to the measurement range. It also displays limit value if it is enabled.

U Shows the output voltage. During measurement campaign this result is refreshed every few seconds. When the measurement is completed result is hold on screen, until new measurement is started.

I Shows the input current. During measurement campaign this result is refreshed every few seconds. When the measurement is completed result is hold on screen, until new measurement is started.

| | |
|---------------------------|---|
| C | Shows the capacitance measured at the output terminals. Value of capacitance is measured during the final discharge of the test object. |
| R1, R2, R3 | Show resistances measured at Timer1, Timer2 and Timer3. When the measurement is completed result is hold on screen, until new measurement is started (appears only in Diagnostic Test). |
| R1, R2, R3,R4, R5 | Show resistances measured at steps one to five. When the measurement is completed result is hold on screen, until new measurement is started (appears only in Step Voltage Test). |
| U1, U2, U3, U4, U5 | Show voltages measured at steps one to five. When the measurement is completed result is hold on screen, until new measurement is started (appears only in Step Voltage Test). |
| DAR | Show the Dielectric Absorption Ratio. When the measurement is completed result is hold on screen, until new measurement is started (appears only in Diagnostic Test). |
| PI | Show the Polarization Index. When the measurement is completed result is hold on screen, until new measurement is started (appears only in Diagnostic Test). |
| DD | Show the Dielectric Discharge result. When the measurement is completed result is hold on screen, until new measurement is started (appears only in Diagnostic Test). |
| f | Shows frequency of the measured voltage (appears only in True RMS Voltmeter). |
| t | Shows test time (mm:ss). |

3.4.2 Measurement control window

Control window permit user to modify control measurement parameters.

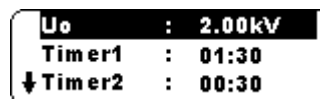

Figure 3.6: Control window

| | |
|---------------|---|
| Un | Allows user to set the desired test voltage. |
| Timer1 | Allows user to set the desired measurement duration in Insulation Resistance test. Delay for starting DAR measurement in Diagnostic test. (mm:ss) – step 1 s (max time 99 min). |











| | |
|---------------|---|
| Timer2 | Delay for starting PI measurement (mm:ss) – step 1 s (max time 99 min). |
| Timer3 | Allows user to set the desired measurement duration (mm:ss) – step 1 s (max time 99 min). |
| DD | Allows user to enable or disable Dielectric Discharge measurement. |
| ltrgg | Allows user to set the desired trigger level – step 100 μ A (max current 5 mA). |
| Tstart | Allows user to set the start test voltage time (mm:ss) – step 1s (max time 99 min). |
| Tend | Allows user to set the constant end test voltage time (mm:ss) – step 1 s (max time 99 min). |
| Ustart | Allows user to set the desired start test voltage. |
| Uend | Allows user to set the desired end test voltage. |
| Tramp | Allows user to set the duration of the test ramp (mm:ss) – step 1 s (max time 99 min). |
| HI Lim | Allows user to set the high limit (value is evaluated at the end of the measurement). |
| AVG | Allows user to set the additional averaging of the result (OFF, 5, 10, 30, 60). |

3.4.3 Message window

In the message field warnings and messages are displayed.







Figure 3.7: Message window

| | |
|---|--|
|  | High voltage is present on measuring terminals (> 50 V rms). |
|  | Test result can be saved. |
|  | AC noise is present on the measuring terminals (+ Rx, - Rx). |
|  | A Breakdown or Over voltage event has accrued. |
|  | Instrument is overheated. Measurement process is disabled. |
|  | Graph is enabled. |
|  | Graph logging is enabled (internal Flash memory). |
|  | Internal Flash memory is full (graph logging is disabled). |
|  | Measurement result is within defined limits. |
|  | Measurement result is out of defined limits. |

3.4.4 Battery, time and communication indication

These symbols indicate the charge condition of a battery, charger connection and communication status. Time indication is also present.

| | |
|---|--|
|  | Battery capacity indication. |
|  | Low battery. <i>Recharge the battery.</i> |
|  | Recharging in progress (if mains supply cable is connected). |
| 08:26 | Time indication (hh:mm). |
|  | USB communication is enabled. |
|  | Bluetooth communication is enabled. |

Note:

- Date and time is attached to each stored result.

3.4.5 Measurement result line

| | |
|----------|--|
| R | Shows Insulation resistance. During measurement campaign this result is refreshed every few seconds. When the measurement is completed it represents Insulation resistance at cursor position. |
| U | Shows the output voltage. During measurement campaign this result is refreshed every few seconds. When the measurement is completed it represents output voltage at cursor position. |
| t | Shows test time (mm:ss). When the measurement is completed it represents time at cursor position. |

Note:

- Averaging in measurement result line is disabled during measurement campaign in all functions regardless of settings.

3.4.6 Graphical presentation of measured data

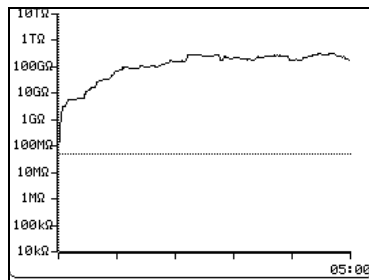

Figure 3.8: Graph screen

Measured or averaged Insulation resistance values in relation to time of measurement are represented in this two dimensional R/t diagram. Online plotting, during measurement, can also be observed. When the measurement is completed cursor is attached to the graph for detail analysis.

3.4.7 Backlight operation

After turning the instrument ON the LCD backlight is automatically turned ON. It can be turned OFF and ON by simply clicking the ☀ (**LIGHT**) key.

Note:

- If you press and hold the Light (☀) key for approximately 5 s the instrument will RESET!

4 Main menu

4.1 Instrument Main menu

From the Main menu of the instrument there are five options available: Measurements, Custom tests, Memory menu, Settings menu and Help menu.

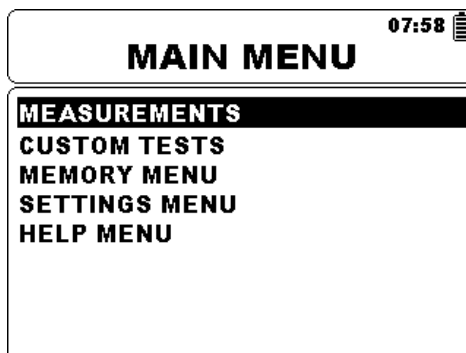

Figure 4.1: Instrument Main menu

Keys:

Select one of the following menu items:

<**Measurements**> See chapter 4.5;

<**Custom tests**> See chapter 4.2;

<**Memory menu**> Memory management, see chapter 4.3;

<**Settings menu**> Setup of the instrument, see chapter 4.4;

<**Help menu**> Help screens, see chapter 4.6;

SELECT Confirms selection.

4.2 Custom tests

This menu contains a list of custom prepared tests. The commonly used tests are added to the list by default or user. Up to 30 custom tests can be pre-programmed.

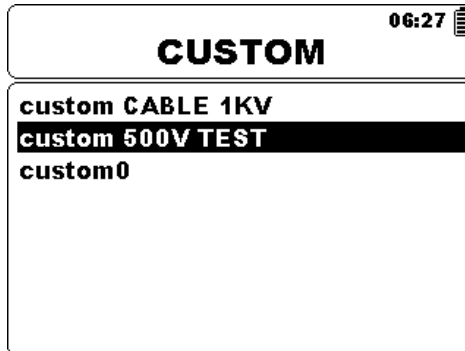

Figure 4.2: Custom Test Menu

Keys:

| | |
|---------------|---|
| ▲ ▼ | Select one of the following menu items: |
| SELECT | Confirms selection. |
| ESC | Returns to the <i>Main menu</i> . |

4.2.1 Creating custom test

The user has an option to save any custom made parameter settings. Simply enter the desired measurement, edit the test parameters and press **MEM** key. The insert text screen will appear if no result is left for save.

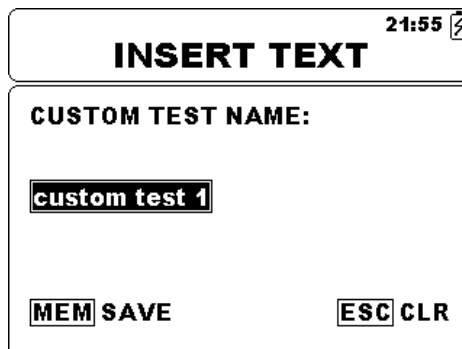

Figure 4.3: Insert text screen

Keys in Insert text screen:

| | |
|---------------|--|
| ▲ ▼ | Selects a letter. |
| SELECT | Selects the next letter. |
| MEM | Confirm name and return to the selected measurement. |
| ESC | Deletes last letter. Returns to selected measurement without changes. |

4.3 Memory menu

Measurement result with all relevant parameters can be stored into the instrument's memory. The instrument's memory space is divided into 3 levels: OBJECT, DUT and LINE. The OBJECT, DUT and LINE level can contain up to 199 locations.

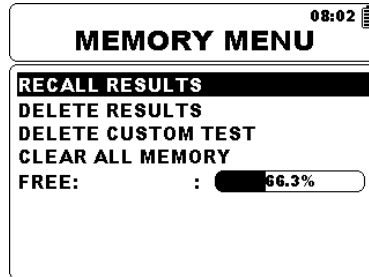

Figure 4.4: Memory Menu

Keys:

| | |
|---------------|------------------------------------|
| ▲ ▼ | Select one of the following items. |
| SELECT | Confirms selection. |
| ESC | Returns to the <i>Main menu</i> . |

4.3.1 Saving results

After the completion of a test, the results and parameters are ready for storing. By pressing the **MEM** key the user can enter storing menu.

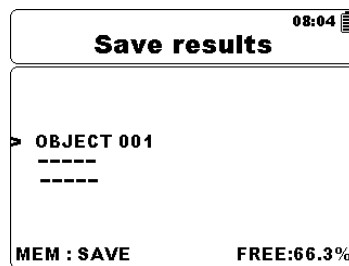

Figure 4.5: Storing Menu

Keys:

| | |
|------------|---|
| ◀ ▶ | Selects OBJECT, DUT and LINE number. |
| ▲ ▼ | Jump to a different location. |
| MEM | Saves measurement result to selected location and returns to the <i>Measurement result screen</i> . |
| ESC | Returns to the <i>Measurement result screen</i> without save. |

The instrument will beep in order to indicate that result is successfully saved into the memory.

Note:

- Every stored test result also includes date and time stamp (dd:mm:yyyy, hh:mm).

4.3.2 Recalling results

To enter Recall results menu in Memory menu **SELECT** key should be pressed.

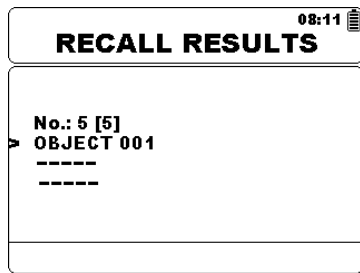

Figure 4.6: Recall Results menu

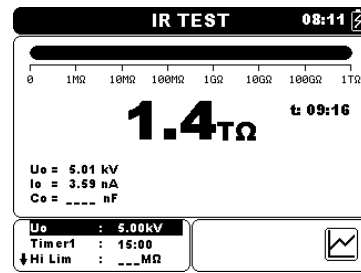

Figure 4.7: Recalled result screen

Keys in Recall menu:

| | |
|---------------|---|
| ▲ ▼ | Selects one of the following items OBJECT / DUT / LINE. |
| ◀ ▶ | Decreases or increase the parameter. |
| SELECT | Recalls result in selected location. |
| ESC | Returns to the Memory menu . |

Keys in Recall result screen:

| | |
|---------------|---|
| ◀ ▶ | Toggles between the saved results under selected OBJECT / DUT / LINE. |
| SELECT | Enters Recall result graph screen if available. |
| ESC | Returns to the Recall results menu . |

Keys in Recall result graph screen:

| | |
|---------------|---|
| ◀ ▶ | Scroll the cursor along logged data. |
| SELECT | Returns to Recall result screen . |
| ESC | Returns to the Recall results menu . |

4.3.3 Deleting results

To enter Delete results menu in Memory menu **SELECT** key should be pressed. Single measurement or all measurements under selected OBJECT, DUT and LINE can be deleted.

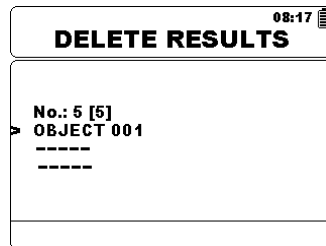

Figure 4.8: Delete all measurements under selected Object

Keys in Delete results menu:

| | |
|---------------|---|
| ▲ ▼ | Selects one of the following items OBJECT / DUT / LINE. |
| ◀ ▶ | Decreases or increases the parameter. |
| SELECT | Enters Delete confirmation screen. |
| MEM | Enters measurements field for deleting individual measurements. |
| ESC | Returns to the Memory menu . |

Keys in measurements field for deleting individual measurements:

| | |
|------------------|------------------------------------|
| ◀ ▶ | Select measurement to be deleted. |
| SELECT | Enters Delete confirmation screen. |
| ESC / MEM | Returns to the structure field. |

Keys in Delete confirmation screen:

| | |
|---------------|--|
| SELECT | Deletes result(s) in selected location. |
| ESC | Returns to the Delete results menu without changes. |

4.3.4 Deleting custom test

A single custom test can be deleted by simply selecting the test from the list of all tests and pressing the MEM key.

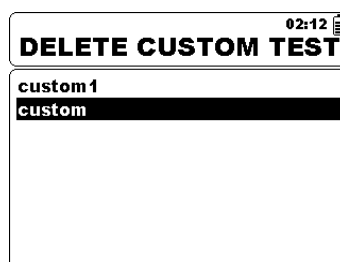

Figure 4.9: Deleting custom test

Keys in Deleting custom test menu:

| | |
|---------------|-------------------------------------|
| ▲ ▼ | Selects one of the following test. |
| SELECT | Delete selected test. |
| ESC | Returns to the Memory menu . |

4.3.5 Clearing complete memory content

When selecting the **Clear all memory** function in Memory menu all the memory content will be deleted.

Keys in Clear all memory confirmation screen:

| | |
|---------------|--|
| ◀ ▶ | Toggles between YES or NO. |
| SELECT | Clears all memory content (if YES is selected). |
| ESC | Returns to the Main menu without changes. |

4.4 Settings menu

In the Settings menu different parameters and settings of the instrument can be viewed or set.

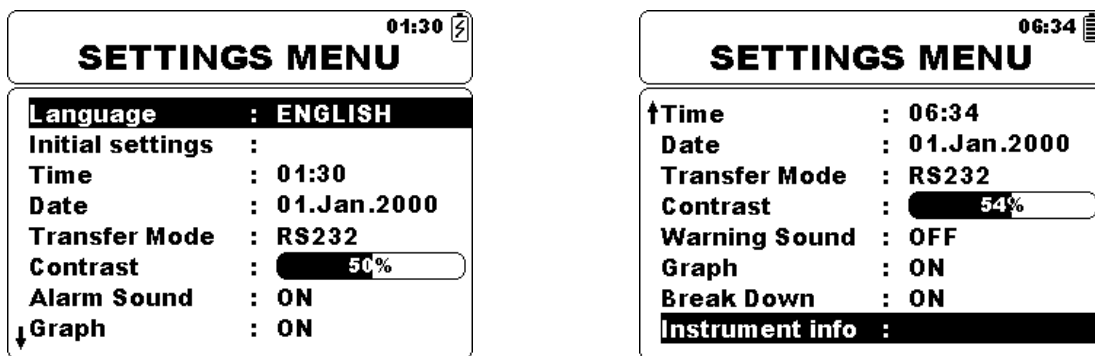

Figure 4.10: Settings menu

Keys:

Select the setting to adjust or view:

<Language> instrument language;

<Initial Settings> factory settings;

<Time> time settings;

<Date> date settings;

▲ ▼ <Transfer Mode> communication mode selection;

<Contrast> LCD contrast settings;

<Warning Sound> enables or disables high voltage warning sound;

<Graph> switches graph on or off;

<Break Down> enables or disables breakdown detection;

<Instrument Info> basic instrument information.

| | |
|---------------|-----------------------------------|
| SELECT | Confirms selection. |
| ESC | Returns to the Main menu . |

4.4.1 Language selection

The instrument language can be set.

Keys:

| | |
|-----|---|
| ◀ ▶ | Toggles between different languages (changes are stored automatically). |
|-----|---|

Note:

- No confirmation is needed to set the desired language.

4.4.2 Initial Settings selection

In this menu the following instrument parameters can be set to their initial values:

- All measurement parameters;
- Language;
- Transfer Mode;
- Contrast settings;
- Custom Measurements

Keys:

| | |
|---------------|---|
| ◀ ▶ | Toggles between YES or NO. |
| SELECT | Confirms selection and restart of the instrument (if YES is selected). |
| ESC | Returns to Main menu without changes. |

Note:

- Applying the initial settings will re-boot the instrument.

4.4.3 Time selection

In this selection the time of the instrument can be set.

Keys:

| | |
|---------------|---|
| ◀ ▶ | Decreases or increase the parameter (changes are stored automatically). |
| SELECT | Select the parameter to be changed. |

Time is attached to each stored result.

4.4.4 Date selection

In this selection the date of the instrument can be set.

Keys:

| | |
|---------------|---|
| ◀ ▶ | Decreases or increase the parameter (changes are stored automatically). |
| SELECT | Select the parameter to be changed. |

Date is attached to each stored result.

Note:

- If the battery is removed the instrument time and date will be lost.

4.4.5 Transfer mode

The instrument communication mode can be set.

Keys:

◀ ▶ Toggles between RS232, USB and Bluetooth.

Note:

- No confirmation is needed to set the desired transfer mode.

4.4.6 Contrast selection

In this selection the contrast of the display can be set.

Keys:

◀ ▶ Sets contrast value (changes are stored automatically).

Note:

- When using the instrument in a cold environment contrast level should be increased.

4.4.7 Warning sound

In this selection the Warning sound can be set. When enabled the Warning sound will beep when high voltage (≥ 50 V rms) is present on the input terminals +Rx to -Rx.

Keys:

◀ ▶ Toggles between YES or NO (changes are stored automatically).

4.4.8 Graph selection

In this selection the graph R(t) logging can be set.

Keys:

◀ ▶ Toggles between YES or NO (changes are stored automatically).

Note:

- When  icon is displayed the internal flash memory is full and graph logging is disabled.

4.4.9 Break Down selection

In this selection the Break down can be set. When triggered the Break down circuit automatically stops the measuring procedure.

Keys:

◀ ▶ Toggles between YES or NO (changes are stored automatically).

Notes:

- ❑ Break down is not active in Withstanding Voltage test and in the charging state of the high voltage generator.
- ❑ Break down is active if output voltages higher or equal then 1kV are set!

4.4.10 Instrument info

In this menu the following instrument data is shown:

- ❑ firmware version;
- ❑ serial number;
- ❑ calibration date;
- ❑ battery type.

4.5 Help Menu

The Help menu contains schematic diagrams for illustrating how to properly connect the instrument to the various test objects.

Keys in help menu:

▲ ▼ Selects next / previous help screen.

ESC Returns to the **Settings menu**.

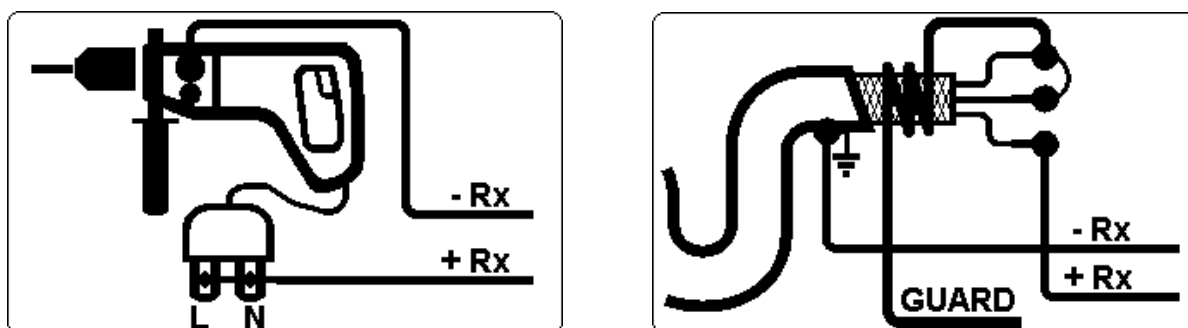

Figure 4.11: Examples of help screens

5 Measurements

5.1 General information about high voltage testing

5.1.1 The purpose of insulation tests

Insulating materials are important parts of almost every electrical product. The material's properties depend not only on its compound characteristics but also on temperature, pollution, moisture, ageing, electrical and mechanical stress, etc. Safety and operational reliability require the regular maintenance and testing of the insulation material to ensure it is kept in good operational condition. High voltage tests are used to test insulating materials.

5.1.2 DC vs. AC testing voltage

Testing with a DC voltage is widely accepted as being useful as testing with AC and / or pulsed voltages. DC voltages can be used for breakdown tests especially where high capacitive leakage currents interfere with measurements using AC or pulsed voltages. DC is mostly used for insulation resistance measurement tests. In this type of test, the voltage is defined by the appropriate product application group. This voltage is lower than the voltage used in the withstanding voltage test so the tests can be applied more frequently without stressing the test material.

5.1.3 Typical insulation tests

In general, insulation resistance tests consist of the following possible procedures:

- ❑ Simple insulation resistance measurement also called a spot test;
- ❑ Measurement of the relationship between voltage and insulation resistance;
- ❑ Measurement of the relationship between time and insulation resistance
- ❑ Test of residual charge after the dielectric discharge.

The results of this test can indicate whether the replacement of the insulation system is required.

Typical examples of where testing insulation resistance and its diagnosis are recommended are transformer and motor insulation systems, cables and other electrical equipment.

5.1.4 Electrical representation of insulating material

The Figure 5.1 represents the equivalent electrical circuit of an insulating material.

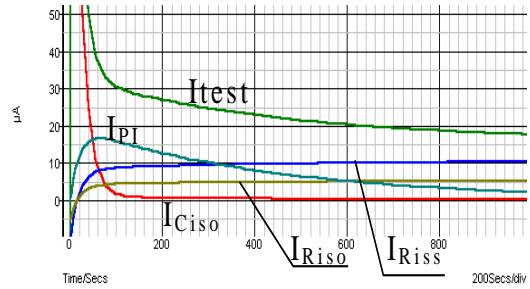
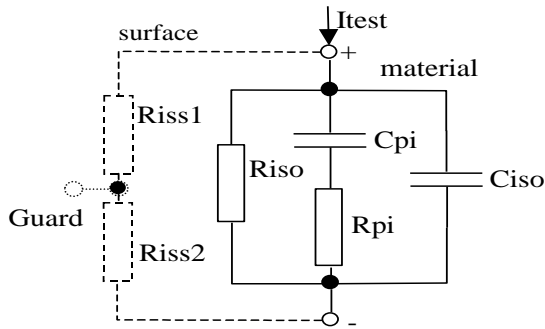

Figure 5.1: Insulating material

where:

- R_{iss1} and R_{iss2} Surface resistivity (position of optional guard connection)
- R_{iso} Actual insulation resistance of material
- C_{iso} Capacitance of material
- C_{pi} , R_{pi} Represents polarization effects
- I_{test} Overall test current ($I_{test} = I_{pi} + I_{Riso} + I_{Riss}$)
- I_{pi} Polarization absorption current
- I_{Riso} Actual insulation current
- I_{Riss} Surface leakage current

5.2 Some application examples

5.2.1 Basic Insulation resistance test

Virtually every standard concerning the safety of electrical equipment and installations requires the performance of a basic insulation testing. When testing lower values (in the range of $M\Omega$), the basic insulation resistance (Riso) usually dominates. The results are adequate and stabilize quickly.

It is important to remember the following:

- ❑ The voltage, time and limit are usually given in the appropriate standard or regulation.
- ❑ Measuring time should be set to 60 s or the minimum time required for the Insulation capacitance Ciso to be charged up.
- ❑ Sometimes it is required to take ambient temperature into account and adjust the result for a standard temperature of 40 °C.
- ❑ If surface leakage currents interfere with the measurements (see Riss above) use the guard connection. This becomes critical when measured values are in the $G\Omega$ range.

5.2.2 Voltage dependence test – Step Voltage Test

This test shows if the insulation under test has been electrically or mechanically stressed. In this instance the quantity and size of insulation anomalies (e.g. cracks, local breakdowns, conductive parts, etc). is increased and the overall breakdown voltage is reduced. Excessive humidity and pollution have an important role especially in the case of mechanical stress.

- ❑ The test voltage steps are usually close to those required in the DC withstanding test.
- ❑ Sometimes it is recommended that the maximum voltage for this test should not be higher than 60 % of the withstanding voltage.

If the results of successive tests show a reduction in the tested insulation resistance the insulation should be replaced.

5.2.3 Time dependence test – Diagnostic Test

5.2.3.1 Polarization Index – PI

The purpose of this diagnostic test is to evaluate the influence of the polarization part of insulation (R_{pi} , C_{pi}). After applying a high voltage to an insulator the electric dipoles distributed in the insulator align themselves with the applied electrical field. This phenomenon is called polarization. As the molecules polarize, a polarization (absorption) current lowers the overall insulation resistance of the material.

The absorption current (IPI) typically collapses after a few minutes. If the overall resistance of the material does not increase, this means that other currents (e.g. surface leakages) dominate the overall insulation resistance.

- ❑ PI is defined as the ratio of the measured resistances in two time slots. The most typical ratio is 10 min value to 1 min value but this is not a rule.

- ❑ The test is typically performed at the same voltage as the insulation resistance test.
- ❑ If the one-minute insulation resistance is greater than 5000 MΩ, then this measurement may not be valid (new modern types of insulation).
- ❑ Oiled paper used in transformers or motors is a typical insulation material that requires this test.

In general, insulators that are in good condition will show a “high” polarization index while insulators that are damaged will not. Note that this rule is not always valid. Refer to Metrel’s handbook **Insulation Testing Techniques** for more information.

General applicable values:

| PI value | Tested material status |
|---------------------------------------|---|
| 1 – 1.5 | Not acceptable (older types) |
| 2 – 4 (typically 3) | Considered as good insulation (older types) |
| > 4 (very high insulation resistance) | Modern type of (good) insulation systems |

Example for minimum acceptable values for motor insulation (IEEE 43):

Class A =1.5, Class B = 2.0, Class F =2.0, Class H =2.0.

5.2.3.2 Dielectric Discharge – DD

An additional effect of polarization is the recovered charge (from C_{pi}) after the regular discharging of a completed test. This can also be a supplementary measurement for evaluation of the quality of insulating material. This effect is generally found in insulating systems with large capacitance C_{iso}.

The polarization effect (described in “Polarization Index”) causes a capacitance to form (C_{pi}). Ideally this charge would dissipate immediately a voltage was removed from the material. In practice, this is not the case.

In conjunction with the polarization index (PI), Dielectric Discharge (DD) is another way to check the quality and suitability of a insulation material. A material that discharges quickly would provide a low value while a material that takes a long time to discharge will provide a higher value (described in the table below, for more information see section 5.6).

| DD value | Tested material status |
|----------|------------------------|
| > 4 | Bad |
| 2 – 4 | Critical |
| < 2 | Good |

5.2.4 Withstanding Voltage Test

Some standards allow the use of a DC voltage as an alternative to AC withstanding voltage testing. For this purpose the test voltage has to be present across the insulation under test for a specific time. The insulation material only passes if there is no breakdown or flash over. Standards recommend that the test starts with a low voltage and reaches the final test voltage with a slope that keeps the charging current under the limit of the current threshold. The test duration normally takes 1 min.

Withstanding voltage test or dielectric test is usually applied for:

- Type (acceptance) tests when a new product is being prepared for manufacture,
- Routine (production) tests for the verification of safety on each product,
- Maintenance and after service tests for any equipment where the insulation system can be exposed to degradation.

Some examples for DC withstanding test voltage values:

| Standard (only sample values) | Voltage |
|---|----------------|
| EN/IEC 61010-1 CAT II 300 V (mains circuits) basic insulation | 2100 V |
| EN/IEC 61010-1 CAT II 300 V (mains circuits) reinforced insulation | 4200 V |
| IEC 60439-1 (clearance between live parts...), withstanding impulse voltage 4 kV, 500 m | 4700 V |
| IEC 60598-1 | 2120 V |

Humidity and insulation resistance measurements

When testing outside the reference ambient conditions, the quality of the insulation resistance measurements can be affected by humidity. Humidity adds leakage paths onto the surface of the complete measuring system, (i.e. the insulator under test, the test leads, the measuring instrument etc). The influence of humidity reduces accuracy especially when testing very high resistances (i.e. Tera ohms). The worst conditions arise in environments containing high condensation, which can also reduce safety. In the case of high humidity, it is recommended to ventilate the test areas before and during the measurements. In the case of condensed humidity the measuring system must dry and it can take several hours or even few days to recover.

5.3 Guard terminal

The purpose of the GUARD terminal is to lead away potential leakage currents (e.g. surface currents), which are not a result of the measured insulation material itself but are a result of the surface contamination and moisture. This current interferes with the measurement i.e. the Insulation Resistance result is influenced by this current. The GUARD terminal is internally connected to the same potential as the negative test terminal (black one). The GUARDs test clip should be connected to the test object so as to collect most of the unwanted leakage current, see the Figure below.

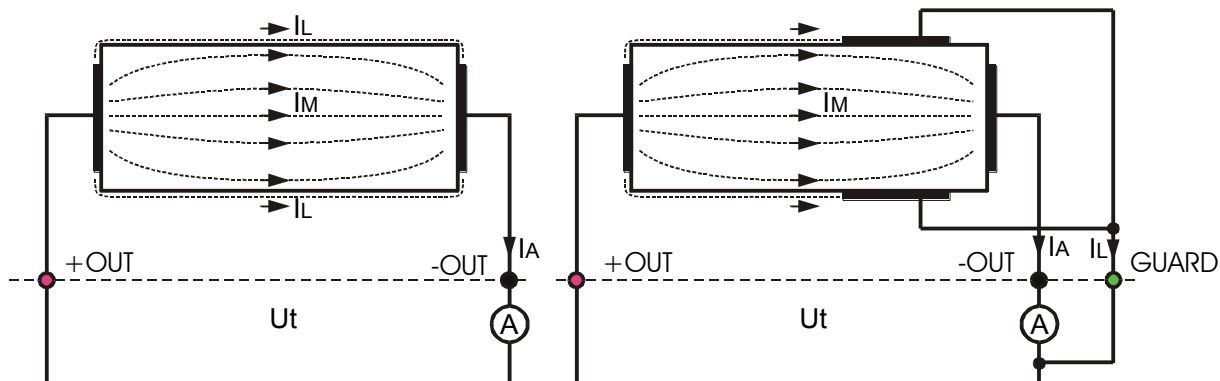

Figure 5.2: Connection of GUARD terminal to measured object

where:

- Ut..... Test voltage
- IL..... Leakage current (resulted by surface dirt and moisture)
- IM..... Material current (resulted by material conditions)
- IA A-meter current

Result without using GUARD terminal:

$$R_{ins} = \frac{U_t}{I_A} = \frac{U_t}{(I_M + I_L)} \text{ Incorrect result.}$$

Result using GUARD terminal:

$$R_{ins} = \frac{U_t}{I_A} = \frac{U_t}{I_M} \text{ Correct result.}$$

It is recommended to use the GUARD connection when high insulation resistance (>10 GΩ) are measured.

Notes:

- ❑ The guard terminal is protected by internal impedance (400 kΩ).
- ❑ The instrument has two guard terminals to allow easy connection of shielded measuring leads.

5.4 Averaging options

Filters and additional averaging are built in to reduce the influence of noise on measurement results. This option enables more stable results especially when dealing with high Insulation Resistances.

In Insulation Measurement the status of the averaging option is shown in measurement control window of the LCD screen. The table below contains a definition of the individual filter options:

| Averaging options | Settling time | Meaning |
|-------------------|---------------|------------------------------|
| - - - | 0 s | Averaging is disabled |
| 5 results | 5 s | Moving average of 5 results |
| 10 results | 10 s | Moving average of 10 results |
| 30 results | 30 s | Moving average of 30 results |
| 60 results | 60 s | Moving average of 60 results |

5.4.1 The purpose of averaging

In simple terms the averaging smooth's the measured.

There are various sources of disturbance:

- ❑ AC currents at the mains frequency and its harmonics, switching transients etc, cause the results to become unstable. These currents are mostly cross talk through insulation capacitances close to live systems,
- ❑ Other currents induced or coupled in the electromagnetic environment of the insulation under test.
- ❑ **Ripple current from internal high voltage source.**

$$i(t) = C \times \frac{dU(t)}{dt}$$

- ❑ Charging effects of high capacitive loads and / or long cables.

Voltage changes are relatively narrow on high resistance insulation, so the most important point is to filter the measured current.

Notes:

- ❑ Any of the selected averaging options increases the settling time.
- ❑ It is necessary to pay close attention to the selection of time intervals when using the averaging.
- ❑ The recommended minimum measuring times when using averaging are the settling times of the selected averaging option.

5.4.2 Example of averaging

Capacitive test object 200 nF
 Insulation Resistance Measurement

Test parameters:

Un = 5.00 kV

Timer1 = 5:00 min

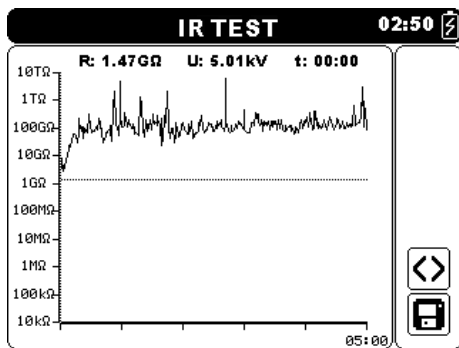

Figure 5.3: Insulation Meas. (AVG _ _ _)

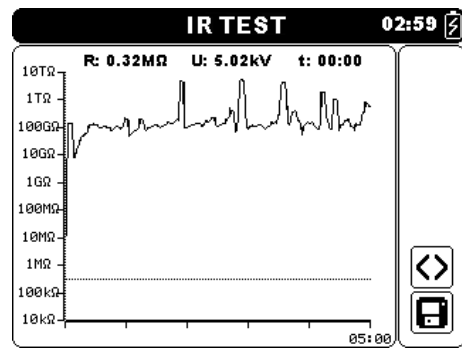

Figure 5.4: Insulation Meas. (AVG 5s)

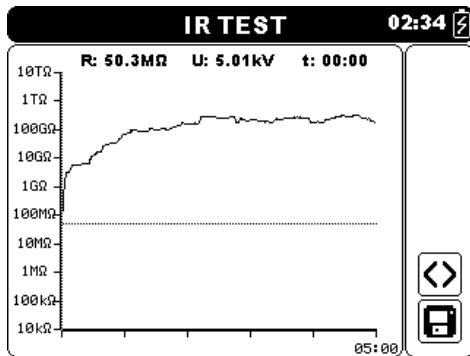

Figure 5.5: Insulation Meas. (AVG 30s)

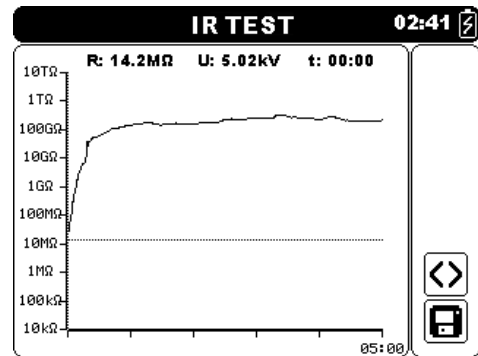

Figure 5.6: Insulation Meas. (AVG 60s)

5.5 Measurement menu

In the Measurement menu 4 different measurements and tests can be selected.

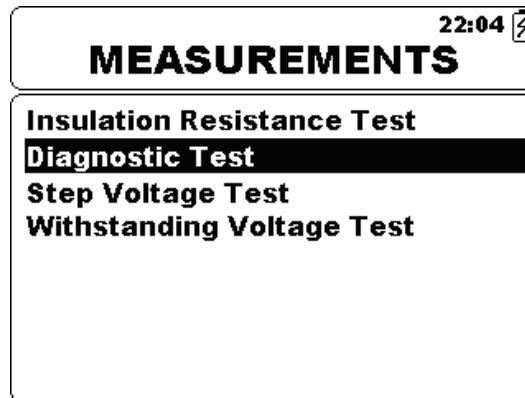

Figure 5.7: Measurement menu

Keys:

| | |
|---------------|--|
| ▲ ▼ | Selects measurement or test. |
| SELECT | Enters selected measurement function window. |
| ESC | Returns to the Main menu . |

5.6 Insulation Resistance Measurement

Test can be started from the Insulation Resistance Measurement window. Before carrying out a test the parameters output voltage, timer, high limit and additional averaging can be edited.

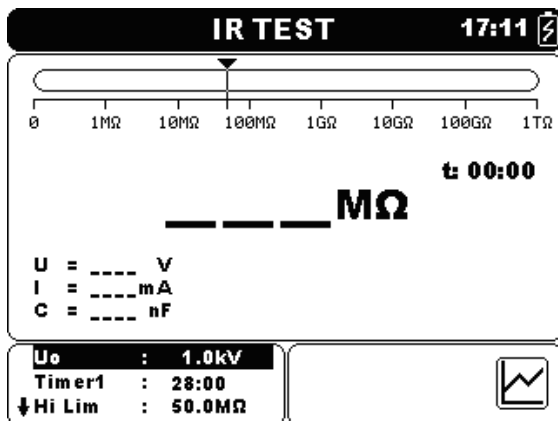

Figure 5.8: Insulation Resistance Measurement menu

Test parameters for Insulation resistance Measurement

| | |
|---------------|---|
| Un | Set test voltage – step 50 V (50 V – 1 kV) and 100 V (1 kV – 5 kV). |
| Timer1 | Duration of measurement (mm:ss) – step 1 s (max time 99 min). |
| Hi Lim | Limit value selection (OFF, 0.50 MΩ – 1.0 TΩ). |
| AVG | Additional averaging of the result value (OFF, 5, 10, 30, 60). |

Keys:

| | |
|-------------------|--|
| ▲ ▼ | Selects the field to be changed. |
| ◀ ▶ | Modifies selected field. |
| SELECT | Toggles between graph view and results view. (Graph must be enabled in the Settings menu). |
| MEM | Enters Save custom test menu. Saves results (if present). |
| START/STOP | Starts or Stops the Insulation Resistance Measurement. |
| ESC | Exits to Measurements menu. |

Keys in graph screen – measurement completed:

| | |
|-----|---|
| ◀ ▶ | Scroll the cursor along displayed graph data. |
| ▲ ▼ | Cursors on / off |

Insulation Measurement procedure:

- ❑ Select the **Insulation Resistance Measurement** function.
- ❑ Set the test parameters (voltage, timer, high limit, averaging).
- ❑ Connect the test leads to the instrument and to the test object.
- ❑ Press the **START/STOP** key to start the measurement.
- ❑ Press SELECT key to toggle between graph view and result view (optional).
- ❑ Wait until the test result has stabilized then press the **START/STOP** key again to stop the measurement or wait for the set timer to run out.
- ❑ Wait for the object under test to discharge.
- ❑ Store the result by pressing **MEM** key (optional).

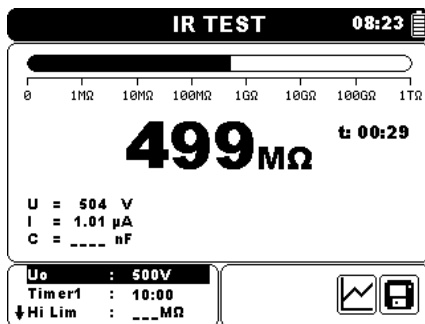

Figure 5.9: Example of Insulation resistance measurement result

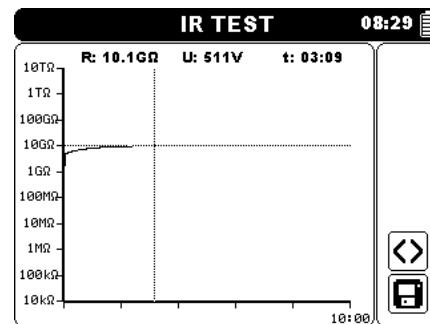

Figure 5.10: Example of Insulation Resistance measurement graph view

Warnings:

- ❑ **Refer to Warnings chapter for safety precautions!**
- ❑ **Do not touch the test object during the measurement or before it is fully discharged! Risk of electric shock!**

Notes:

- ❑ Consider displayed warnings when starting the measurement!
- ❑ A high-voltage warning symbol appears on the display during the measurement to warn the operator of a potentially dangerous test voltage.
- ❑ Value of capacitance is measured during the final discharge of the test object.

5.6.1 Set Limit

With the high limit the user is allowed to set the limit resistance value. Measured resistance is compared against the limit. Result is validated only if it is within the given limit. Limit indication is shown by the bar – graph marker (see Figure 5.10).

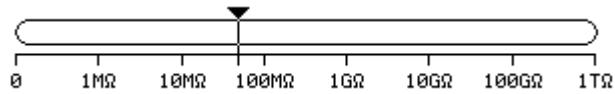

Figure 5.11: Limits marker

Message window:



Measurement result is within defined limit.



Measurement result is out of defined limit.

Note:

- Pass / Fail indication is only displayed if limit is set and if no Break down, Over voltage or Noise is detected during measurement.

5.7 Diagnostic test

Diagnostic test is a long duration test for evaluating the quality of the insulation material under test. The results of this test enable the decision to be made on the preventive replacement of the insulation material. Test can be started from the Diagnostic Test window. Before carrying out a test the parameters can be edited.

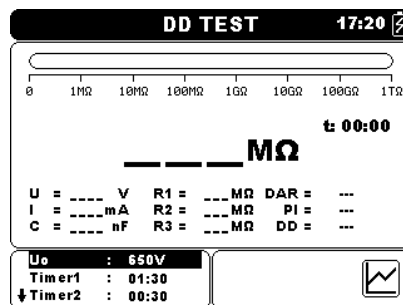

Figure 5.12: Diagnostic test menu

Test parameters for Diagnostic test

| | |
|---------------|--|
| Un | Set test voltage – step 50 V (50 V – 1 kV) and 100 V (1 kV – 5 kV). |
| Timer1 | Delay for starting DAR measurement (mm:ss) – step 1 s (max time 99 min). |
| Timer2 | Delay for starting PI measurement (mm:ss) – step 1 s (max time 99 min). |
| Timer3 | Duration of measurement (mm:ss) – step 1 s (max time 99 min). |
| DD | Enable or disable dielectric discharge testing. |
| AVG | Additional averaging of the result value (OFF, 5, 10, 30, 60). |

Keys:

| | |
|-------------------|--|
| ▲ ▼ | Selects the field to be changed. |
| ◀ ▶ | Modifies selected field. |
| SELECT | Toggles between graph view and results view. (Graph must be enabled in the Settings menu). |
| MEM | Enters Save custom test menu. Saves results (if present). |
| START/STOP | Starts or Stops the Diagnostic Test. |
| ESC | Exits to Measurements menu. |

Keys in graph screen – measurement completed:

| | |
|------------|---|
| ◀ ▶ | Scroll the cursor along displayed graph data. |
| ▲ ▼ | Cursors on / off |

Diagnostic Test procedure:

- ❑ Select the **Diagnostic test** function.
- ❑ Set the test parameters (voltage, timer1 ...).
- ❑ Connect the test leads to the instrument and to the test object.
- ❑ Press the **START/STOP** key to start the measurement.
- ❑ Press SELECT key to toggle between graph view and result view (optional).
- ❑ Wait for the set timers to run out.
- ❑ Wait for the object under test to discharge.
- ❑ Store the result by pressing **MEM** key (optional).

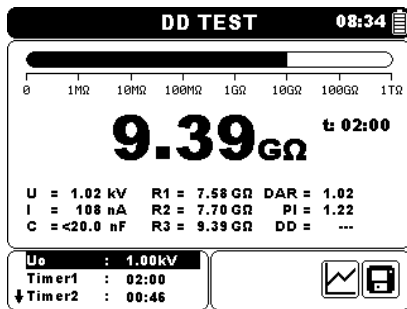

Figure 5.13: Example of Diagnostic test result

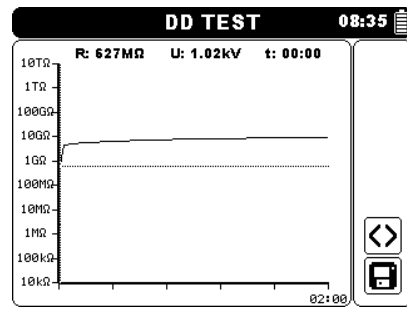
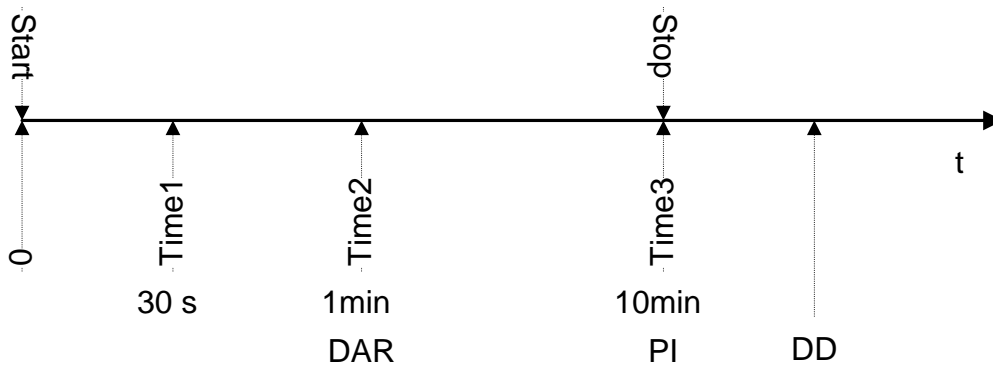

Figure 5.14: Example of Diagnostic test graph view

Timer1, Timer2 and Timer3 are timers with the same starting point. The value of each presents the duration from the start of the measurement. The maximum time is limited to 99 min. The following Figure shows the timer relationships.



Time1 ≤ Time2
 Time2 ≤ Time3

Figure 5.15 Timer relations

5.7.1 Dielectric Absorption Ratio (DAR)

DAR is ratio of Insulation Resistance values measured after 30 s and after 1 minute. The DC test voltage is present during the whole period of the test (also an Insulation Resistance measurement is continually running). At the end, the DAR ratio is displayed:

$$DAR = \frac{R_{iso}(Timer2_ (1\text{ min}))}{R_{iso}(Timer1_ (30\text{ s}))}$$

Some applicable values for DAR (Timer1 = 30 s and Timer2 = 1 min):

| DAR value | Tested material status |
|------------------------|------------------------|
| < 1 | Bad insulation |
| $1 \leq DAR \leq 1.25$ | Acceptable insulation |
| > 1.4 | Very good insulation |

Note:

- When determining R_{iso} (30 s) pay close attention to the capacitance of the test objects. It has to be charged-up in the first time section (30 s). Approximate maximum capacitance using:

$$C_{\max} [\mu F] = \frac{t [s] \times 10^3}{U [V]}$$

Where:

t period of first time unit (e.g. 30 s).

U Test voltage.

5.7.2 Polarization Index (PI)

PI is the ratio of Insulation Resistance values measured after 1 minute and after 10 minutes. The DC test voltage is present during the whole period of the measurement (an Insulation Resistance measurement is also running). On completion of the test the PI ratio is displayed:

$$PI = \frac{R_{iso}(Timer3_ (10\text{ min}))}{R_{iso}(Timer2_ (1\text{ min}))}$$

Some applicable values for PI (Timer2 = 1 min and Timer3 = 10 min):

| PI value | Tested material status |
|----------|---|
| 1 – 1.5 | Not acceptable (older types) |
| 2 – 4 | Considered as good insulation (older types) |
| 4 | Modern type of good insulation systems |

Note:

- When determining Riso (1 min) pay close attention to the capacitance of the test objects. It has to be charged-up in the first time section (1 min). Approximate maximum capacitance using:

$$C_{\max} [\mu F] = \frac{t [s] \times 10^3}{U [V]}$$

where:

t period of first time unit (e.g. 1 min).

U Test voltage.

Analyzing the change in the measured insulation resistance over time and calculating the DAR and PI are very useful maintenance tests of an insulating material.

5.7.3 Dielectric Discharge Testing (DD)

DD is the diagnostic insulation test carried out after the completion of the Insulation Resistance measurement. Typically the insulation material is left connected to the test voltage for 1 ÷ 30 min and then discharged before the DD test is carried out. After 1 minute a discharge current is measured to detect the charge re-absorption of the insulation material. A high re-absorption current indicates contaminated insulation (mainly based on moisture):

$$DD = \frac{I_{dis1\ min} [nA]}{U [V] \times C [\mu F]}$$

where:

I_{dis 1 min} Discharging current measured 1 min after regular discharge.

C Capacitance of test object.

U Test voltage.

A high re-absorption current shows that the insulation has been contaminated, usually by moisture. Typical values of dielectric discharge are shown in table.

| DD value | Tested material status |
|----------|------------------------|
| > 4 | Bad |
| 2 – 4 | Critical |
| < 2 | God |

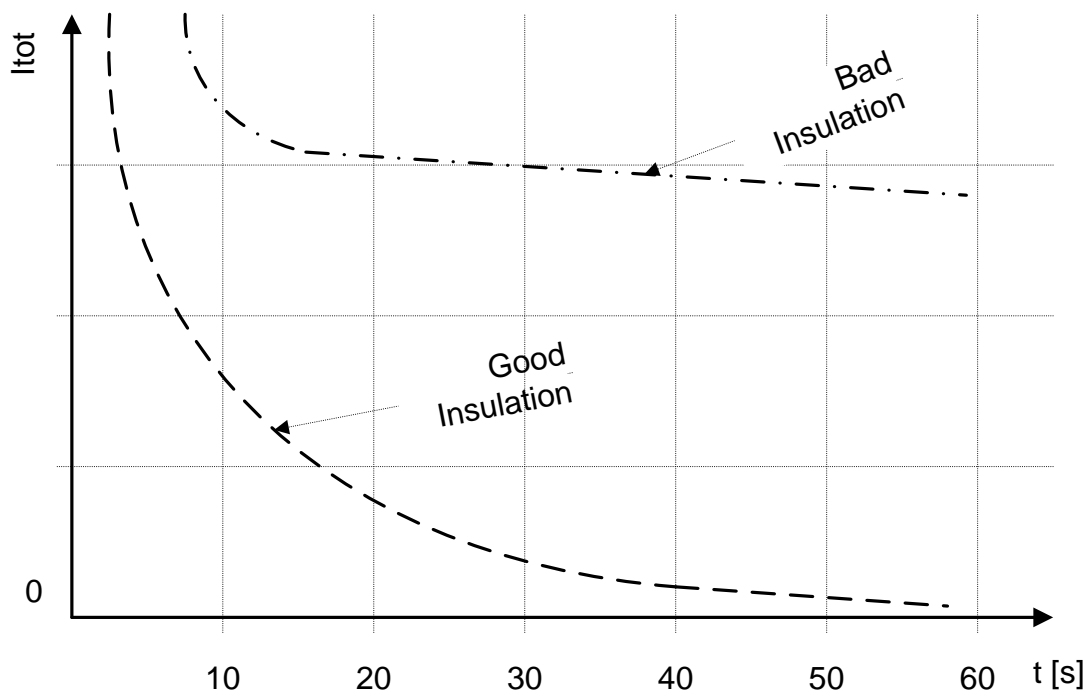

Figure 5.16: The current/time diagram of a good and bad insulation tested with dielectric discharge method

The dielectric discharge test is very useful for testing a multi-layer insulation. This test can identify excess discharge currents that occur when one layer of a multi-layer insulation is damaged or contaminated. This condition will not be detected by both the spot test and the polarization index test. Discharge current will be higher for known voltage and capacitance if an internal layer is damaged. The time constant of this individual layer will differ from other layers, causing a higher current than that of a sound insulation.

Warnings:

- ❑ Refer to Warnings chapter for safety precautions!
- ❑ Do not touch the test object during the measurement or before it is fully discharged! Risk of electric shock!

Notes:

- ❑ Consider displayed warnings when starting the measurement!
- ❑ A high-voltage warning symbol appears on the display during the measurement to warn the operator of a potentially dangerous test voltage.
- ❑ Value of capacitance is measured during the final discharge of the test object.
- ❑ If enabled, the instrument measures Dielectric Discharge (DD) when the capacitance is within the range of 20 nF to 50 μ F.
- ❑ The time duration of Graph R(t) is equal to the value of Timer3.
- ❑ The Timer value could be very long (up to 99 minutes), so the Special automatic decimation algorithm is used to write the Graph R(t) to the LCD.
- ❑ If additional averaging (AVG) of the result value is turned on PI and DAR will not be calculated (---).

5.8 Step Voltage testing

In this test, the insulation is measured in five equal time periods with test voltages from one fifth of the final test voltage up to full scale (Figure 5.17). This function illustrates the relationship of a materials Insulation resistance and its applied voltage.

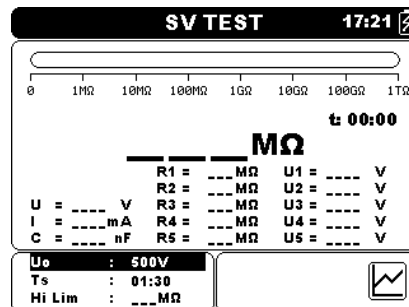

Figure 5.17: Step Voltage Test menu

Test parameters for Step Voltage Test

| | |
|---------------|---|
| Un | Set test voltage – step 50 V (50 V – 1 kV) and 100 V (1 kV – 5 kV). |
| Timer1 | Duration of measurement (mm:ss) – step 1 s (max time 99 min). |
| AVG | Additional averaging of the result value (OFF, 5, 10, 30, 60). |

Keys:

| | |
|-------------------|--|
| ▲ ▼ | Selects the field to be changed. |
| ◀ ▶ | Modifies selected field. |
| SELECT | Toggles between graph view and results view. (Graph must be enabled in the Settings menu). |
| MEM | Enters Save custom test menu. Saves results (if present). |
| START/STOP | Start or Stop the Step Voltage test. |
| ESC | Exits to Measurements menu. |

Keys in graph screen – measurement completed:

| | |
|-----|---|
| ◀ ▶ | Scroll the cursor along displayed graph data. |
| ▲ ▼ | Cursors on / off. |

Step Voltage test procedure:

- Select the **Step Voltage Test** function.
- Set the test parameters (voltage, timer ...).
- Connect the test leads to the instrument and to the test object.
- Press the **START/STOP** key to start the measurement.
- Press **SELECT** key to toggle between graph view and result view (optional).
- Wait for the set timers to run out.
- Wait for the object under test to discharge.
- Store the result by pressing **MEM** key (optional).

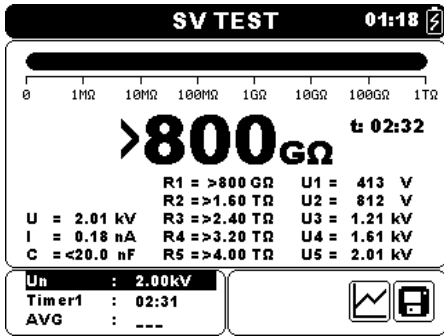

Figure 5.18: Example of Step Voltage test result

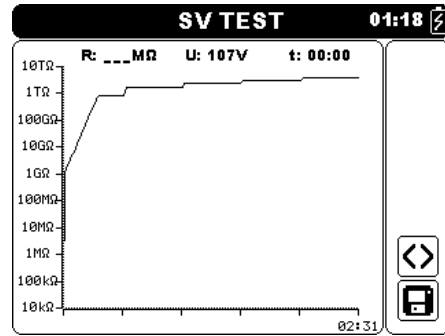

Figure 5.19: Example of Step Voltage test graph view

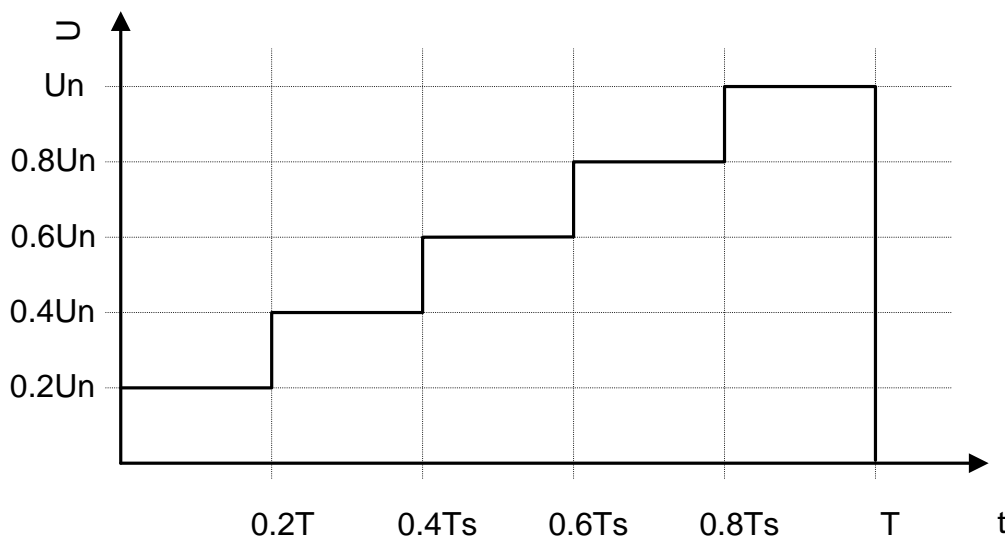

Figure 5.20 Step-up voltage test

Warnings:

- ❑ Refer to Warnings chapter for safety precautions!
- ❑ Do not touch the test object during the measurement or before it is fully discharged! Risk of electric shock!

Notes:

- ❑ Consider displayed warnings when starting the measurement!
- ❑ A high-voltage warning symbol appears on the display during the measurement to warn the operator of a potentially dangerous test voltage.
- ❑ Value of capacitance is measured during the final discharge of the test object.
- ❑ Timer information shows the complete measurement period after the completion of the measurement

5.9 Withstanding Voltage Test

This function offers Withstanding Voltage Test of insulation material. It covers two types of tests:

- Breakdown voltage testing of high voltage device, e.g. transient suppressors.
- DC withstanding voltage test for insulation coordination purposes.

Both functions require breakdown current detection. In the function, the test voltage is increased from the starting voltage to the stop voltage over a predefined time (set by the parameters). The Stop voltage is then maintained for a predefined test time.

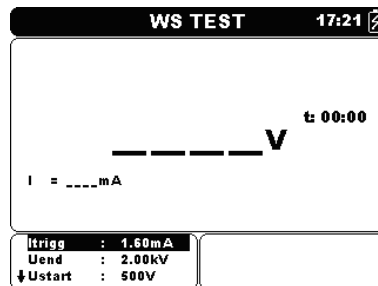

Figure 5.21: Withstanding Voltage Test menu

Test parameters for Withstanding Voltage Test

| | |
|---------------|---|
| Itrigg | Set trigger leakage current step – 100 μ A (max 1.00 mA). |
| Ustart | Stop test voltage – step 50 V (50 V – 1 kV) and 100 V (1 kV – 5 kV). |
| Uend | Start test voltage – step 50 V (50 V – 1 kV) and 100 V (1 kV – 5 kV). |
| Tramp | Duration of the test ramp voltage (mm:ss) – step 1 s (max time 99 min). |
| Tstart | Duration of the start test voltage (mm:ss) – step 1 s (max time 99 min). |
| Tend | Duration of constant test voltage after reaching stop value (mm:ss) – step 1 s (max time 99 min). |

Keys:

| | |
|-------------------|--|
| ▲ ▼ | Selects the field to be changed. |
| ◀ ▶ | Modifies selected field. |
| MEM | Enters Save custom test menu. Saves results (if present). |
| START/STOP | Start or Stop the Withstanding Voltage test. |
| ESC | Exits to Measurements menu. |

Withstanding Voltage test procedure:

- Select the **Withstanding Voltage test** function.
- Set the test parameters (voltage, timer ...).
- Connect the test leads to the instrument and to the test object.
- Press the **START/STOP** key to start the measurement.
- Wait until the set timer runs out or until breakdown occurs, (the result will be displayed).
- Wait for the object under test to discharge.
- Store the result by pressing **MEM** key (optional).

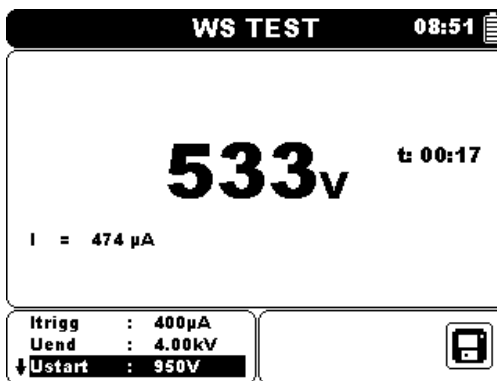

Figure 5.22: Example of Withstanding Voltage test result

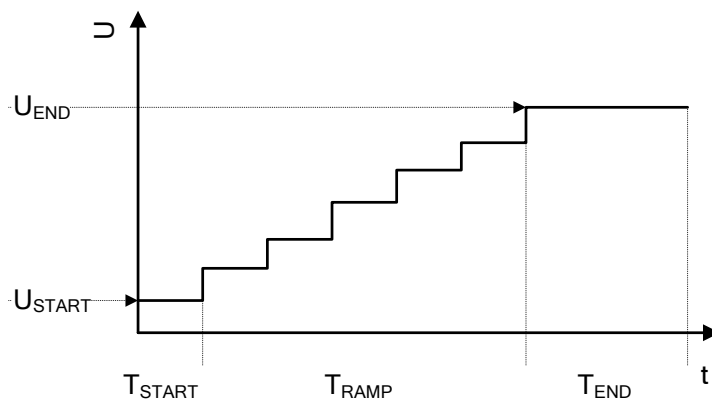

Figure 5.23 Test voltage presentation without breakdown

- U_{START} Starting test voltage.
- U_{END} End test voltage.
- T_{RAMP} Duration of test ramp.
- T_{START} Duration of starting test voltage.
- T_{END} Duration of test voltage after reaching U_{END} value.

Notes:

- ❑ Breakdown is detected when the measured current reaches or exceeds the set current level I_{trigg}.
- ❑ A high-voltage warning symbol appears on the display during the measurement to warn the operator of a potentially dangerous test voltage.

6 Communication

The instrument can communicate with the HVLink PRO PC software. The following action is supported:

- Saved results can be downloaded and stored to a PC.

A special communication program on the PC automatically identifies the instrument and enables data transfer between the instrument and the PC.

There are three communication interfaces available on the instrument: USB, RS 232 or Bluetooth.

How to transfer stored data:

- ❑ RS 232 communication: connect a PC COM port to the instrument RS 232 terminal using the RS 232 serial communication cable.
- ❑ USB communication: connect a PC USB port to the instrument USB connector using the USB interface cable.
- ❑ Switch on the PC and the instrument.
- ❑ Set the desired communication port RS 232, USB or Bluetooth.
- ❑ Run the HVLink PRO PC software.
- ❑ The instrument is prepared to download data to the PC.

Note:

- ❑ USB drivers should be installed on PC before using the USB interface. Refer to USB installation instructions available on installation CD.
- ❑ Bluetooth communication device pairing code NNNN.

7 Maintenance

Unauthorized persons are not allowed to open the TeraOhm XA 5kV instrument. There are no user replaceable components inside the instrument, except the battery.

7.1 Batteries insertion and replacement

Battery is stored in the battery compartment of the instrument casing under the battery cover (see Figure 7.1). In case of defective battery please note the following:

Step 1

Turn off the power, disconnect any measurement accessories and mains supply cable connected to the instrument before opening the battery cover to avoid electric shock.

Step 2

Remove the battery cover (see Figure 7.1) !



Figure 7.1: Battery cover screws

Step 3

Replace the battery of the same type.

Step 4

Insert the battery correctly and check polarity!

Step 5

Fix the battery cover back in place.

Ensure batteries are used and disposed of in accordance with Manufacturers guidelines and in accordance with Local and National Authority guidelines.

Note:

- Operator does not need to disconnect the instrument from mains supply after the full recharging period. The instrument can be connected permanently.

Warnings:

-  **Disconnect all measuring accessory, mains supply and switch off the instrument before opening battery cover!**
- **Use only VB 18650 rechargeable Li-ion battery provided by the manufacturer!**

7.2 Cleaning

No special maintenance is required for the housing. To clean the surface of the instrument use a soft cloth slightly moistened with soapy water or alcohol. Then leave the instrument to dry totally before use.

Warnings:

- ❑ Do not use liquids based on petrol or hydrocarbons!
- ❑ Do not spill cleaning liquid over the instrument!

7.3 Periodic calibration

It is essential that the test instrument is regularly calibrated in order that the technical specification listed in this manual is guaranteed. We recommend an annual calibration. Only an authorized technical person can do the calibration. Please contact your dealer for further information.

7.4 Service

For repairs under warranty, or at any other time, please contact your distributor.

8 Technical specifications

| | |
|--|--|
| Nominal test voltage range | 50 V ÷ 5 kV |
| Voltage step | 50 V (50 V – 1 kV) and 100 V (1 kV ÷ 5 kV) |
| Voltage output accuracy | -0%, +10% ± 10 V @ 100 MΩ load |
| Current capability of test generator | > 1 mA |
| Short circuit / charge current | > 6 mA |
| Charging rate for capacitive load | < 2 s / μF at 5 kV (battery or mains) |
| Automatic discharge | yes |
| Discharging rate for capacitive load | < 0,120 s / μF at 5 kV |
| Discharging resistance | 24,6 kΩ ± 10 % |
| Bar graph range | 0 ÷ 1 TΩ (logarithmic scale) |
| Guard resistance | 400 kΩ ± 5 % |
| Input AC current noise rejection | 1 mA @ 300 V (4 mA max) |
| Additional filtering options | Off, 5s, 10s, 30s, 60s (Moving Average) |

Resistance

| Measuring range (Ω) | Resolution (Ω) | Accuracy |
|---------------------|----------------|-------------------------------|
| 0.01 ÷ 9.99 M | 10 k | ±(5 % of reading + 3 digits) |
| 10.0 ÷ 99.9 M | 100 k | |
| 100 ÷ 999 M | 1 M | |
| 1.00 ÷ 9.99 G | 10 M | |
| 10.0 ÷ 99.9 G | 100 M | |
| 100 ÷ 999 G | 1 G | |
| 1.0 ÷ 9.9 T | 100 G | ±(15 % of reading + 1 digits) |
| 10 ÷ 15 T | 1 T | |

Table 8.1: Resistance measurement ranges and accuracy (5 kV)

Notes:

- Full-scale value of resistance (R_{FS}) depends on nominal test voltage (U_N) and is defined according to the following equation:

$$R_{FS} = 3 \cdot 10^9 [\Omega/V] \cdot U_N [V]$$

- Accuracy versus full-scale resistance is defined in table below:

| Measuring range (Ω) | Accuracy |
|--|-------------------------------|
| $R < \frac{R_{FS}}{15}$ | ±(5 % of reading + 3 digits) |
| $\frac{R_{FS}}{15} \geq R \geq R_{FS}$ | ±(15 % of reading + 1 digits) |

Current

| Measuring range (A) | Resolution (A) | Accuracy |
|---------------------|----------------|--|
| 1.00 ÷ 5.00 m | 10 μ | $\pm(5\% \text{ of reading} + 3 \text{ digits})$ |
| 100 ÷ 999 μ | 1 μ | |
| 10.0 ÷ 99.9 μ | 100 n | |
| 1.00 ÷ 9.99 μ | 10 n | |
| 100 ÷ 999 n | 1 n | |
| 10.0 ÷ 99.9 n | 100 p | |
| 0.00 ÷ 9.99 n | 10 p | $\pm(10\% \text{ of reading} + 0.15 \text{ nA})$ |

Table 8.2: Current measurement ranges and accuracy

Voltage

| Measuring range (V) | Resolution (V) | Accuracy |
|---------------------|----------------|--|
| 0 ÷ 999 | 1 | $\pm(5\% \text{ of reading} + 3 \text{ digits})$ |
| 1.00 ÷ 5.99 k | 10 | |

Table 8.3: Voltage measurement ranges and accuracy

Capacitance

| Measuring range (F) | Resolution (F) | Accuracy |
|---------------------|----------------|--|
| 20 ÷ 999 n | 1 n | $\pm(5\% \text{ of reading} + 3 \text{ digits})$ |
| 1.00 ÷ 9.99 μ | 10 n | |
| 10.0 ÷ 50.0 μ | 100 n | |

Table 8.4: Capacitance measurement ranges and accuracy

Nominal voltage range 500 V ÷ 5 kV

Dielectric absorption ratio DAR

| Display range DAR | Resolution | Accuracy |
|-------------------|------------|--|
| 0.01 ÷ 9.99 | 0.01 | $\pm(5\% \text{ of reading} + 3 \text{ digits})$ |
| 10.0 ÷ 100.0 | 0.1 | |

Table 8.5: DAR display ranges and accuracy

Polarization index PI

| Display range PI | Resolution | Accuracy |
|------------------|------------|--|
| 0.01 ÷ 9.99 | 0.01 | $\pm(5\% \text{ of reading} + 2 \text{ digits})$ |
| 10.0 ÷ 100.0 | 0.1 | |

Table 8.6: PI display ranges and accuracy

Dielectric discharge test DD

| Display range DD | Resolution | Accuracy |
|------------------|------------|------------------------------|
| 0.01 ÷ 9.99 | 0.01 | ±(5 % of reading + 2 digits) |
| 10.0 ÷ 100.0 | 0.1 | |

Table 8.7: DD display ranges and accuracy

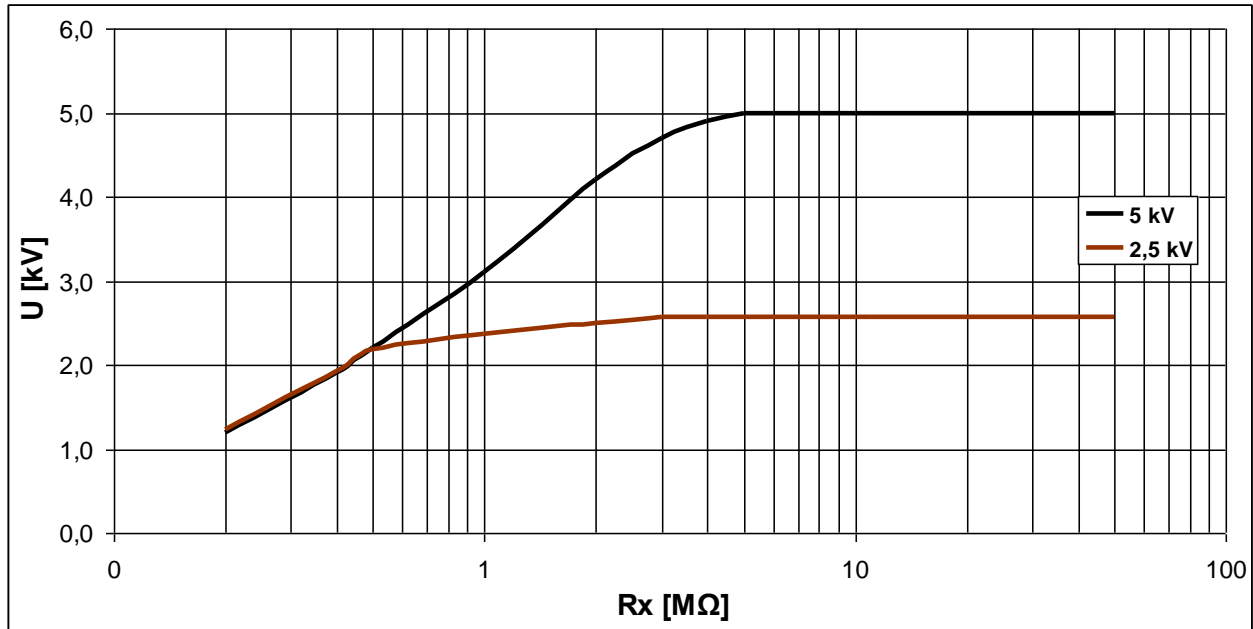



Figure 8.8: Generator capability vs resistance

Notes:

- All data regarding accuracy is given for nominal (reference) environment condition measurements.
- The error in operating conditions could be at most the error for reference conditions (specified in the manual for each function) ±5% of measured value + 3 digits, unless otherwise specified in the manual for particular function.
- Capacitance range for DD test: 20 nF to 50 μF.

8.1 General data

| | |
|-----------------------------------|--|
| Battery power supply | 14.4 V DC (4.4 Ah Li-Ion) |
| Battery charging time | typical 4.5 h (deep discharge) |
| Battery operation time: | |
| Idle state | > 24 h |
| Measurements | > 10 h continues testing 100 MΩ load @ 1 kV |
| | > 7 h continues testing 100 MΩ load @ 5 kV |
| Auto - off timer | 15 min (idle state) |
| Mains power supply | 90-260 V _{AC} , 45-65 Hz, 100 VA (300 V CAT II) |
| Protection classification | reinforced insulation  |
| Over-voltage category | 600 V CAT IV |
| Pollution degree | 2 |
| Degree of protection | IP 65 (case closed), IP 54 (case open) |
| Dimensions (w × h × d) | 36 x 16 x 33 cm |
| Weight | 6.5 kg, (with battery and accessories) |
| Sound / Visual warning | yes |
| Display | 320 x 240 dots matrix display with backlight |
| Reference conditions: | |
| Reference temperature range | 25 °C ± 5 °C |
| Reference humidity range | 40 %RH ÷ 60 %RH |
| Operation conditions: | |
| Working temperature range | -10 °C ÷ 50 °C |
| Maximum relative humidity | 90 %RH (0 °C ÷ 40 °C), non-condensing |
| Working nominal altitude | up to 3000 m |
| Storage conditions: | |
| Temperature range | -10 °C ÷ +70 °C |
| Maximum relative humidity | 90 %RH (-10 °C ÷ +40 °C) |
| | 80 %RH (40 °C ÷ 60 °C) |
| RS 232 serial communication | galvanic separated |
| Baud rate: | 9600 baud rate, 1 stop bit, no parity |
| Connector: | standard RS232 9-pin D female |
| USB slave communication | galvanic separated |
| Baud rate | 9600 baud rate |
| Connector | standard USB connector - type B |
| Bluetooth communication | |
| Device pairing code: | NNNN |
| Baud rate: | 115200 baud rate |
| Memory | 1000 storage locations (4 MB Flash memory) |
| Real time clock error | ± 50 ppm |

Appendix A – Remote Control

Remote Control function is intended for distance control of the instrument MI 3205 TeraOhm XA 5kV via RS232, USB or Bluetooth (optional) communication.

Keypad Driving

All functionalities of the keypad can be driven via Remote Control communication. Table A.1 shows the appropriate syntax to control the instrument keys. When the command is received by the instrument it is send back as acknowledge.

| Keypad | Syntax | Meaning |
|---------------------|--------------------|---|
| START / STOP | ~KEY;START | Start or stop measurement. |
| ON / OFF | ~KEY;OFF | Switches the instrument power off. |
| MEM | ~KEY;MEM | Store / recall / clear tests in memory of the instrument. |
| SELECT | ~KEY;SELECT | To enter set-up mode for the selected function or to select the active parameter to be set. |
| ▲ | ~KEY;UP | Select an option upward, downward. |
| ▼ | ~KEY;DOWN | Select an option upward, downward. |
| ◀ | ~KEY;LEFT | Decrease, increase the selected parameter. |
| ▶ | ~KEY;RIGHT | Decrease, increase the selected parameter. |
| ESC | ~KEY;ESC | Exit the selected mode. |
| ☀ | ~KEY;LIGHT | Turn the display backlight ON or OFF. |

Table A.1: Keypad Driving commands

Test Driving

All stored Custom tests can be run by Remote Control communication. Table A.2 shows the appropriate syntax to start a Custom test. When the command is received by the instrument it is send back as acknowledge.

| Custom tests | Syntax | Meaning |
|--------------|---------------------------------|---------------------------------------|
| CABEL 1kV | ~RUN;CUSTOM;CABEL 1kV | Run selected custom test. |
| 500V TEST | ~RUN;CUSTOM;500V TEST | Run selected custom test. |
| | ~REZIM;PRINT_RESULTS;ON | Enables printing of results (U,I,t). |
| | ~REZIM;PRINT_RESULTS;OFF | Disables printing of results (U,I,t). |

Table A.2: Examples of Custom tests driving commands