



Euro Z 800 V
MI 3144
Instruction manual
Version 1.2.2, Code No. 20 752 881

Distributor:

Manufacturer:

METREL d.d.
Ljubljanska cesta 77
1354 Horjul
Slovenia
web site: <http://www.metrel.si>
e-mail: metrel@metrel.si



Mark on your equipment certifies that it meets requirements of all subjected EU regulations.

© 2019 METREL

The trade names Metrel[®], Smartec[®], Eurotest[®], Auto Sequence[®] are trademarks registered in Europe and other countries.

No part of this publication may be reproduced or utilized in any form or by any means without permission in writing from METREL.

Table of contents

1	General Description	5
1.1	Features	5
2	Safety and operational considerations	6
2.1	Warnings and notes	6
2.2	Battery and charging of Li-ion battery pack	8
2.2.1	Battery indication	8
2.2.2	Charger state	8
2.2.3	Precharge	9
2.2.4	Li – ion battery pack guidelines	10
2.3	Standards applied	11
3	Instrument description	12
3.1	Instrument casing	12
3.2	Operator's panel	12
4	Accessories	13
4.1	Standard set	13
4.2	Optional accessories	13
5	Instrument operation	14
5.1	General meaning of keys	14
5.2	LED indicators	14
5.2.1	Measurement indication	14
5.2.1	Temperature indication	14
5.2.2	Battery indication	14
5.3	Messages on the master instrument	15
5.3.1	Terminal voltage monitor	15
5.4	Operation with the master instrument	16
5.5	Operation with the aMESM	17
6	Tests and Measurements	18
6.1	Impedance Measurements [Z]	18
6.1.1	Z line mΩ Measurement	18
6.1.2	Z loop mΩ Measurement	19
6.1.3	High Current Measurement	20
6.2	DC Source & Line Resistance Measurements [R]	22
6.2.1	R line mΩ Measurement	22
6.3	Earth Potential [U]	24
6.3.1	U touch Measurement	24
6.4	ELR Test [I and t]	25
6.4.1	ELR Current Injection Test	26
6.4.2	ELR Combination Time Test	27
6.5	Current [I]	28
6.5.1	Current Clamp Measurement	28
7	Communication	29
8	Maintenance	30
8.1	Cleaning	30
8.2	Periodic calibration	30
8.3	Service	30

8.4	Upgrading the instrument.....	30
9	Technical specifications.....	31
9.1	Impedance [Z].....	31
9.1.1	Z line mΩ, Z loop mΩ	31
9.1.2	High Current	32
9.1.3	Averaging options.....	32
9.2	DC Source & Line Resistance [R].....	33
9.2.1	R line mΩ.....	33
9.3	Earth Potential [U].....	34
9.3.1	U touch	34
9.4	Sub-results in measurement functions.....	34
9.5	ELR Test [I and t].....	35
9.5.1	ELR Current Injection Test and ELR Combination Time Test.....	35
9.6	Current [I].....	36
9.6.1	Iron (A 1281) and Flex (A 1227, A 1609) current clamp	36
9.7	Test Current.....	37
9.8	General data	38
	Appendix A – Supported Instruments Selection Table.....	39
	Appendix B – MRCD Test (acc.to IEC 60947-2 Annex M)	40
	Appendix C – Short-circuit currents in 3p a.c. systems	44

1 General Description

1.1 Features

Euro Z 800 V (MI 3144) is a Multi-function, portable battery (Li-ion) **or** mains powered test instrument with excellent IP protection: **IP65** (case closed), **IP54** (case opened), intended for: high current line and loop impedance, DC source and line resistance testing, ELR testing and current measurement. It is designed and produced with the extensive knowledge and experience acquired through many years of working in this field.

Available functions and features offered by the **Euro Z 800 V**:

- Impedance measurement up to 800 V;
- CAT IV 600 V measuring category (altitude up to 3000 m);
- Frequency range from 16 Hz up to 420 Hz;
- Selectable test load (16.6 % to 100 %);
- DC source and line resistance measurement up to 260 V;
- Selective loop measurement;
- Current Clamp Measurement (Iron or Flex Clamps);
- ELR Current injection test;
- ELR Combination time test;
- Improved thermal performance;
- Bluetooth communication;
- Black box design (Can be remotely controlled from an Android device)

Two LED bar graph indicators offer easy-to-read battery and thermal condition of the instrument. The operation is straightforward and clear to enable the user to operate the instrument without the need for special training (except reading and understanding this Instruction Manual).

MI 3144 Euro Z 800 V	according to
Z line mΩ Z loop mΩ	EN 61557 – 3 [<i>loop impedance</i>]
High Current	IEEE Std 81 – 2012 [<i>Integrity of ground systems</i>]
U touch	IEEE Std 81 – 2012 [<i>Testing earth potentials and step and touch voltages</i>]
ELR Current Injection Test ELR Combination Time Test	IEC 60947-2 Annex M [<i>Modular residual current devices</i>]

2 Safety and operational considerations

2.1 Warnings and notes

In order to maintain the highest level of operator safety while carrying out various tests and measurements Metrel recommends keeping your **Euro Z 800 V** instruments in good condition and undamaged. When using the instrument, consider the following general warnings:

- The  symbol on the test equipment means »Read the Instruction manual with special care for safe operation«. The symbol requires an action!
- If the test equipment is used in a manner not specified in this Instruction manual, the protection provided by the equipment could be impaired!
- Read this Instruction manual carefully, otherwise the use of the test equipment may be dangerous for the operator, the test equipment itself or for the tested object!
- Do not use the test equipment or any of the accessories if any damage is noticed!
- Regularly check the instrument and accessories for correct functioning to avoid hazard that could occur from misleading results.
- Consider all generally known precautions in order to avoid risk of electric shock while dealing with hazardous voltages! Note that Euro Z 800 V high current impedance adapter is intended for use in environments where dangerous voltages are easy accessible (e.g. switchgears, power stations)!
- Use only standard or optional test accessories supplied by your distributor!
- Do not connect the test equipment to a mains voltage different from the one defined on the label adjacent to the mains connector, otherwise it may be damaged.
- Service intervention, calibration or adjustment is only allowed to be carried out by competent authorized personnel!
- All normal safety precautions must be taken in order to avoid risk of electric shock while working on electrical installations!
- Consider that protection category of some accessories is lower than of the instrument. Test tips have removable caps. If they are removed, the protection falls to CAT II. Check markings on accessories!
 - cap off, 18 mm tip: CAT II up to 1000 V
 - cap on, 4 mm tip: CAT II 1000 V / CAT III 600 V / CAT IV 300 V
- Do not use the equipment in a wet environment, around explosive gas, vapour.
- Only adequately trained and competent persons may operate the equipment.

Markings on the instrument:

Read the Instruction manual with special care to safety operation«. The symbol requires an action!



Front panel can overheat when performing the rapid sequence of high precision line-to-line impedance measurements.



Mark on your equipment certifies that it meets requirements of all subjected EU regulations.



This equipment should be recycled as electronic waste.



This equipment is protected by reinforced insulation.

**Warnings related to measurement functions:**

- Use only standard or optional test accessories supplied by your distributor!
- Always connect accessories to the test equipment and to the test object before starting measurement. Do not touch test leads or crocodile clips during measurement.
- Do not touch any conductive parts of equipment under test during the test, risk of electric shock!
- Do not connect test terminals (C1, P1, P2, C2 and S) to an external voltage higher than 800 V AC (CAT IV environment) and 260 DC to prevent any damage to the test equipment!
- Do not connect live voltage to A 1597 Human body probe.

Z loop mΩ

- The Z loop mΩ impedance function will trip-out the RCD in RCD protected installation that is tested. To prevent the RCD trip-out, make measurements on entry side of the RCD or bypass the RCD but only for test purpose.
- Specified accuracy of tested parameters is valid only if mains voltage is stable during the measurement.

Z line mΩ

- Specified accuracy of tested parameters is valid only if mains voltage is stable during the measurement.

**Warnings related to Batteries:**

- Use only batteries provided by the manufacturer.**
- Never dispose of the batteries in a fire as it may cause them to explode or generate a toxic gas.**
- Do not attempt to disassemble, crush or puncture the batteries in any way.**
- Do not short circuit or reverse polarity the external contacts on a battery.**
- Keep the battery away from children.**
- Avoid exposing the battery to excessive shock/impacts or vibration.**
- Do not use a damaged battery.**
- The Li – ion battery contains safety and protection circuit, which if damaged, may cause the battery to generate heat, rupture or ignite.**
- Do not leave a battery on prolonged charge when not in use.**
- If a battery has leaking fluids, do not touch any fluids.**
- In case of eye contact with fluid, do not rub eyes. Immediately flush eyes thoroughly with water for at least 15 minutes, lifting upper and lower lids, until no evidence of the fluid remains. Seek medical attention.**

2.2 Battery and charging of Li-ion battery pack

The instrument is designed to be powered by rechargeable Li-ion battery pack or with mains supply.

2.2.1 Battery indication

The battery indication indicates the charge condition of battery. Press LED bar graph key for test.

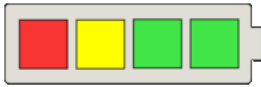

Battery capacity indication (LED bar graph indicator).



2.2.2 Charger state

The battery is charged whenever the power supply is connected to the instrument. The power supply socket is shown in Figure 2.1. Internal circuit controls (CC, CV) charging and assures maximum battery lifetime. Nominal operating time is declared for battery with nominal capacity of 4.4 Ah.



Figure 2.1: Power supply socket (C7)

The instrument automatically recognizes the connected power supply and begins charging.

Description	 Yellow LED	 Green LED
Charging in progress (if power supply adapter is connected and battery inserted).	On	Undefined
Charger complete (battery is full).	Off	On
Charger disconnected. (Battery operating instrument) Sleep mode.	Off	Off
Charger suspend. Battery fault indication (timer fault, battery absent, temperature).	Blinking	Undefined

Battery and charging characteristic	Typical
Battery type	VB 18650
Charging mode	CC / CV
Nominal voltage	7,2 V
Rated capacity	4,4 Ah
Max charging voltage	8,0 V
Max charging current	2,2 A
Max discharge current	2,5 A
Typical charging time	3 hours

Typical charging profile which is also used in this instrument is shown in **Figure 2.2**.

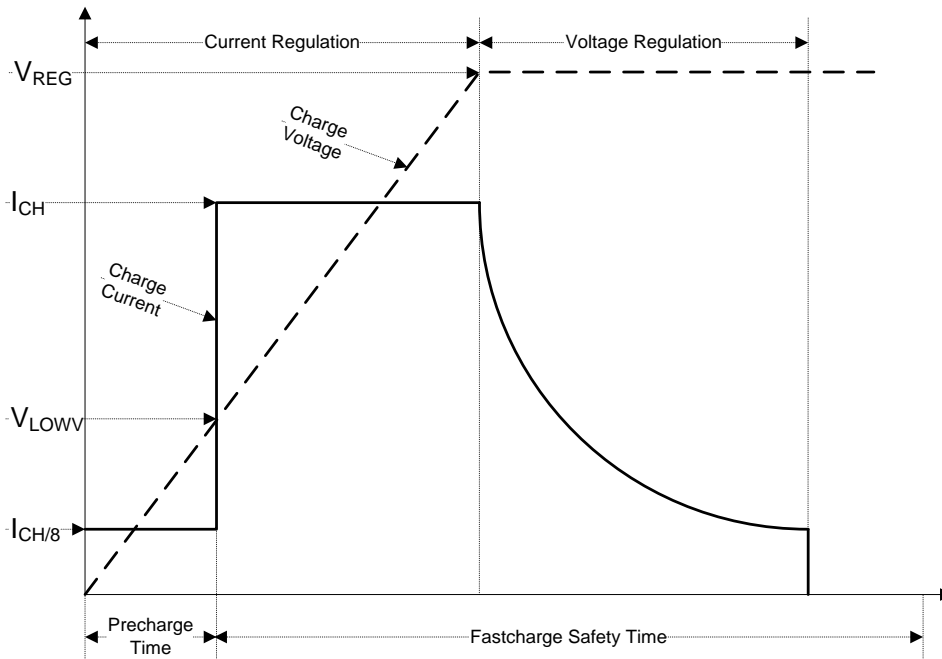

Figure 2.2: Typical charging profile

where:

- V_{REG} Battery charging voltage
- V_{LOWV} Precharge threshold voltage
- I_{CH} Battery charging current
- $I_{CH/8}$ 1/8 of the charging current

2.2.3 Precharge

On power up, if the battery voltage is below the V_{LOWV} threshold, the charger applies 1/8 of the charging current to the battery. The precharge feature is intended to revive deeply discharged battery. If the V_{LOWV} threshold is not reached within 30 minutes of initiating precharge, the charger turns off and a FAULT is indicated.

Note:

- As a safety backup, the charger also provides an internal 5-hour charge timer for fast charge.

Typical charging time is 3 hours in the temperature range of 5°C to 60°C.

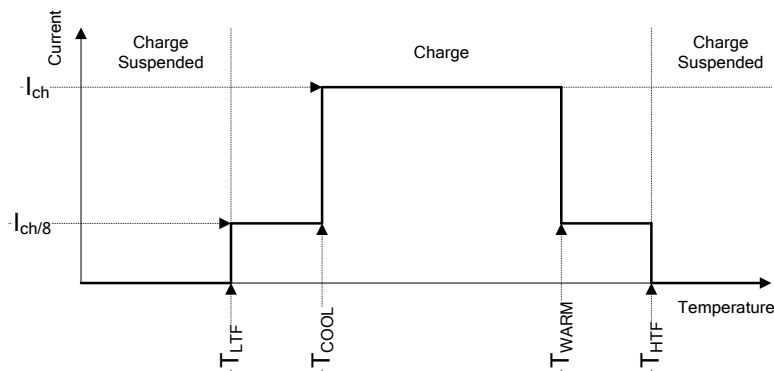

Figure 2.3: Typical charging current vs temperature profile

where:

T_{LTF}	Cold temperature threshold (typ. -15°C)
T_{COOL}	Cool temperature threshold (typ. 0°C)
T_{WARM}	Warm temperature threshold (typ. $+60^{\circ}\text{C}$)
T_{HTF}	Hot temperature threshold (typ. $+75^{\circ}\text{C}$)

The charger continuously monitors battery temperature. To initiate a charge cycle, the battery temperature must be within the T_{LTF} to T_{HTF} thresholds. If battery temperature is outside of this range, the controller suspends charge and waits until the battery temperature is within the T_{LTF} to T_{HTF} range.

If the battery temperature is between the T_{LTF} and T_{COOL} thresholds or between the T_{WARM} and T_{HTW} thresholds, charge is automatically reduced to $I_{CH/8}$ (1/8 of the charging current).

2.2.4 Li – ion battery pack guidelines

Li – ion rechargeable battery pack requires routine maintenance and care in their use and handling. Read and follow the guidelines in this Instruction manual to safely use Li – ion battery pack and achieve the maximum battery life cycles.

Do not leave batteries unused for extended periods of time – more than 6 months (self – discharge).

When a battery has been unused for 6 months, check the charge status; see chapter 5.2.2 *Battery indication*. Rechargeable Li – ion battery pack has a limited life and will gradually lose their capacity to hold a charge. As the battery loses capacity, the length of time it will power the product decreases.

Storage:

- Charge or discharge the instruments battery pack to approximately 50% of capacity before storage.
- Charge the instrument battery pack to approximately 50% of capacity at least once every 6 months.

Transportation:

- Always check all applicable local, national, and international regulations before transporting a Li – ion battery pack.



Handling Warnings:

- Do not disassemble, crush, or puncture a battery in any way.
- Do not short circuit or reverse polarity the external contacts on a battery.
- Do not dispose of a battery in fire or water.
- Keep the battery away from children.
- Avoid exposing the battery to excessive shock/impacts or vibration.
- Do not use a damaged battery.
- The Li – ion battery contains safety and protection circuit, which if damaged, may cause the battery to generate heat, rupture or ignite.
- Do not leave a battery on prolonged charge when not in use.
- If a battery has leaking fluids, do not touch any fluids.
- In case of eye contact with fluid, do not rub eyes. Immediately flush eyes thoroughly with water for at least 15 minutes, lifting upper and lower lids, until no evidence of the fluid remains. Seek medical attention.

2.3 Standards applied

The Euro Z 800 V instrument is manufactured and tested in accordance with the following regulations:

Electromagnetic compatibility (EMC)

EN 61326 Electrical equipment for measurement, control and laboratory use – EMC requirements Class A

Safety (LVD)

EN 61010 - 1 Safety requirements for electrical equipment for measurement, control and laboratory use – Part 1: General requirements

EN 61010 - 2 - 030 Safety requirements for electrical equipment for measurement, control and laboratory use – Part 2-030: Particular requirements for testing and measuring circuits

EN 61010 - 031 Safety requirements for hand-held probe assemblies for electrical measurement and test.

EN 61010 - 2 - 032 Safety requirements for electrical equipment for measurement, control, and laboratory use – Part 2-032: Particular requirements for hand-held and hand-manipulated current sensors for electrical test and measurement

Some further recommendations

EN 61557 Electrical safety in low voltage distribution systems up to 1000 V a.c. and 1500 V d.c. - Equipment for testing, measuring or monitoring of protective measures.

Part 1: General requirements

Part 3: Loop resistance

IEEE 81 – 2012 IEEE Guide for Measuring Earth Resistivity, Ground Impedance, and Earth Surface Potentials of a Grounding System.

EN 60947-2 Low-voltage switchgear and controlgear – Part 2: Circuit-breakers – Annex M Modular residual current devices (without integral current breaking device)

EN 60909 - 0 Short-circuit currents in three-phase a.c.systems – Part 0: Calculation of currents

Li – ion battery pack

EN 62133 - 2 Secondary cells and batteries containing alkaline or other non-acid electrolytes - Safety requirements for portable sealed secondary cells and for batteries made from them, for use in portable applications – Part 2: Lithium systems

Note about EN and IEC standards:

- Text of this manual contains references to European standards. All standards of EN 6XXXX (e.g. EN 61010) series are equivalent to IEC standards with the same number (e.g. IEC 61010) and differ only in amended parts required by European harmonization procedure.

3 Instrument description

3.1 Instrument casing

The instrument is housed in a plastic box that maintains the protection class defined in the general specifications.

3.2 Operator's panel

The operator's panel is shown in Figure 3.1 below.

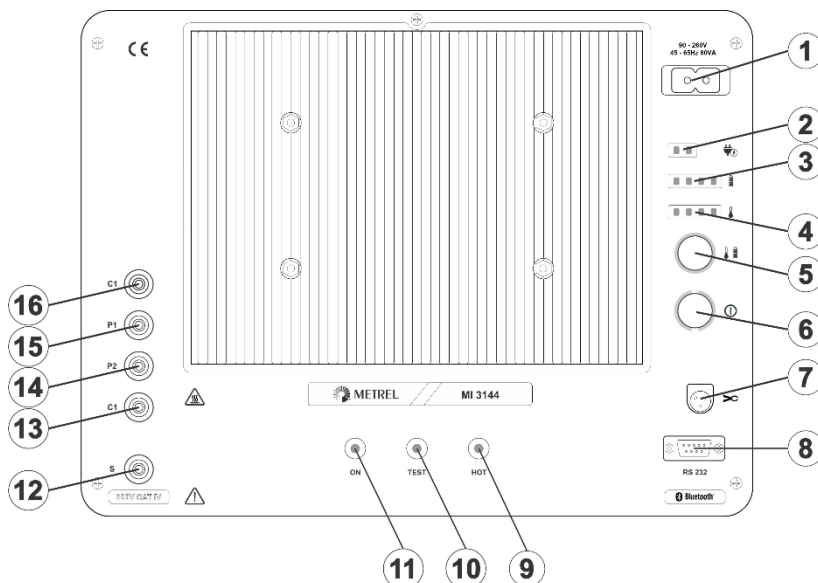

Figure 3.1: The operator's panel

1		Input power supply (charger) socket (type C7).
2		Charger status (green and yellow LED indicators).
3		Battery status (LED bar graph).
4		Temperature status (LED bar graph).
5		LED bar graph key (active if pressed).
6	On/Off	Switch the instrument power on or off. Instrument hard reset (if hold for 10 s or more).
7	Clamp	Clamp input terminal (Only for connection of Metrel Smart clamps).
8	RS232	RS232 communication port.
9	HOT	Instrument overheated.
10	TEST	Measurement status.
11	ON	Power indication.
12 - 16	S, C1, P1, P2, C2	Measuring terminals.

Warnings!

- ❑ Do not connect test terminals (C1, P1, P2, C2) to an external voltage higher than 800 V AC (CAT IV environment) or 260 V DC to prevent any damage to the test equipment!
- ❑ Use original test accessories only!

4 Accessories

The accessories consist of standard and optional accessories. Optional accessories can be delivered upon request. See *attached* list for standard configuration and options or contact your distributor or see the METREL home page: <http://www.metrel.si>.

4.1 Standard set

- ❑ Instrument MI 3144 Euro Z 800 V
- ❑ Large Kelvin test clips (A 1593), 2 pcs
- ❑ Test lead 5 m, 2 pcs (black/red)
- ❑ Test tip, 2 pcs (red)
- ❑ Test tip, 2 pcs (black)
- ❑ Test lead 5 m, 2 pcs (green)
- ❑ G clamp, 1 pc
- ❑ Crocodile clips, 2 pcs (black)
- ❑ RS232 cable (9 pin - PS2)
- ❑ Mains cable
- ❑ Bag for accessories
- ❑ Instruction manual
- ❑ Calibration certificate

4.2 Optional accessories

See the attached sheet for a list of optional accessories and licence keys that are available on request from your distributor.

5 Instrument operation

According to principle, the instrument offers remote control from METREL instruments whose test functions are implemented by application of the Euro Z.

5.1 General meaning of keys



LED bar graph key is used to:

- Power up the temperature and battery bar graph indication;

ON / OFF key:







- Switches the instrument power on or off;
- Instrument hard reset (hold key for 10 s or more).

The instrument automatically turns off 10 minutes after the last key was pressed and no communication with the master instrument or app.

5.2 LED indicators

5.2.1 Measurement indication

LED	Status	Description
 ON	ON	Power indication.
	Blinking	Low battery.
 TEST	ON	Measurement status. <i>LED is activated while measurement is running.</i>
 HOT	Blinking	Overheated. <i>Temperature of internal components in the Euro Z instrument reached top limit. The measurement is prohibited until temperature drops below the limit.</i>
 ON TEST HOT	Blinking	Hardware error. (Input relay failure detected.) <i>Measurements are prohibited! Service intervention is required!</i>

5.2.1 Temperature indication

The temperature indicates the condition of the loading resistor.



Temperature indication (LED bar graph indicator).
Cool, Mild, Warm, Hot

5.2.2 Battery indication

The battery indication indicates the charge condition of battery.



Battery capacity indication (LED bar graph indicator).
Low, Middle, Good, Full

5.3 Messages on the master instrument

Warning!

Low battery on the Euro Z adapter.

Select **OK** for acknowledgement; connect power supply to the Euro Z instrument and recharge the batteries.

Warning!

Euro Z adapter is overheated. The measurement is prohibited until the temperature decreases under the allowed limit.

Select **OK** for acknowledgement; cool down the Euro Z instrument.

Warning!

Wrong voltage system or nominal mains voltage out of range!

Select **OK** for acknowledgement; limit [$40\text{ V} \leq U_{ac} \leq 800\text{ V}$].

Warning!

Wrong frequency system!

Select **OK** for acknowledgement; limit [$16\text{ Hz} \leq f \leq 420\text{ Hz}$].

Warning!

Wrong voltage system, voltage out of range or wrong polarity +, - !

Select **OK** for acknowledgement; limit [$3\text{ V} \leq U_{dc} \leq 260\text{ V}$].

Error!

Connection! Check the correct terminals connection (C1, P1, P2, C2)!
See help for more information.

Select **OK** for acknowledgement.

Error!

Hardware Error!
The measurement is prohibited.

Select **OK** for acknowledgement; Input relay failure detected. Service intervention is required.

5.3.1 Terminal voltage monitor

The terminal voltage monitor displays on-line voltages and frequency on the test terminals.

Up1p2 RMS voltage across P1 – P2 measuring terminals.

Uc1c2 RMS voltage across C1 – C2 measuring terminals.

Freq RMS frequency across C1 – C2 measuring terminals.

5.4 Operation with the master instrument

(e.g. MI 3155 EurotestXD, MI 3152 EurotestXC)

Applied functions

See *Appendix A – Supported Instruments Selection Table* for more information.

Connection with the master instrument (RS232 or Bluetooth)

- For RS 232 communication, connect serial communication interface cable RS 232_9pin_female / PS 2 to the master instrument and the Euro Z instrument. See *Figure 5.1*.

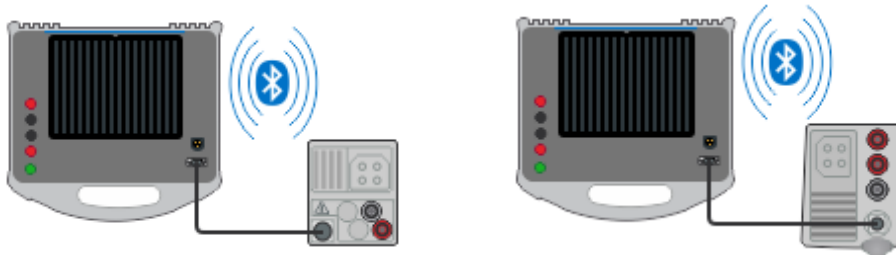

Figure 5.1: Connection of the Euro Z 800 V to the master instrument using RS 232 or Bluetooth (Example of MI 3152 and MI 3155)

- Power on the master instrument and the Euro Z instrument.
- Select the communication port RS 232 or Bluetooth on the master instrument.

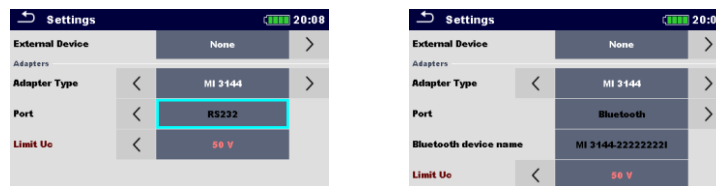

Figure 5.2: Master instrument Setting menu

- Set (pair) the appropriate Bluetooth device from a list of detected Bluetooth devices. The correct name consists of the instrument type plus serial number, e.g. *MI 3144-12345678I*.
- Select measurement function on the master instrument from the EURO Z group.
- The master instrument recognizes the Euro Z instrument in the measurement window by activating terminal voltage monitor and with Bluetooth indication (if Bluetooth communication is set).



Figure 5.3: Terminal voltage monitor – activated and not activated

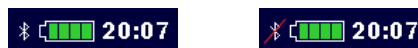

Figure 5.4: Bluetooth indication - connected and disconnected

- Select the proper parameters and limits of the selected measurement on the master instrument.
- Connect the Euro Z instrument to the test object. (Check terminal voltage monitor for proper connection. Use help screens on master instrument if necessary.)
- Press TEST/ RUN/ ENTER key on the master instrument to measure.
- Result of measurement is displayed on the master instrument.

5.5 Operation with the aMESM

Applied functions

See *Appendix A – Supported Instruments Selection Table* for more information.

Connection with aMESM (Bluetooth)

- ❑ Power on the Euro Z instrument and the tablet or smart phone.
- ❑ Enable the Bluetooth hardware on the tablet or smart phone device.
- ❑ Run aMESM application on the tablet or smart phone device.



Figure 5.5: Connection of the Euro Z 800 V to the aMESM

- ❑ Search for the appropriate device (your Euro Z instrument) in the Bluetooth menu and connect to it. The correct name consists of the instrument type plus serial number, e.g. *MI 3144-12345678I*.
- ❑ **Bluetooth communication device pairing code is 1234.**
- ❑ Select measurement function on the aMESM.
- ❑ Select the proper parameters and limits.
- ❑ Connect the Euro Z instrument to the test object.
- ❑ Press the START key on the aMESM application to measure.
- ❑ Result of a measurement is displayed on the aMESM application.

6 Tests and Measurements

The MI 3144 Euro Z 800 V instrument is able to carry out different measurement methods. The operator can select the appropriate one.

6.1 Impedance Measurements [Z]

When performing measurements close to the power transformer or inductance is present, inductive part of impedance has a significant influence to prospective fault/short-circuit current. Therefore, impedance has to be measured (instead of resistance) for correct calculation of prospective fault/short-circuit current.

AC Impedance	Measurement	Test Mode	Test Method	Limit
Z	Z line mΩ	single	4-wire	yes
	Z loop mΩ	single	4-wire	yes
	High Current	single	4-wire + clamp	yes

High precision line and fault loop impedance measurements are performed using high current impulses to assure adequate voltage drop during the test.

Warnings:

- ❑ The Euro Z instrument applies very high loading current into tested installation and it is recommended to make rare measurements, typically one per 15 s to reduce problems caused by such current.
- ❑ Flickers can be observed due to high test current pulses.



6.1.1 Z line mΩ Measurement

Line impedance is the impedance within the current loop when a short-circuit occurs:

- ❑ Conductive connection between phase conductor and neutral conductor in single-phase system,
- ❑ Between two line conductors in three-phase system.

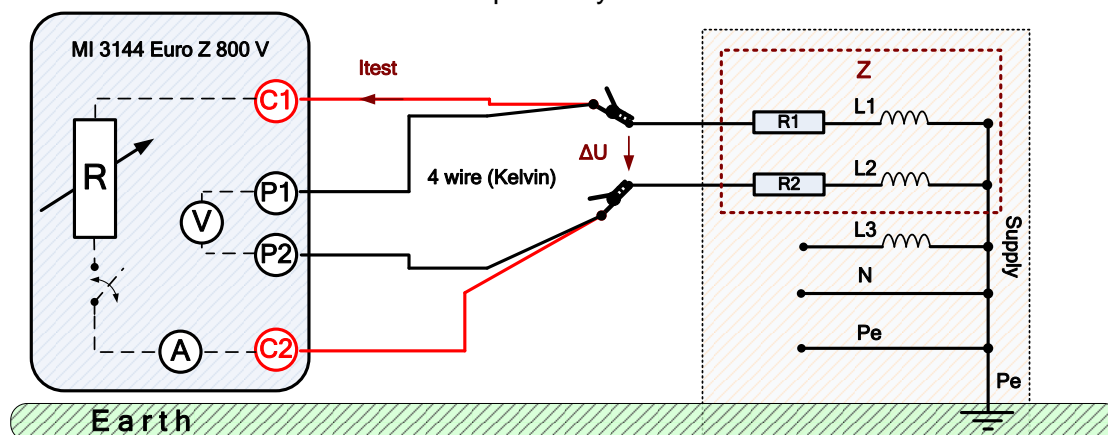

Figure 6.1: Z line mΩ measurement example

During the measurement, an internal resistance is connected between C1 and C2 for a period of a half cycle. The instrument internal shunt resistor measures the current (I_{test}). A voltmeter measures the open circuit voltage with no load (U_{UNLOADED}), followed by the second reading with a load (U_{LOADED}). The impedance Z is determined from the voltage dip / current ratio. In the example, following impedance is measured:

$$Z = \frac{U_{UNLOADED} - U_{LOADED}}{I_{test}} = \frac{\Delta U}{I_{test}}$$

where:

- Z..... Impedance
- $U_{UNLOADED}$ Measured voltage [no load]
- U_{LOADED} Measured voltage [with load]
- ΔU Voltage dip
- I_{test} Test current

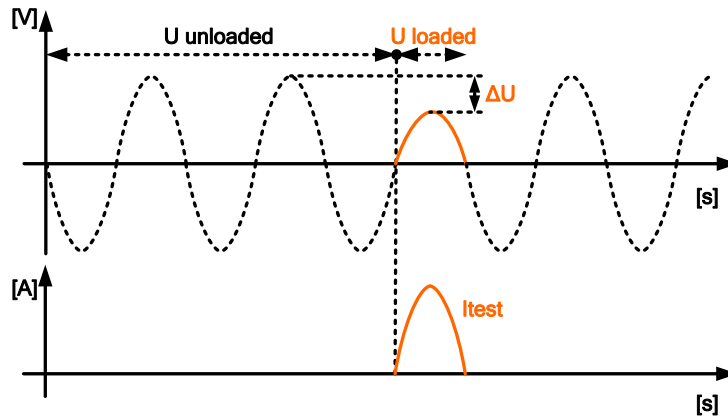

Figure 6.2: Z line mΩ measurement voltage and current waveforms examples



6.1.2 Z loop mΩ Measurement

Loop impedance is the impedance within the fault loop when a short-circuit to exposed conductive parts occurs (conductive connection between phase conductor and protective earth conductor).

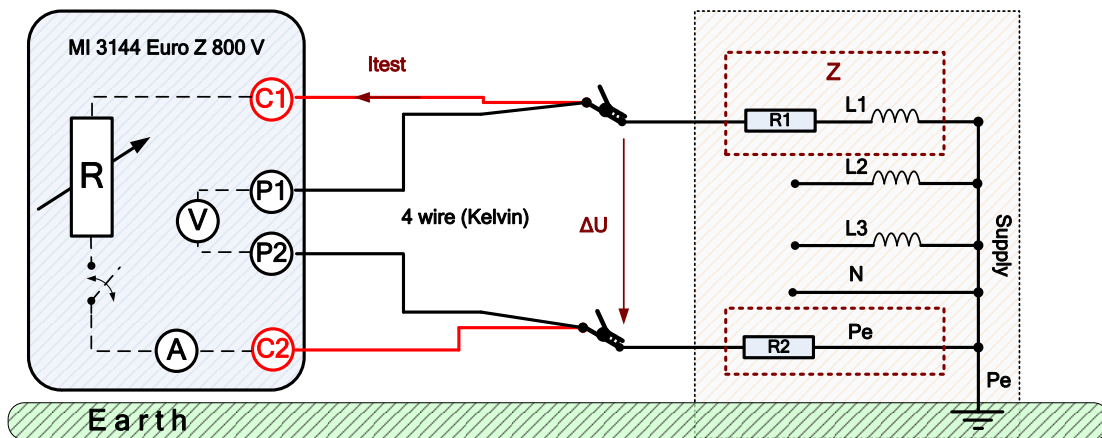

Figure 6.3: Z loop mΩ measurement example

During the measurement, an internal resistance is connected between C1 and C2 for a period of a half cycle. The instrument internal shunt resistor measures the current (I_{test}). A voltmeter measures the open circuit voltage with no load ($U_{UNLOADED}$), followed by the second reading with a load (U_{LOADED}). The impedance Z is determined from the voltage dip / current ratio. In the example, following impedance is measured:

$$Z = \frac{U_{UNLOADED} - U_{LOADED}}{I_{test}} = \frac{\Delta U}{I_{test}}$$

where:

- Z..... Impedance
- $U_{UNLOADED}$ Measured voltage [no load]
- U_{LOADED} Measured voltage [with load]
- ΔU Voltage dip
- I_{test} Test current

ΔR300A
High Current

6.1.3 High Current Measurement

The measurement can be applied for measuring contact resistance (bad contacts) in a live distribution board or fuse box. With test currents from 10 A and all the way to the 100 A, depending on the mains voltage and test load parameter. For more information, see chapter 9.7 Test Current.

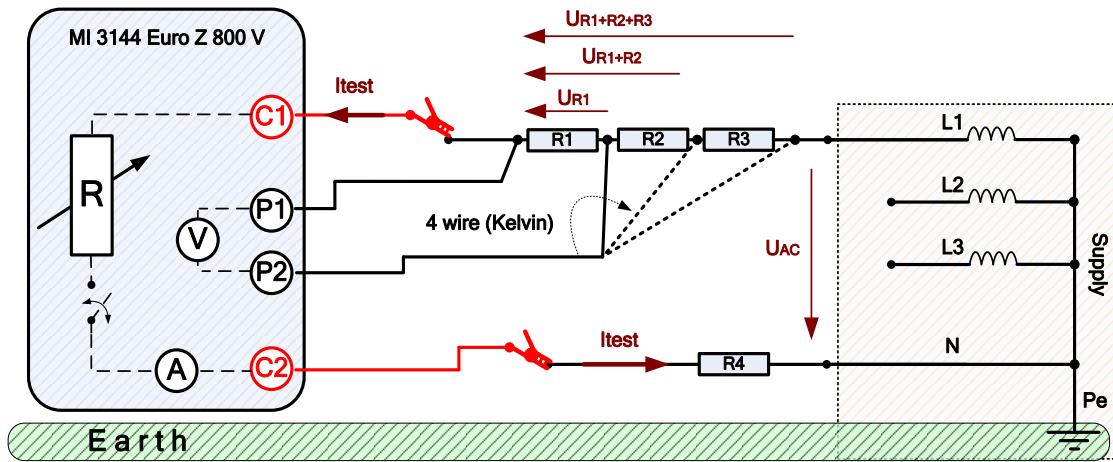

Figure 6.4: High Current Measurement example 1 (distribution board)

Proposed measurement can be referenced to standard IEEE-81 par. 10.2 and 10.3.

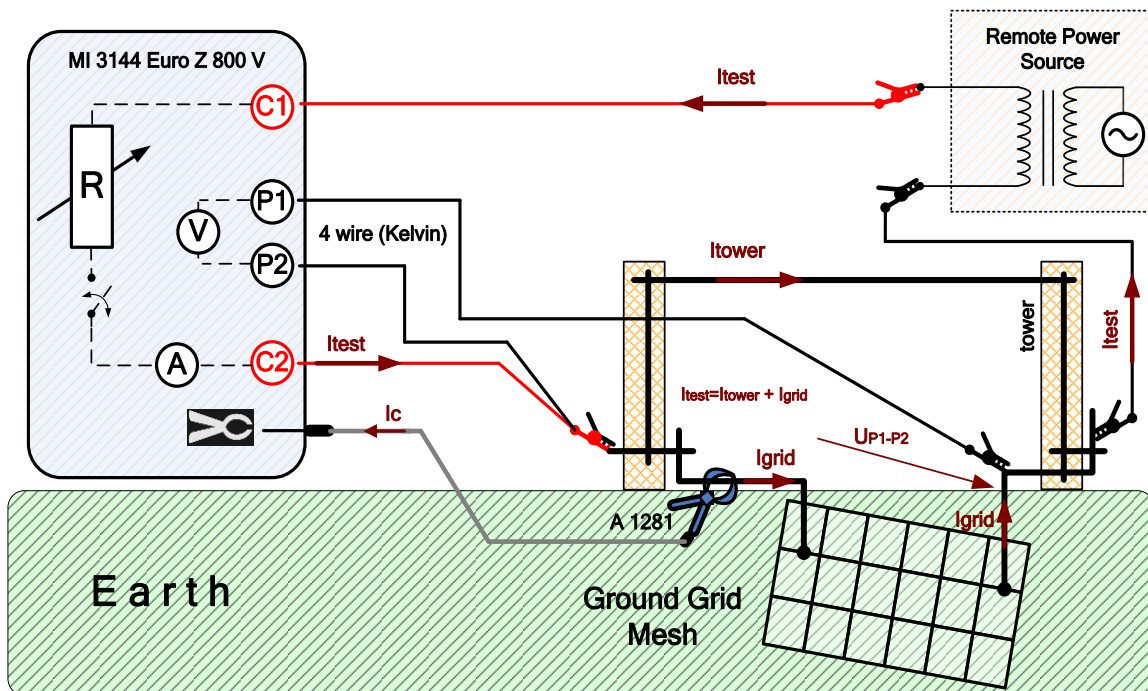

Figure 6.5: High Current Measurement example 2 (IEEE-81)

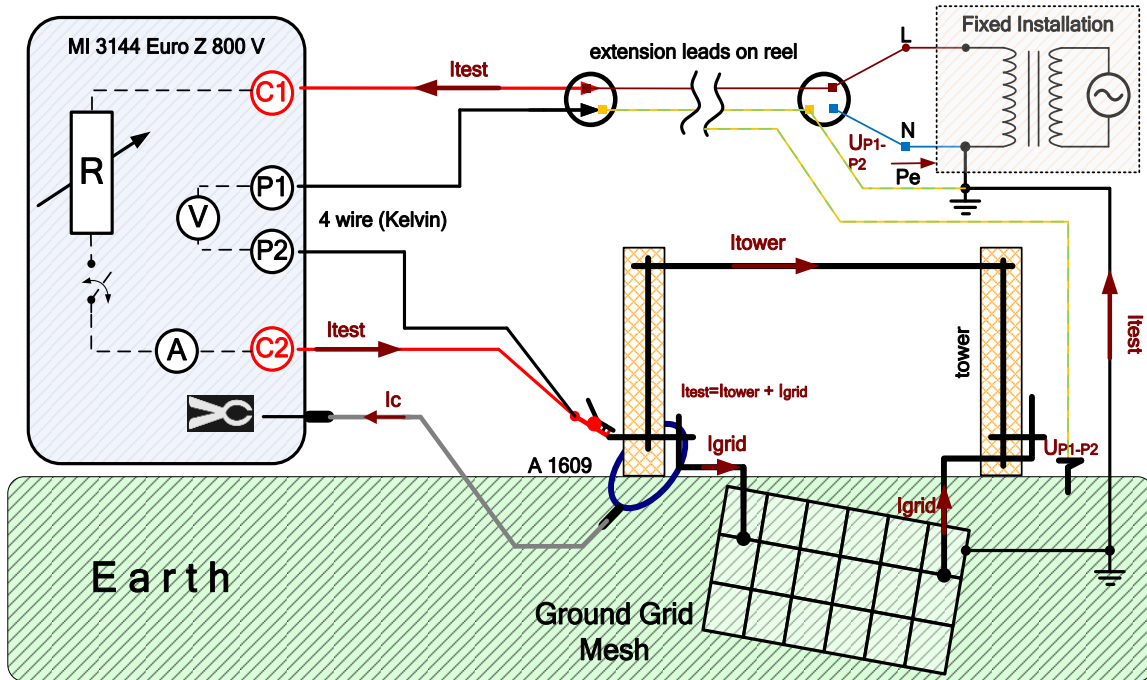

Figure 6.6: High Current Measurement example 3 (IEEE-81)

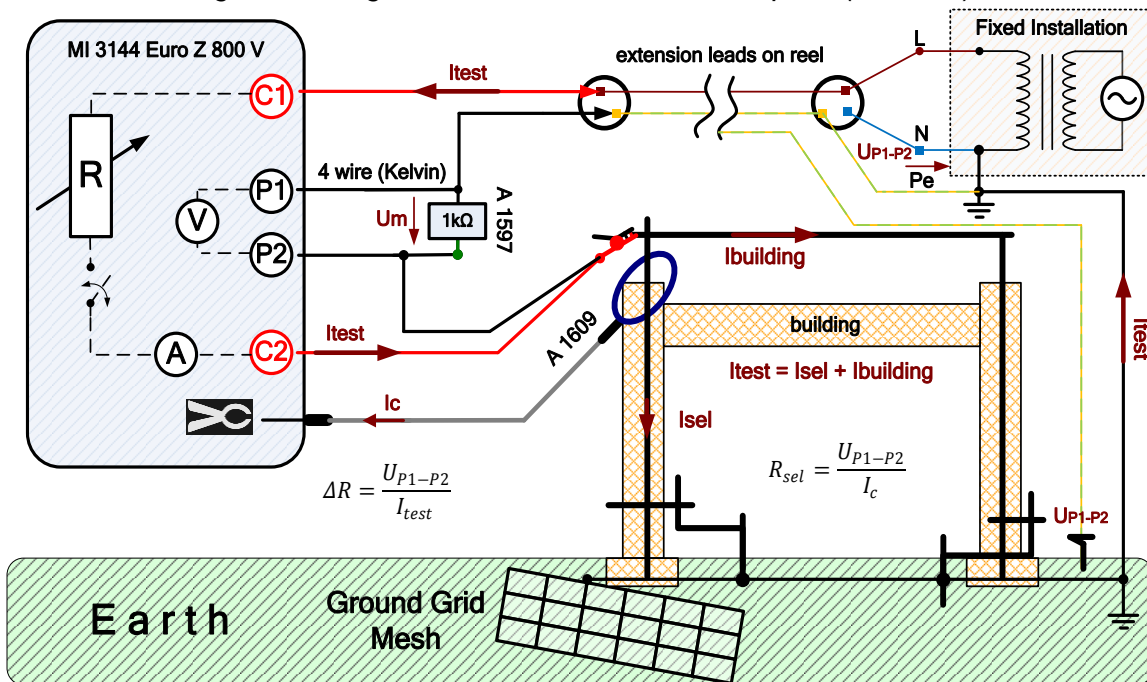

Figure 6.7: High Current Measurement example 4 (IEEE-81)

During the measurement, an internal resistance is connected between C1 and C2 for a period of a half cycle. The current is measured by the Euro Z instrument (I_{test}) and optionally by the clamp current (I_c). The supply network and test load setting determines the current amplitude. A higher current amplitude improves the immunity against voltage noise. Potential probes P1 and P2 measure the voltage dip. The resistance R is determined from the voltage / current ratio and the selective resistance (R_{sel}) is determined from the voltage / clamp current ratio.

In the example, following resistance and selective resistance is measured:

$$\Delta R = \frac{U_{P1-P2}}{I_{test}} \qquad R_{sel} = \frac{U_{P1-P2}}{I_c}$$

where:

- ΔR Resistance
- R_{sel} Selected resistance
- U_{P1-P2} Voltage dip [with load]
- I_{test} Test current
- I_c Clamp current

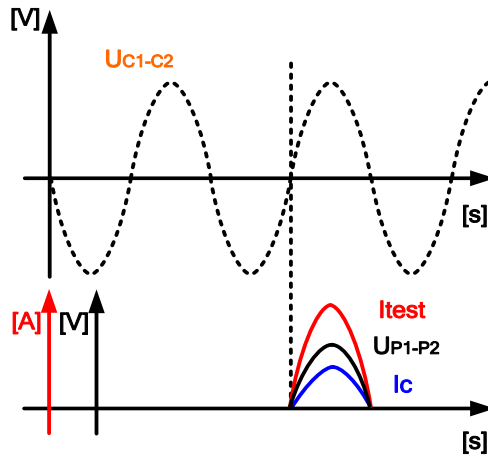

Figure 6.8: High Current measurement voltage and current waveforms examples

6.2 DC Source & Line Resistance Measurements [R]

DC Resistance	Measurement	Test Mode	Test Method	Limit
R	R line mΩ	single	4-wire	yes

Table 6.9: Available DC Resistance measurements in the MI 3144



6.2.1 R line mΩ Measurement

R line mΩ measurement is intended for checking the internal resistance of larger batteries (fully charged) or for checking DC installations up to 260 Vdc.

The battery or dc voltage source receives a short discharge. The discharge current is set according to the value of the applied DC voltage source ($U_{DC_UNLOADED}$) and max power of the internal load.

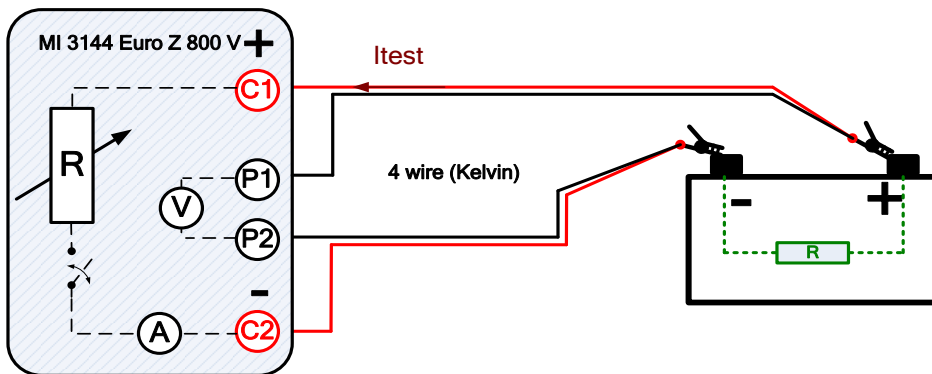

Figure 6.10: R line mΩ Measurement example 1 (battery)

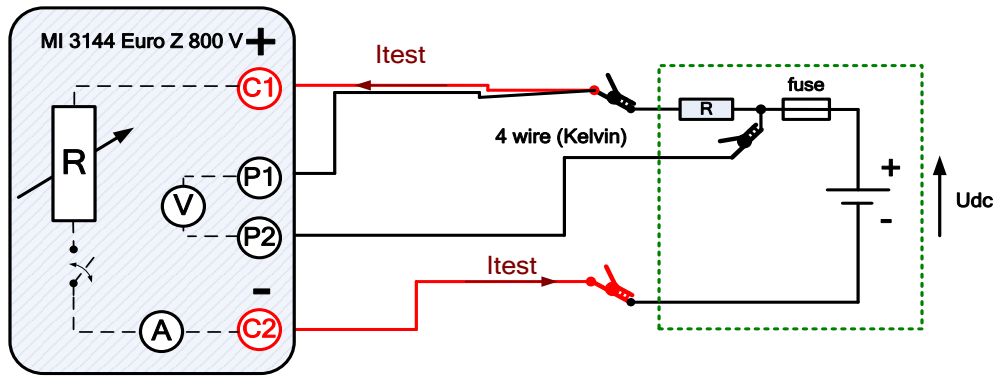

Figure 6.11: R line mΩ Measurement example 2 (DC installation)

During the measurement, an active internal resistance is connected between C1 (+) and C2 (-) for 20 ms. The instrument internal shunt resistor measures the current (I_{test}). A voltmeter measures the open circuit voltage with no load ($U_{DC_UNLOADED}$), followed by the second reading with a load (U_{DC_LOADED}). The resistance R is determined from the voltage dip / current ratio. In the example, following resistance is measured:

$$R = \frac{U_{DC_UNLOADED} - U_{DC_LOADED}}{I_{test}} = \frac{\Delta U}{I_{test}}$$

where:

- R Resistance
- $U_{DC_UNLOADED}$ Measured DC voltage [no load]
- U_{DC_LOADED} Measured DC voltage [with load]
- ΔU Voltage dip
- $\Delta U\%$ Voltage dip in percentage [$\Delta U (\%) = [(\Delta U / U_{DC_UNLOADED}) \times 100 \%$]
- I_{test} Test current

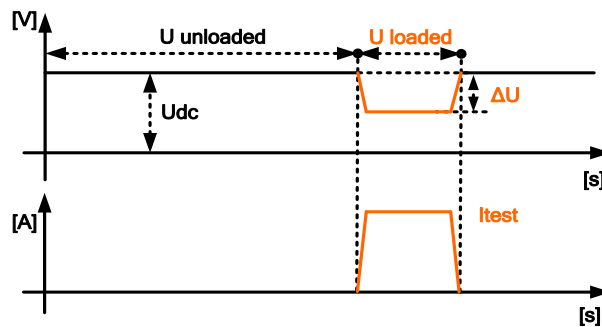

Figure 6.12: R line mΩ measurement - voltage and current waveforms examples

6.3 Earth Potential [U]

AC Voltage	Measurement	Test Mode	Test Method	Limit
U	U touch	single	4-wire	yes

Table 6.13: Available Earth Potential measurements with the MI 3144

Note (acc.to IEEE Std 81):

- Touch voltage - general definition. The potential difference between the GPR of a grounding grid or system and the surface potential where a person could be standing while at the same time having a hand in contact with a grounded structure or object.

6.3.1 U touch Measurement



Proposed measurement can be referenced to standard IEEE-81 par. 9.

The measurement is performed between an earthed accessible metal part and ground as shown on Figure 6.14. The voltage between the probes is measured by a voltmeter with an external resistance of 1 kΩ (adapter A 1597) that simulates the body resistance.

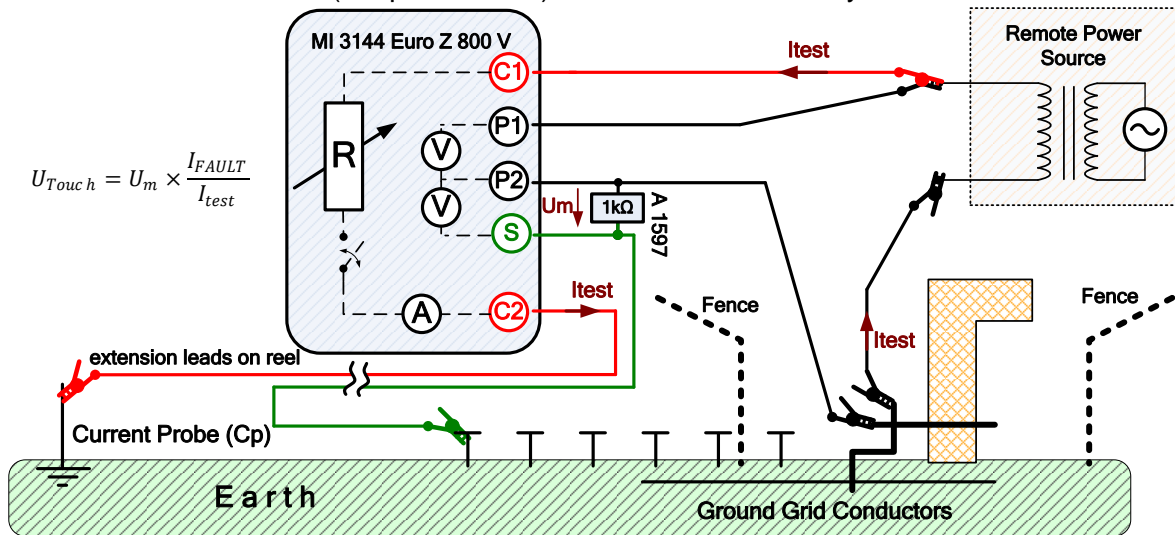

Figure 6.14: U touch Measurement example

During the measurement, an internal resistance is connected between C1 and C2 for a period of a half cycle. The resistance of the current probe should be as low as possible in order to inject a high test current. The resistance can be decreased by using more probes in parallel or using an auxiliary earthing system as the auxiliary probe. A higher injected current improves the immunity against spurious earth currents. The instrument internal shunt resistor measures the current (I_{test}). A voltmeter measures the voltage drop across a 1 kΩ resistor (A 1597). The (U_{Touch}) voltage is determined from the fault current / measured current ratio multiplied with the measured voltage. In the example, following U_{Touch} voltage is measured:

$$U_{Touch} = U_m \times \frac{I_{FAULT}}{I_{test}}$$

where:

- U_{Touch} Calculated Touch voltage in case of a fault current
- I_{FAULT} Set fault current (maximal earth current in case of a fault)
- U_m Measured voltage drop
- I_{test} Test current

6.4 ELR Test [I and t]

The MI 3144 Euro Z 800 V instrument is supporting testing of ELR-s or Modular Residual Current Devices (MRCD) without integral current breaking devices and with separate sensing means.

MRCDD Test	Measurement	Test Mode	ELR Type	Limit	Filter
I, t	ELR Current Injection Test	single	AC, A, B	yes	AC/DC
	ELR Combination Time Test	single	AC, A, B	yes	AC/DC

Table 6.15: Available ELR measurements in the MI 3144

Note (acc.to IEC 60947-2 Annex M):

- The ELR (MRCD) shall be installed, mounted and wired according to the manufacturer's instructions. Unless otherwise specified, it is connected to a test equipment, as specified by the manufacturer, representing normal service conditions for the output circuit in order to verify the change in the status of the output. For the measurement of the combination time, the ELR is connected to a circuit-breaker, specified by the manufacturer, and installed on the monitored circuit.

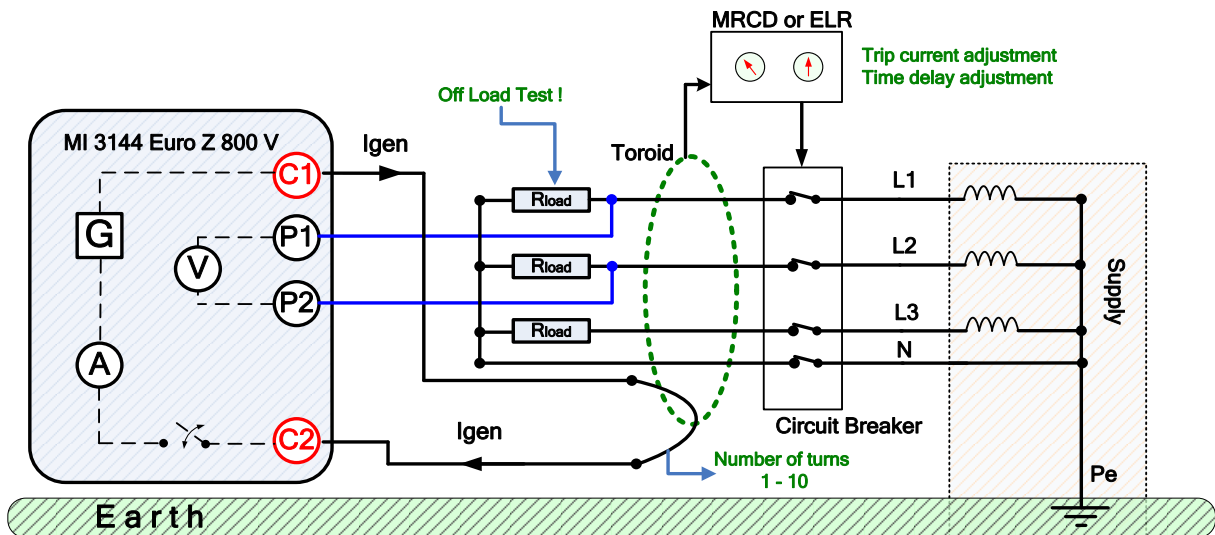

Figure 6.16: ELR Current Injection Test and Combination Time Test example

I_{gen} , Test duration, Number of turns and Current waveform shape relations:

I _{gen}	Test duration (s)	Number of turns	Current Waveform shape		
			Alternating	Pulsed	DC
3 mA	0.3 0.5 1 2 5 10 20	1 2 3 4 5 6 7 8 9 10	AC	A	B
5 mA			AC	A	B
6 mA			AC	A	B
10 mA			AC	A	B
15 mA			AC	A	B
30 mA			AC	A	B
50 mA			AC	A	B
100 mA			AC	A	B
150 mA			AC	A	●
250 mA			AC	A	●
300 mA			AC	A	●
500 mA			AC	A	●

Table 6.17: Available generation currents in the MI 3144

6.4.1 ELR Current Injection Test



Verification of operation in case of a steady increase of the residual current.

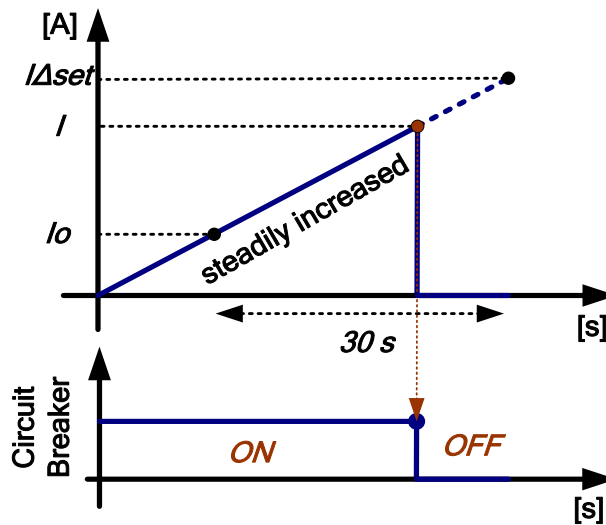

Figure 6.18: ELR Current Injection Test waveforms example

During the measurement the circuit breaker is in the closed position (ON), and the ELR (MRCD) being ready to operate, the residual current is **steadily increased**, starting from a value not higher than 10 % of I_{Δset}, up to I_{Δset} value in approximately 30 s. The current value causing tripout of the ELR (MRCD) - change to (OFF) state in the status of the circuit breaker is displayed as I.

I_{Δset} is calculated as follows:

$$I_{\Delta set} = I_{gen} \times (\text{number of turns})$$

where:

I..... Current value, which causes the ELR (MRCD) to operate.

I_{Δset}..... Set current value or end value (I_{gen} multiplied by number of turns).

I₀..... starting current (10 % of I_{Δset}).

Always count the inner number of turns!

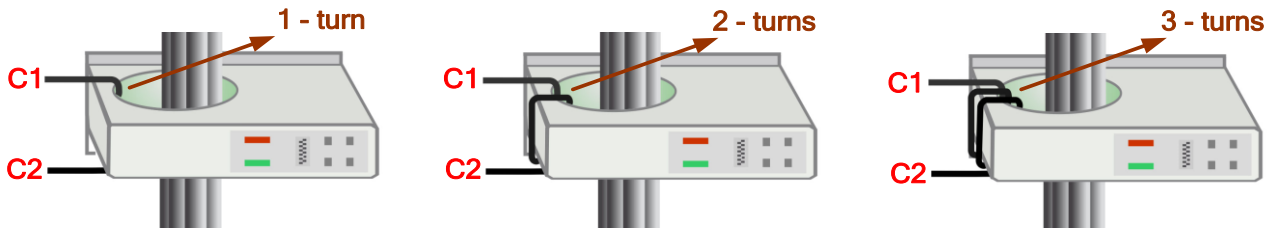

Figure 6.19: Number of turns - example

6.4.2 ELR Combination Time Test



Verification of the correct operation in case of a suddenly appearing residual current.

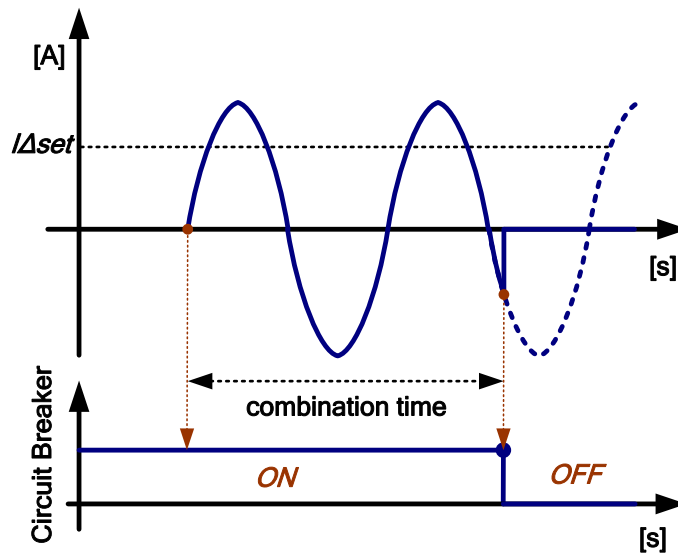

Figure 6.20: ELR Combination Time Test current waveforms example

During the measurement the circuit breaker is in the closed position (ON), and the ELR (MRCD) being ready to operate, the residual current is **suddenly established** (set value). The instrument is measuring the combination time (ELR + Circuit Breaker) from establishing the current ($I_{\Delta set}$) to the change detected in the circuit breaker OFF state.

where:

t Total operating time or combination time.

$I_{\Delta set}$ Set current value (I_{gen} multiplied by number of turns).

6.5 Current [I]

Current	Measurement	Test Mode	Nominal frequency	Filter	Type	Max. Measuring range
I	Current Clamp Meter	cont.	16 Hz – 420 Hz	RMS	A1227	3000 A
					A1281	1000 A
					A1609	3000 A

Table 6.21: Available Current measurements in the MI 3144

6.5.1 Current Clamp Measurement



A1281 AC current clamp

The A 1281 multi range current clamps are designed for measuring alternating currents on low and medium power installations: (50 mA ... 1000 A). Clamps have four current ranges 0.5 A, 5 A, 100 A and 1000 A, which are selected directly on master instrument. Embedded electronic module is powered directly from the connected Euro Z instrument and does not need any additional power supply.

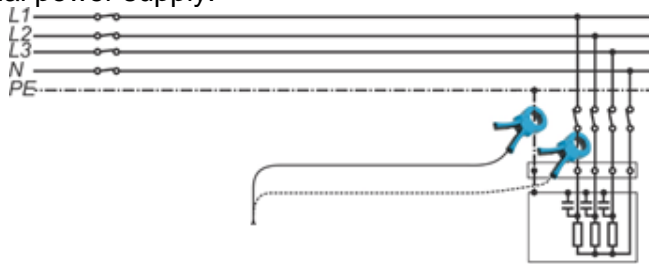
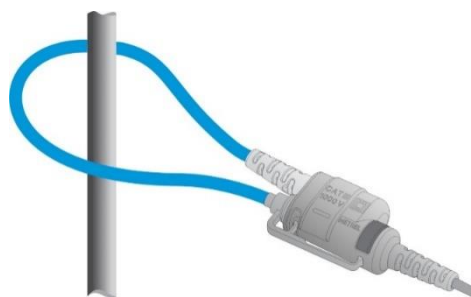

Figure 6.22: A1281 Clamp example

A1227 and A1609 Flex current clamp

1. Wrap the flexible measuring head around the conductor to be tested and close coupling.



- It is very important that the conductor is in the centre and perpendicular to the current sensor as much as possible, in order to minimise position measurement error.
 - Minimise influence of adjacent current-carrying conductors, and measure at the point where they are far away from each other.
 - Make sure that the arrow marked on the clamp coupling points toward the correct orientation for correct phase.
 - Keep the clamps coupling more than 2.5 cm (1 in) away from conductor.
2. Connect Flexible Current Clamps to the clamp input on the Euro Z instrument.
 3. Select appropriate Current clamp range.
 4. Start measurement.
 5. Observe the current value on the master instrument's display. If desired, select the lower clamp range for better accuracy.

7 Communication

There are two communication interfaces available on the Euro Z instrument for communication with master instrument or Android device: RS-232 and Bluetooth.

RS-232 communication

Serial interface cable is required. See following figures for correct connection.

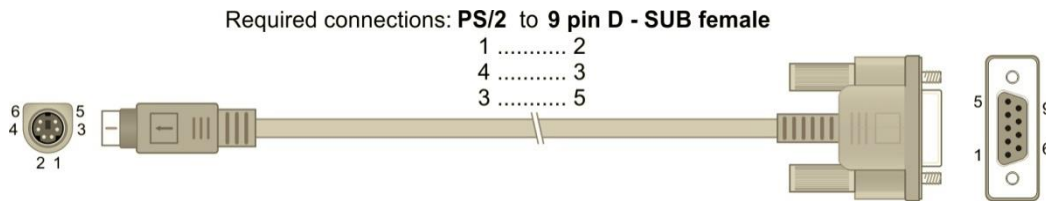

Figure 7.1: RS-232 connection – (Example of connection with MI 3152 or MI 3155)

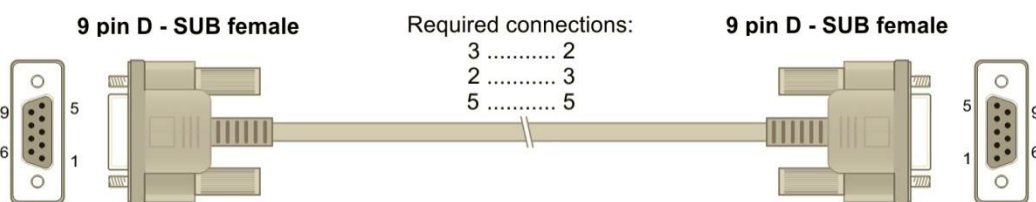

Figure 7.2: RS-232 connection (Example of connection to master instrument with standard 9-pin D-SUB type serial port)

Bluetooth communication

The internal Bluetooth module enables easy communication via Bluetooth with PC and Android devices.

How to configure a Bluetooth link between Euro Z instrument and Android device

- › Switch On the Euro Z instrument.
- › Some Android applications automatically carry out the setup of a Bluetooth connection. It is preferred to use this option if it exists. This option is supported by Metrel's Android applications.
- › If this option is not supported by the selected Android application then configure a Bluetooth link via Android device's Bluetooth configuration tool. Usually no code for pairing the devices is needed.
- › The instrument and Android device are ready to communicate.

Notes

- ❑ Sometimes there will be a demand from the PC or Android device to enter the code. Enter code **'1234'** to configure the Bluetooth link correctly.
- ❑ The name of correctly configured Bluetooth device must consist of the instrument type plus serial number, e.g. MI 3144-123456781. If the Bluetooth module got another name, the configuration must be repeated.

8 Maintenance

Unauthorized persons are not allowed to open the Euro Z instrument. There are no user replaceable components inside the instrument. Batteries can only be replaced with certified ones and only by authorized persons.

8.1 Cleaning

No special maintenance is required for the housing. To clean the surface of the instrument, use a soft cloth slightly moistened with soapy water or alcohol. Then leave the instrument to dry totally before use.

Warnings:

- ❑ Do not use liquids based on petrol or hydrocarbons!
- ❑ Do not spill cleaning liquid over the instrument!

8.2 Periodic calibration

It is essential that the test instrument is regularly calibrated in order that the technical specification listed in this manual is guaranteed. We recommend an annual calibration. Only an authorized technical person can do the calibration. Please contact your dealer for further information.

8.3 Service

For repairs under warranty, or at any other time, please contact your distributor.

8.4 Upgrading the instrument

The Euro Z instrument can be upgraded from a PC via the RS232 communication port. This enables to keep the Euro Z instrument up to date even if the standards or regulations change. Download the latest firmware on the Metrel download centre:

<https://www.metrel.si/en/downloads/>

Special upgrading software - **FlashMe** will guide you through the upgrading procedure. For correct connection, see *Figure 8.1*. Contact your dealer for more information.

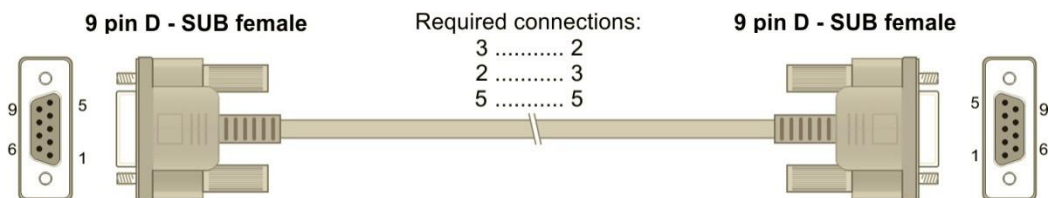

Figure 8.1: RS-232 Interface connection required for upgrading the Euro Z instrument

9 Technical specifications

9.1 Impedance [Z]

9.1.1 Z line mΩ, Z loop mΩ

Measuring range according to EN 61557-3: 12.0 mΩ ... 19.99 Ω

Measurement principle Voltage / Current measurement (synchronous sampling)

Line Impedance Loop Impedance	Measuring range (Ω)	Resolution (mΩ)	Uncertainty (* See notes)
Z	0.1 m ... 199.9 m	0.1	±(5 % of reading + 3 mΩ)
	200 m ... 1999 m	1	
	2.00 ... 19.99	10	±(5 % of reading + 3 digits)

- Test mode single
- Measuring voltage range 40 V ... 470 V @ (16 Hz ... 420 Hz)
40 V ... 800 V @ (40 Hz ... 420 Hz)
- Measuring frequency range 16 Hz ... 420 Hz
- Maximum test current see chapter **9.7 Test Current, Figure 9.3**
- Test method 4-wire
- R and XL values yes
- Averaging option off, 2, 4, 6
- Automatic range selection yes
- Automatic test of voltage noise yes

Displayed Prospective Short Circuit Current (I_{psc}) is calculated as follows:

$$I_{psc} = \frac{U_n \times k_{sc}}{Z}$$

If the Nominal Voltage (U_n) is in the tolerance of ±6 % or ±10 % (parameter setting!) than the prospective short current (I_{psc}) will be calculated. Exceeding the nominal voltage tolerance by ±6 % or ±10 % then I_{psc} will not be calculated and the horizontal dashes (- - -) will be displayed.



where:

- Z measured Impedance
- U_n nominal voltage
- k_{sc} Correction factor (I_{sc} factor) for I_{psc}
- Tolerance Nominal voltage system tolerance (±6 % or ±10 %)

Refer to **Appendix C– Short-circuit currents in 3p a.c. systems** for more information.

* Notes:

- System voltage and frequency kept constant during measurement!
- When measuring at low current amplitudes (test load parameter set to 16.6 % and 33.3 %) the result can vary!
- If the measurement triggers a fuse (the voltage drops to zero), the measurement will abort (stop).



Measurement is aborted. Consider displayed warnings and messages.

9.1.2 High Current

Measurement principle Voltage / Current (external Clamp option) measurement

Resistance	Measuring range (Ω)	Resolution (mΩ)	Uncertainty (* See notes)
ΔR	0.1 m ... 199.9 m	0.1	±(5 % of reading + 3 mΩ)
	200 m ... 1999 m	1	
	2.00 ... 19.99	10	±(5 % of reading + 3 digits)

Selective Resistance	Measuring range (Ω)	Resolution (mΩ)	Uncertainty (* See notes)
Rsel	0.1 m ... 199.9 m	0.1	±(8 % of reading + 3 mΩ)
	200 m ... 1999 m	1	
	2.00 ... 19.99	10	±(8 % of reading + 3 digits)

Test mode single

Measuring voltage range 40 V ... 470 V @ (16 Hz ... 420 Hz)

40 V ... 800 V @ (40 Hz ... 420 Hz)

Measuring frequency range 16 Hz ... 420 Hz

Maximum test current see chapter **9.7 Test Current, Figure 9.3**

Test method 4-wire

Averaging option off, 2, 4, 6

Automatic range selection yes

Automatic test of voltage noise yes



* Notes:

- System voltage and frequency kept constant during measurement!
- When measuring at low current amplitudes (test load parameter set to 16.6 % and 33.3 %) the result can vary!
- Minor exceeding the clamp range will cause the instrument to display > and the appropriate range (e.g. >599 A).
- Large exceeding of the clamp range or wrong clamps selected will cause the horizontal dashes (- - -) to be displayed.
- Uncertainty of R_{sel} depends on the correct or optimum selection of the clamp range!
- If the measurement triggers a fuse (the voltage drops to zero), the measurement will abort (stop).

	Low test current through Iron or Flex clamps. Results may be impaired. Limit [I_c (test current) < 10 % of range].
--	---

9.1.3 Averaging options

Additional averaging is built within the instrument to reduce the influence of noise on measurement results. This option enables more stable results especially when dealing with low impedance measurement in noisy environment with interharmonics and power-line flickers.

Measurement function **Z line mΩ, Z loop mΩ, High Current**

In the measurement function, the status of the averaging option is shown in the measurement control window. The table below contains a definition of the individual averaging options and measuring times:

Averaging options	Meaning	Typical measuring times (s)		
		@ 230 V, 50 Hz	@ 415 V, 50 Hz	@ 690 V, 50 Hz
Off (1)	Averaging is disabled	3	3	3
2	Average of 2 results	4	5	7
4	Average of 4 results	7	10	15
6	Average of 6 results	10	15	25

9.2 DC Source & Line Resistance [R]

9.2.1 R line mΩ

Measurement principle: Voltage (dc) / Current (dc) measurement

Resistance	Measuring range (Ω)	Resolution (mΩ)	Uncertainty (* See notes)
R	0 m ... 1999 m	1	±(5 % of reading + 3 digits)
	2.00 ... 19.99	10	

Test mode single
 Nominal voltage ranges 3 ... 260 V_{dc}
 Test current see **Figure 9.1**
 Max test current (I_{test}) ~10 A
 Test current duration 20 ms
 R definition Resistance value R(dc)
 Test method 4-wire
 Measuring time typical 2 s
 Automatic range selection yes
 Automatic test of voltage noise yes

Test Current (I_{test}) is automatically set as follows and is dependent of the internal resistance (R_{int}) of the measured object:

$$I_{test} \approx \frac{200\text{ W}}{U_{dc}} \quad \text{and} \quad I_{test} < \frac{U_{dc}}{R_{int}}$$

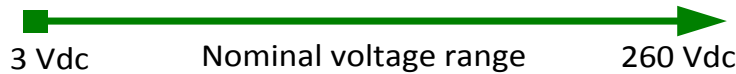

* Notes:

- System voltage kept constant during measurement!
- Battery must be fully charged to measure the internal resistance.

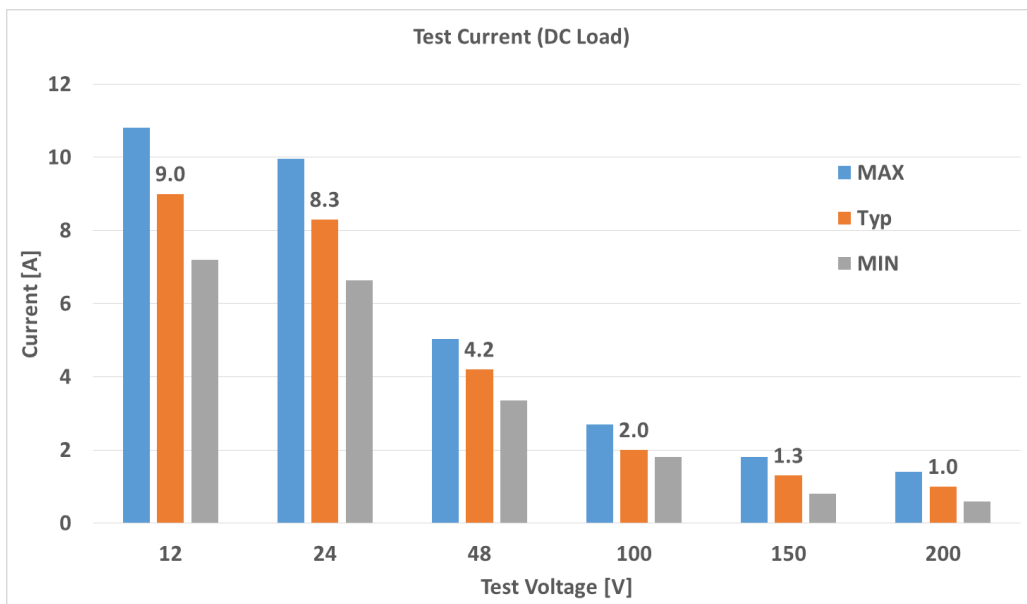

Figure 9.1: Relation between test current (DC load) and nominal voltage

9.3 Earth Potential [U]

9.3.1 U touch

Measurement principle Current / Voltage measurement

Voltage	Measuring range (V)	Resolution (V)	Uncertainty (* See notes)
U_{touch}	0.0 ... 199.9	0.1	calculated value
	200 ... 999	1	

Test mode single

Measuring voltage range 40 V ... 470 V @ (16 Hz ... 420 Hz)
40 V ... 800 V @ (40 Hz ... 420 Hz)

Measuring frequency range 16 Hz ... 420 Hz

Maximum test current see chapter **9.7 Test Current, Figure 9.3**

Measuring time typical 2 s

Input resistance (P1 – P2) 6 MΩ

Input resistance (P2 – S) 6 MΩ

Ifault range (selectable) Custom, 10 A ... 200 kA

Displayed Touch Voltage (U_{Touch}) is calculated as follows:

$$U_{Touch} = U_m \times \left(\frac{I_{fault}}{I_{test}} \right)$$

Sub-result in measurement function U_{Touch} :

Voltage	Measuring range (V)	Resolution (V)	Uncertainty (* See notes)
U_m	1 m ... 1999 m	1 m	±(2 % of reading + 2 digits)
	2.00 ... 19.99	10 m	
	20.0 ... 199.9	0.1	

*Notes:

- A 1597 Human body probe with an internal resistance of 1 kΩ ±1 %, 10 W.
- System voltage and frequency kept constant during measurement!
- When selecting high I_{fault} parameters > 50 kA. Measuring at low current amplitudes (test load parameter set to 16.6 % and 33.3 %) the result can vary!

9.4 Sub-results in measurement functions

Sub-result	Measuring range	Resolution	Uncertainty
R, XL	0 mΩ ... 19.9 Ω	1 mΩ ... 0.1 Ω	Indication only
I_psc	0.01 A ... 199 kA	0.01 A ... 1 kA	calculated value
I_{max}, I_{min}, I_{max2p}, I_{min2p}, I_{max3p}, I_{min3p}	0.01 A ... 199 kA	0.01 A ... 1 kA	calculated value
I_{test}	0.1 A ... 499 A	0.1 A ... 1 A	±(2 % of reading + 3 digits)
U	0 V ... 999 V	1 V	±(2 % of reading + 3 digits)
I_c	0.1 A ... 499 A	0.1 A ... 1 A	±(5 % of reading + 3 digits)
U_{dc}	0.1 V ... 220 V	0.1 V ... 1 V	±(2 % of reading + 3 digits)
ΔU	1 mV ... 199.9 V	1 mV ... 0.1 V	±(2 % of reading + 3 digits)
ΔU%	0.0 % ... 100.0 %	0.1 %	calculated value
f	0.1 Hz ... 499 Hz	0.1 Hz ... 1 Hz	±(0.2 % of reading + 1 digit)

9.5 ELR Test [I and t]

9.5.1 ELR Current Injection Test and ELR Combination Time Test

Measurement principle: Current and time measurement

Residual operating current	Measuring range (A)	Resolution (mA)	Uncertainty (* See notes)
I	0.1 m ... 199.9 m	0.1	±(5 % of reading + 3 digits)
	200 m ... 1999 m	1	
	2.00 ... 19.99	10	

Measurement principle: Voltage and time measurement

Combination time	Measuring range (s)	Resolution (ms)	Uncertainty
t	0.1 m ... 199.9 m	0.1	±(2 % of reading + 3 digits)
	200 m ... 1999 m	1	
	2.00 ... 20.00	10	

Test mode single

Current Waveform Alternating, Pulsating, DC

Test current 3 mA, 5 mA, 6 mA, 10 mA, 15 mA, 30 mA, 50 mA, 0.1 A, 0.15 A, 0.25 A, 0.3 A, 0.5 A

Test duration time 0.3 s, 0.5 s, 1 s, 2 s, 5 s, 10 s, 20 s

Phase (+), (-)

Number of turns 1 ... 10

Output current accuracy ±10 %

Max output load resistance (C1 - C2) 1 Ω

Measuring voltage range (P1 - P2) 40 V ... 800 V

Measuring frequency range (P1 - P2) 16 Hz ... 420 Hz

Displayed Test Current ($I_{\Delta set}$) is calculated as follows:

$$I_{\Delta set} = I_{gen} \times (\text{number of turns})$$

(Example: $I_{\Delta set} = 0.5 \text{ A} \times 10 = 5 \text{ A}$)

Notes:

- False Triggering can occur because of the high sensitivity of the internal voltmeter (P1-P2). Voltage dip can trigger an ELR, MRCD test.
- Improper connection will trigger a measurement abort (C1 - C2 terminal open).

	Measurement is aborted. Consider displayed warnings and messages.
---	---

- System voltage and frequency kept constant during measurement!
- Make sure that the number of turns is correctly entered in the test parameters window!

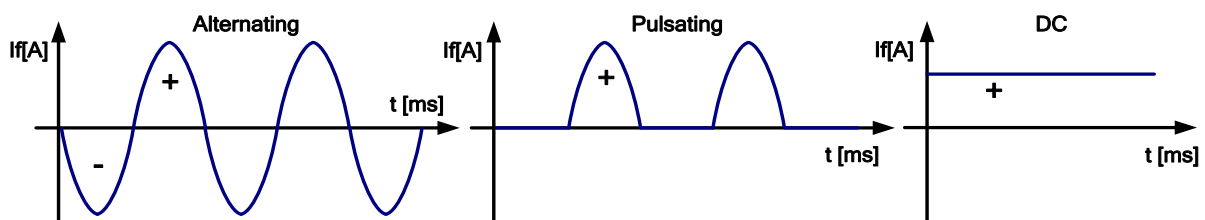

Figure 9.2: Current waveform shape

9.6 Current [I]

9.6.1 Iron (A 1281) and Flex (A 1227, A 1609) current clamp

Measurement principle: Current measurement (RMS)

Current	Type	Range (A)	Measuring range (A)	Display range (A)	Resolution (A)	Overall Uncertainty (* See notes)
I	A 1281	0.5	10 m ... 749 m	0 m ... 749 m	1 m	±(2.5 % of reading + 3 digits)
		5	0.10 ... 7.49	0.00 ... 7.49	0.01	
		100	2 ... 149	0.0 ... 99.9 A	0.1	
				100 ... 149	1	
	1000	20 ... 999	0 ... 999	1		
	A 1227 A 1609	30	0.6 ... 59.9	0.0 ... 59.9	0.1	±(3.5 % of reading + 3 digits)
		300	6 ... 599	0 ... 599	1 A	
3000		0.06 k ... 5.99 k	0.00 k ... 5.99 k	0.01 k		

Input terminal galvanic separated (clamp connector)

Test mode continuous

Measuring frequency range 16 Hz ... 420 Hz

Input impedance 100 kΩ (clamp connector)

Instrument accuracy (clamp connector) 2 %

Measuring refresh rate 3 s typical

***Notes:**

- Minor exceeding the clamp range will cause the instrument to display > and the appropriate range (e.g. >599 A).
- Large exceeding of the clamp range or wrong clamps selected will cause the horizontal dashes (- - -) to be displayed.
- Frequency is only displayed if ($I_m \geq 1 \% I_{clamp_range}$), where I_m presents measured current and I_{clamp_range} set value of clamp range. Otherwise the horizontal dashes (- - -) are displayed.
- Overall uncertainty (as percent of measured value), is provided as guideline. For exact measuring range and uncertainty, please check user manual of related current clamps. Overall uncertainty is calculated as:

$$OverallAccuracy = 1,15 \cdot \sqrt{InstrumentAccuracy^2 + ClampAccuracy^2}$$

9.7 Test Current

Measurement function Z line mΩ, Z loop mΩ, High Current, U touch

Test Current (I_{test}) is set as follows:

$$I_{test} = \frac{U_{ac}}{Test_load + R_{leads} + R_{int}} \pm 15 \%$$

Test voltage (U_{ac})..... 40 V ... 800 Vac

Test load parameter..... 16.6 %, 33.3 %, 50 %, 66.6 %, 83.3 %, 100 %

Test current duration..... depends on the system frequency

R_leads..... C1 and C2 test leads resistance

R_int..... internal resistance or impedance of the power source

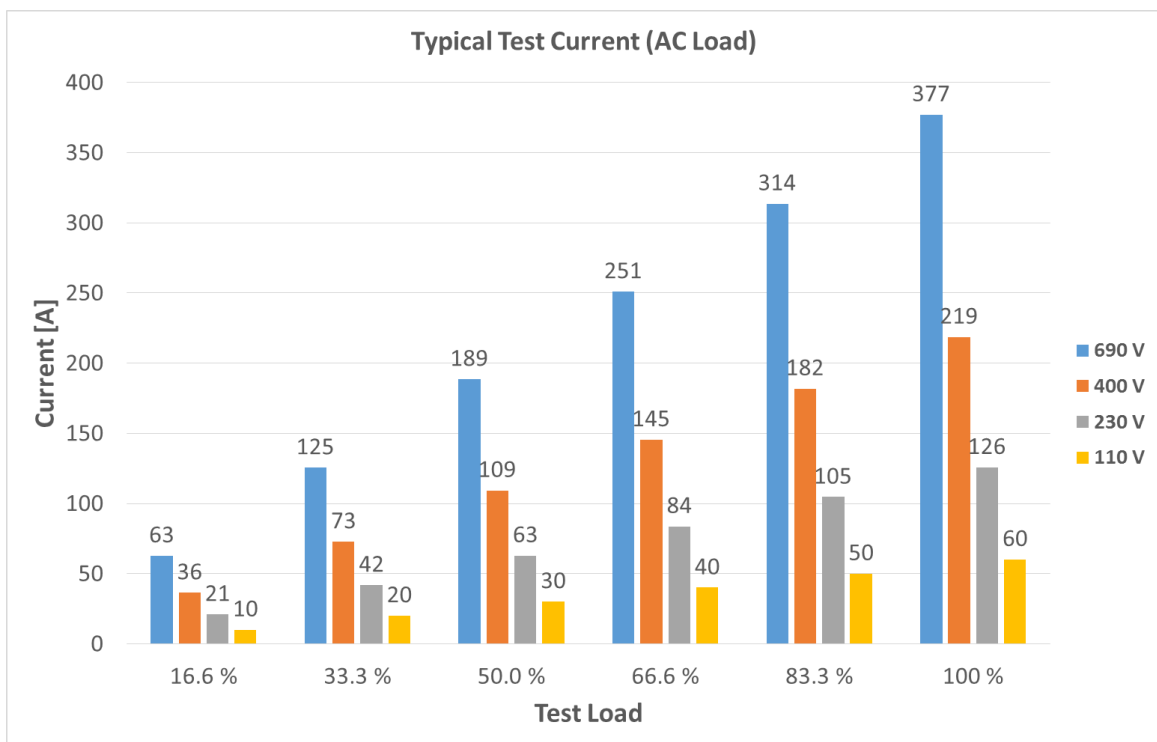

Figure 9.3: Typical test currents (AC Load) in relation to nominal voltage and test load

Internal variable load power resistor with 6-stage value setup.

Test load parameter	Equivalent load resistance
16.6 %	11.0 Ω
33.3 %	5.50 Ω
50.0 %	3.66 Ω
66.6 %	2.75 Ω
83.3 %	2.20 Ω
100 %	1.83 Ω

Note:

- Test leads resistance for standard supplied leads C1 + C2 is typ. 60 mΩ (red leads 2.5 m, 1.5 mm²).

9.8 General data

Battery power supply.....	7.2 V _{DC} (4.4 Ah Li-ion)
Battery charging time	typical 3.0 h (deep discharge)
Mains power supply.....	90 V ... 260 V _{AC} , 45 Hz ... 65 Hz, 80 VA
Over-voltage category	300 V CAT II

Battery operation time:

Idle state	> 24 h
Measurements.....	> 12 h continuous testing for line, loop, high current
Auto-off timer	10 min (idle state)

Protection classification.....	reinforced insulation 
Measuring category	600 V CAT IV

Pollution degree.....	2
Degree of protection.....	IP 65 (case closed), IP 54 (case open)

Dimensions (w × h × d)	36 cm x 16 cm x 33 cm
Weight	7 kg, (without accessories)

Visual warnings

Reference conditions:

Reference temperature range	25 °C ± 5 °C
Reference humidity range	40 %RH ... 60 %RH

Operation conditions:

Working temperature range	-10 °C ... 50 °C
Maximum relative humidity.....	90 %RH (0 °C ... 40 °C), non-condensing
Working nominal altitude	up to 3000 m

Storage conditions:

Temperature range.....	-10 °C ... 70 °C
Maximum relative humidity.....	90 %RH (-10 °C ... 40 °C)
.....	80 %RH (40 °C ... 60 °C)

RS 232 communication:

RS 232 serial communication.....	galvanic separated
Baud rate:.....	115200 baud rate, 1 stop bit, no parity
Connector:	standard RS232 9-pin D male

Bluetooth communication:













Device pairing code:.....	1234
Baud rate:.....	115200 bit/s
Bluetooth module	class 2

Specifications are quoted at a coverage factor of $k = 2$, equivalent to a confidence level of approximately 95 %. Accuracies apply for 1 year in reference conditions. Temperature coefficient outside these limits is 0.2 % of measured value per °C, and 1 digit.

Appendix A – Supported Instruments Selection Table

Supported instruments and devices are:

- MI 3155 EurotestXD;
- MI 3152 EurotestXC;
- MI 3325 MultiServicerXD;
- aMESM (Android App).

Measurement functions available		MI 3155	MI 3152	MI 3325	aMESM	
MI 3144 Euro Z 800 V		EurotestXD	EurotestXC	MultiServicerXD		
	Icon	Group				
Z line mΩ		Impedance	•	•	•	•
Z loop mΩ		Impedance	•	•	•	•
High Current		Impedance	•	•	•	•
R line mΩ		Resistance	•	•	•	•
U touch		Potential	•	•	•	•
Current Injection Test		ELR	•	•	•	•
Combination Time Test		ELR	•	•	•	•
Current Clamp Meter		Current	•	•	•	•

Appendix B – MRCD Test (acc.to IEC 60947-2 Annex M)

I. Current Injection Test

AC Type ELR (MRCD) test procedure

During the measurement the circuit breaker is in the closed position (ON), and the ELR (MRCD) being ready to operate, the residual current is **steadily increased**, starting from a value not higher than $0.2 \times I_{\Delta n}$, up to $I_{\Delta n}$ (set value) in approximately 30 s. The current value causing change (OFF) in the status of the circuit breaker is displayed as $I_{\Delta n}$.

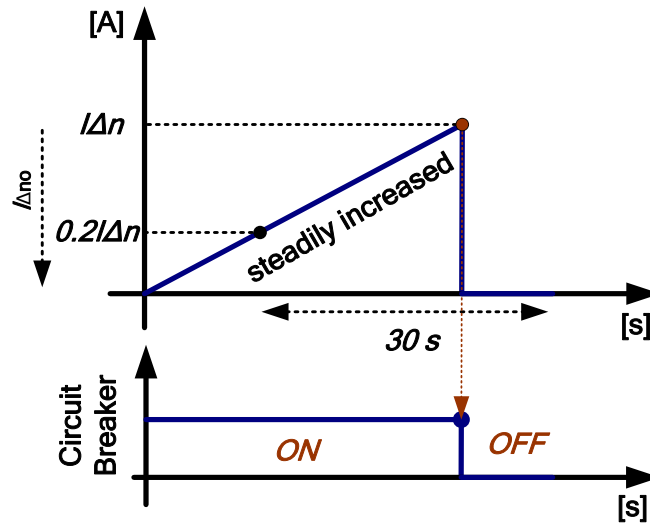

Figure B.1: Current Injection Test waveforms example (AC Type)

where:

- $I_{\Delta n}$ Residual operating current
- $I_{\Delta no}$ Non-operating residual current

Note (acc.to IEC 60947-2 Annex M):

- $I_{\Delta n}$ - Residual operating current (value of the residual current, which causes the ELR (MRCD) to operate under specified conditions)
- $I_{\Delta no}$ - Non-operating residual current (value of the residual current at which the ELR (MRCD) does not operate under specified conditions)

A Type ELR (MRCD) test procedure

During the measurement the circuit breaker is in the closed position (ON), and the ELR (MRCD) being ready to operate, the residual current is **steadily increased**, starting from zero, up to $1.4 \times I_{\Delta n}$ or $2 \times I_{\Delta n}$ (depending on the set value) in approximately 30 s. The current value causing change (OFF) in the status of the circuit breaker is displayed as $I_{\Delta n}$.

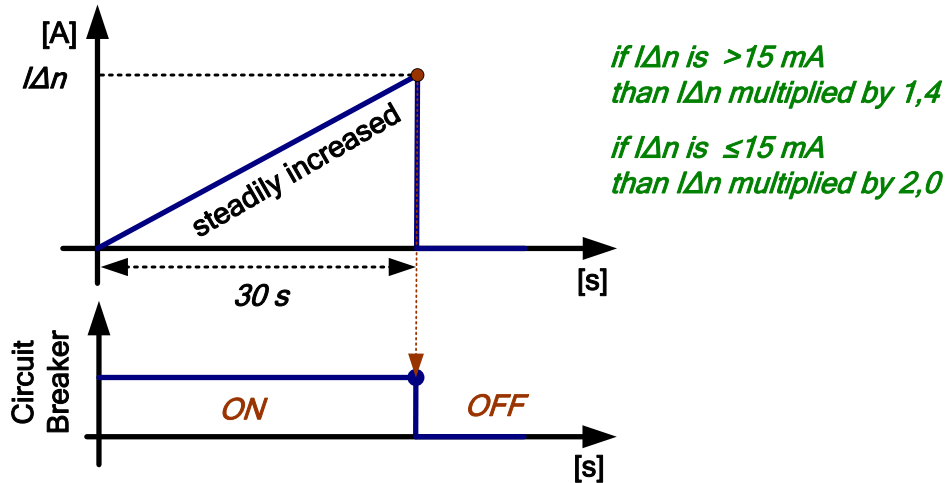

Figure B.2: Current Injection Test waveforms example (A Type)

B Type ELR (MRCD) test procedure

During the measurement the circuit breaker is in the closed position (ON), and the ELR (MRCD) being ready to operate, the residual current is **steadily increased**, starting from zero, up to $2 \times I_{\Delta n}$ (set value) in approximately 30 s. The current value causing change (OFF) in the status of the circuit breaker is displayed as $I_{\Delta n}$.

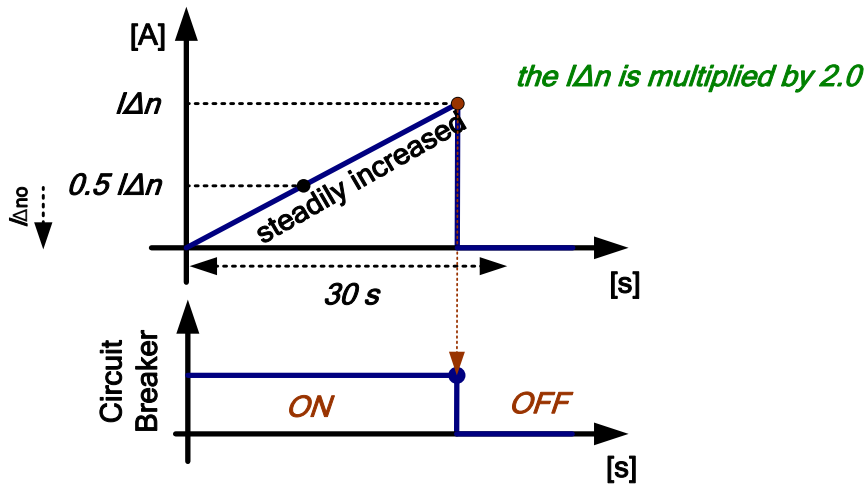

Figure B.3: Current Injection Test waveforms example (B Type)

II. Combination Time Test

AC Type ELR (MRCD) test procedure

During the measurement the circuit breaker is in the closed position (ON), and the ELR (MRCD) being ready to operate, the residual current is **suddenly established** (set value $I_{\Delta n}$).

The instrument is measuring the combination time (ELR + Circuit Breaker) from establishing the current ($I_{\Delta n}$) to the change detected in the circuit breaker OFF state.

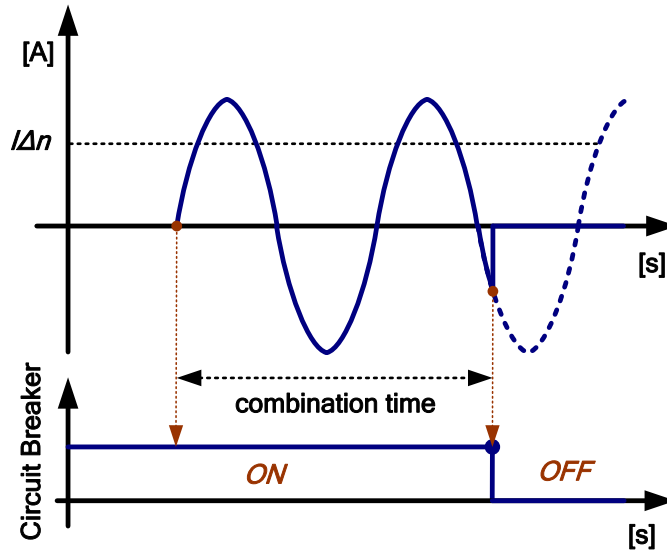

Figure B.4: Combination Time Test current waveforms example (AC Type)

where:

$t_{\Delta n}$ Total operating time or combination time

$I_{\Delta n}$ Residual operating current

Note (acc.to IEC 60947-2 Annex M):

- Total operating time of an MRCD and associated circuit breaker (**combination time**) - Time, which elapses between the instant when the residual operating current is suddenly applied and the instant of the arc extinction of the associated circuit breaker.

A Type ELR (MRCD) test procedure

During the measurement the circuit breaker is in the closed position (ON), and the ELR (MRCD) being ready to operate, the residual current is **suddenly established** ($1.4 \times I_{\Delta n}$ or $2 \times I_{\Delta n}$ - depending on the set value).

The instrument is measuring the combination time (ELR + Circuit Breaker) from establishing the current ($I_{\Delta n}$) to the change detected in the circuit breaker OFF state.

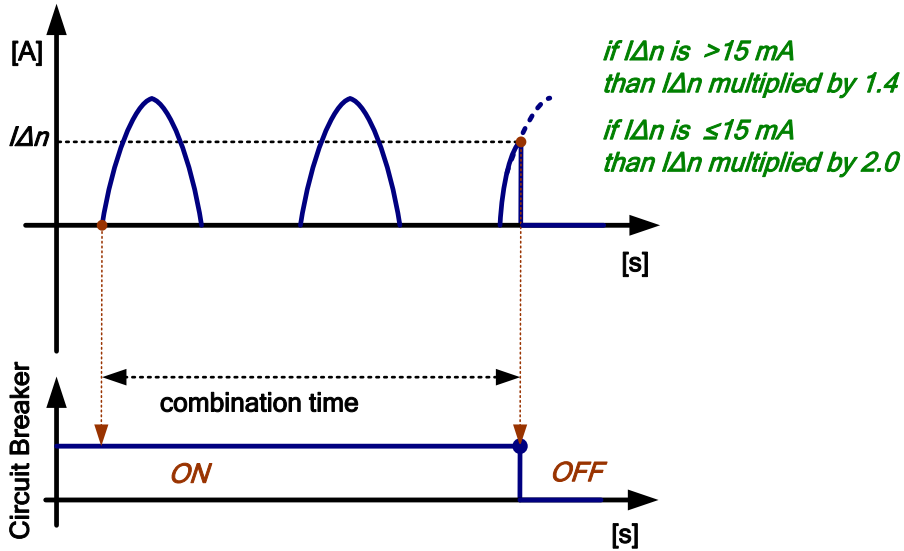

Figure B.5: Combination Time Test current waveforms example (A Type)

B Type ELR (MRCD) test procedure

During the measurement the circuit breaker is in the closed position (ON), and the ELR (MRCD) being ready to operate, the residual current is **suddenly established** (set value $2 \times I_{\Delta n}$).

The instrument is measuring the combination time (ELR + Circuit Breaker) from establishing the current ($I_{\Delta n}$) to the change detected in the circuit breaker OFF state.

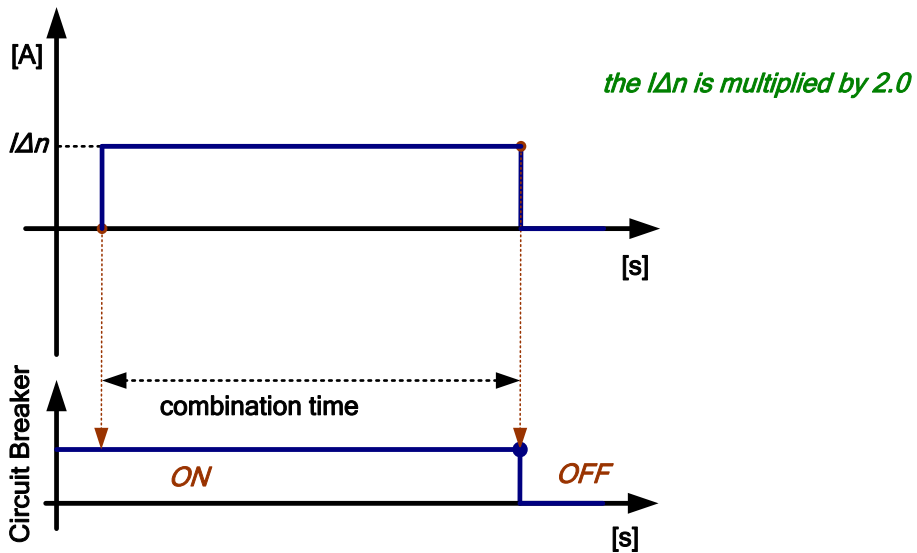

Figure B.6: Combination Time Test current waveforms example (B Type)

Appendix C – Short-circuit currents in 3p a.c. systems

Voltage factor c according to the EN 60909 – 0

Nominal system voltage U_n		Voltage factor c	
	voltage system with a tolerance (Tolerance)	Maximum short-circuit currents C_{max}	Minimum short-circuit currents C_{min}
100 V to 1000 V	$\pm 6 \%$	1.05	0.95
	$\pm 10 \%$	1.10	0.90

Z loop m Ω Measurement

The prospective fault currents I_{Min} and I_{Max} are calculated as follows:

$I_{Min} = \frac{C_{min} U_{N(L-PE)}}{Z_{(L-PE)hot}}$	where	$Z_{(L-PE)hot} = \sqrt{(1.5 \times R_{L-PE})^2 + X_{L-PE}^2}$ $C_{min} = \begin{cases} 0.95; U_{N(L-PE)} \pm 6 \% \\ 0.90; U_{N(L-PE)} \pm 10 \% \end{cases}$
$I_{Max} = \frac{C_{max} U_{N(L-PE)}}{Z_{L-PE}}$	where	$Z_{L-PE} = \sqrt{R_{L-PE}^2 + X_{L-PE}^2}$ $C_{max} = \begin{cases} 1.05; U_{N(L-PE)} \pm 6 \% \\ 1.10; U_{N(L-PE)} \pm 10 \% \end{cases}$

Z line m Ω Measurement

The prospective short-circuit currents I_{Min} , I_{Min2p} , I_{Min3p} and I_{Max} , I_{Max2p} , I_{Max3p} are calculated as follows:

$I_{Min} = \frac{C_{min} \times U_{N(L-N)}}{Z_{(L-N)hot}}$	where	$Z_{(L-N)hot} = \sqrt{(1.5 \times R_{(L-N)})^2 + X_{(L-N)}^2}$ $C_{min} = \begin{cases} 0.95; U_{N(L-N)} \pm 6 \% \\ 0.90; U_{N(L-N)} \pm 10 \% \end{cases}$
$I_{Max} = \frac{C_{max} \times U_{N(L-N)}}{Z_{(L-N)}}$	where	$Z_{(L-N)} = \sqrt{R_{(L-N)}^2 + X_{(L-N)}^2}$ $C_{max} = \begin{cases} 1.05; U_{N(L-N)} \pm 6 \% \\ 1.10; U_{N(L-N)} \pm 10 \% \end{cases}$
$I_{Min2p} = \frac{C_{min} \times U_{N(L-L)}}{Z_{(L-L)hot}}$	where	$Z_{(L-L)hot} = \sqrt{(1.5 \times R_{(L-L)})^2 + X_{(L-L)}^2}$ $C_{min} = \begin{cases} 0.95; U_{N(L-L)} \pm 6 \% \\ 0.90; U_{N(L-L)} \pm 10 \% \end{cases}$
$I_{Max2p} = \frac{C_{max} \times U_{N(L-L)}}{Z_{(L-L)}}$	where	$Z_{(L-L)} = \sqrt{R_{(L-L)}^2 + X_{(L-L)}^2}$ $C_{max} = \begin{cases} 1.05; U_{N(L-L)} \pm 6 \% \\ 1.10; U_{N(L-L)} \pm 10 \% \end{cases}$
$I_{Min3p} = \frac{C_{min} \times U_{N(L-L)}}{\sqrt{3}} \frac{2}{Z_{(L-L)hot}}$	where	$Z_{(L-L)hot} = \sqrt{(1.5 \times R_{(L-L)})^2 + X_{(L-L)}^2}$ $C_{min} = \begin{cases} 0.95; U_{N(L-L)} \pm 6 \% \\ 0.90; U_{N(L-L)} \pm 10 \% \end{cases}$
$I_{Max3p} = \frac{C_{max} \times U_{N(L-L)}}{\sqrt{3}} \frac{2}{Z_{(L-L)}}$	where	$Z_{(L-L)} = \sqrt{R_{(L-L)}^2 + X_{(L-L)}^2}$ $C_{max} = \begin{cases} 1.05; U_{N(L-L)} \pm 6 \% \\ 1.10; U_{N(L-L)} \pm 10 \% \end{cases}$