



MI 3115 PV Analyser  
Instruction manual  
*Ver.1.1.1, code no. 20 753 336*

Distributor:

Manufacturer:

Metrel d.o.o.  
Ljubljanska cesta 77  
SI-1354 Horjul  
Slovenia  
[e-mail:info@metrel.si](mailto:info@metrel.si)  
<https://www.metrel.si>

DATA BACKUP AND LOSS:

It is the user's responsibility to ensure the integrity and security of the data carrier and to regularly backup and validate the integrity of backups of the data. METREL HAS NO OBLIGATION OR LIABILITY FOR ANY LOSS, ALTERATION, DESTRUCTION, DAMAGE, CORRUPTION OR RECOVERY OF USER DATA, REGARDLESS OF WHERE THE DATA IS STORED.



Mark on your equipment certifies that it meets requirements of all subjected EU regulations.



Hereby, Metrel d.o.o. declares that the MI 3115 is in compliance with Directive 2014/53/EU (RED) and all other subjected EU directive. The full text of the EU declaration of conformity is available at the following internet address <https://www.metrel.si/DoC>.



Mark on your equipment certifies that it meets requirements of all subjected UK regulations.



Hereby, Metrel d.o.o. declares that the MI 3115 is in compliance with Radio Equipment Regulations 2017 and all other subjected UK regulations. The full text of the UK declaration of conformity is available at the following internet address <https://www.metrel.si/UK-DoC>.

© Metrel d.o.o.

Published: 01/2024

*The trade names Metrel®, Smartec®, Eurotest®, Auto Sequence® are trademarks registered in Europe and other countries.*

No part of this publication may be reproduced or utilized in any form or by any means without permission in writing from METREL.

# TABLE OF CONTENTS

1	General description.....	6
1.1	Warnings and notes.....	6
1.1.1	Safety warnings .....	6
1.1.2	Warnings related to safety of measurement functions.....	7
1.1.3	Notes related to measurement functions .....	7
1.1.4	General notes.....	8
1.1.5	Markings on the instrument.....	8
1.2	Standards applied.....	9
2	Instrument set and accessories.....	10
2.1	Standard set of the instrument .....	10
2.2	Optional accessories .....	10
3	Instrument description.....	11
3.1	Front panel .....	11
4	Instrument operation .....	13
4.1	General meaning of keys.....	13
4.2	General meaning of touch gestures .....	14
4.3	Virtual keyboard .....	14
4.4	Safety checks, symbols, messages .....	15
4.4.1	Bluetooth and Wi-Fi connections.....	18
4.4.2	Terminal voltage monitor.....	18
4.4.3	Battery indication .....	19
4.5	Instrument main menu.....	19
4.6	General settings menu.....	20
4.6.1	Settings .....	21
4.6.2	Wi-Fi settings .....	22
4.6.3	Bluetooth initialization .....	22
4.6.4	Initial Settings .....	22
4.6.5	About.....	23
4.6.6	User Accounts.....	23
4.6.7	Managing accounts .....	24
4.7	Instrument profiles.....	25
4.8	Workspace Manager .....	25
4.8.1	Workspaces and Export.....	25
4.9	Auto Sequence® groups .....	27
4.10	PV modules.....	28
4.10.1	Operations on list of PV module.....	28
4.10.2	PV module configuration .....	28
4.10.3	Import of list of PV modules .....	29
5	Memory Organizer .....	30
5.1	Operations in Memory Organizer .....	30
5.1.1	Operations on Workspace .....	30

5.1.2	Operations on measurements .....	31
5.1.3	Measurement statuses .....	32
5.1.4	Operations on Structure objects.....	33
5.1.5	Searching in Memory Organizer.....	33
5.1.6	Changing PV modules and other parameters in already performed measurements .....	34
6	Single tests.....	36
6.1	Selection modes .....	36
6.2	Single test screens.....	36
6.2.1	Single test start screen .....	37
6.2.2	Single test screen during test.....	37
6.2.3	Single test result screen.....	38
6.2.4	Editing graphs .....	39
6.3	Single test (inspection) screens .....	39
6.3.1	Single test (inspection) start screen.....	40
6.3.2	Single test (Inspection) screen during test .....	40
6.3.3	Single test (Inspection) result screen .....	41
6.3.4	Help screens.....	42
6.4	Environmental data .....	42
6.4.1	On-line synchronization of environmental data between PV Remote WL and instrument .....	43
6.4.2	Synchronization of environmental data between PV Remote WL and instrument after the test .....	44
6.4.3	Manual entry of environmental data.....	45
6.5	Single test measurements.....	46
6.5.1	Visual inspection.....	46
6.5.2	R low, 200 mA resistance measurement.....	46
6.5.3	Compensation of test leads .....	47
6.5.4	Insulation resistance (Roc+, Roc-, Roc).....	47
6.5.5	Uoc/Isc.....	48
6.5.6	I/U curve .....	50
6.5.7	Automatic measurement – IEC 62446 Autotest.....	52
6.5.8	Environment .....	53
7	Auto Sequences® .....	55
7.1	Selection and searching of Auto Sequences .....	55
7.1.1	Organization of Auto Sequences® in Auto Sequences® menu .....	56
7.2	Auto Sequence.....	56
7.2.1	Auto Sequence® view menu .....	57
7.2.2	Indication of Loops .....	58
7.2.3	Managing multiple points .....	58
7.2.4	Step by step execution of Auto Sequences .....	58
7.2.5	Auto Sequence result screen.....	59
8	Maintenance.....	61
8.1	Periodic calibration .....	61
8.2	Service .....	61
8.3	Cleaning.....	61

---

9	Communications .....	62
9.1	USB and RS232 communication with PC.....	62
9.2	Communication with A 1785 – PV Remote WL.....	62
10	Technical specifications.....	64
10.1	Test and measurements .....	64
10.1.1	R ISO PV – Insulation resistance .....	64
10.1.2	R low - 200 mA resistance measurement .....	65
10.1.3	I/U curve tracking.....	65
10.1.4	Uoc/Isc measurements .....	66
10.1.5	Environmental parameters .....	67
10.2	General data .....	67
11	Appendix A - Remote operation.....	69
11.1	Metrel ES Manager .....	69
11.2	Black Box protocol .....	69
11.3	SDK.....	69
12	Appendix B - Structure objects .....	70
13	Appendix C - Profile Notes.....	71
14	Appendix D - PV measurements - calculated values.....	72

# 1 General description

## 1.1 Warnings and notes



### 1.1.1 Safety warnings

In order to reach high level of operator safety while carrying out various measurements using the PV Analyser instrument, as well as to keep the test equipment undamaged, it is necessary to consider the following general warnings.

- Read this instruction manual carefully, otherwise use of the instrument may be dangerous for the operator, for the instrument or for the equipment under test!
- Consider warning markings on the instrument!
- If the test equipment is used in manner not specified in this instruction manual the protection provided by the equipment may be impaired!
- Before conducting any tests or measurements, ensure that the PV strings intended for measurement are disconnected from the inverter.
- Do not use the instrument and accessories if any damage is noticed!
- Regularly check the instrument and accessories for correct functioning to avoid hazard that could occur from misleading results.
- Use only *Metrel* standard or optional test accessories!
- Consider all generally known precautions in order to avoid risk of electric shock while dealing with hazardous voltages!
- Instrument servicing and calibration is allowed to be carried out only by a competent authorized person!
- *Metrel* Auto Sequences® are designed as guidance to tests in order to significantly reduce testing time, improve work scope and increase traceability of the tests performed. *Metrel* assumes no responsibility for any Auto Sequence by any **means. It is the user's responsibility, to check adequacy for the purpose of use of the selected Auto Sequence.** This includes type and number of tests, sequence flow, test parameters and limits.
- PV sources can produce very high voltages and currents. Only skilled and trained personnel should perform measurements on photovoltaic systems.
- Safety precautions for working on the roof should be considered.
- In case of a fault in the measuring system (wires, devices, connections, measuring **instrument, accessories...), presence of flammable gases, very high moisture or heavy dust** an electrical arc can occur that will not extinguish by itself. Arcs can lead

to fire and can cause heavy damage. Users must be skilled to disconnect the PV system safely in this case.



- Do not use the instrument in PV systems with voltages higher than 1500 V d.c. and/or currents higher than 20 A d.c.! Otherwise, the instrument can be damaged.



- Do not connect external voltage between P/S and PE terminals. Max allowed voltage: < 10 V d.c., max allowed current: < 1 A d.c.! Otherwise, the instrument can be damaged.

### 1.1.2 Warnings related to safety of measurement functions

R low	Do never connect test leads to output of PV module / string!
R ISO PV IEC 62446 Autotest	Do not touch the test object during the measurement or before it is fully discharged! Risk of electric shock! When insulation resistance measurement has been performed on a capacitive object, automatic discharge may not be done immediately! The warning message and the actual voltage are displayed during discharge until voltage drops below 30 V.
I/U curve Uoc/Isc IEC 62446 Autotest	Do not disconnect the test terminals during the measurement. Risk of electric shock and/or arcs!

### 1.1.3 Notes related to measurement functions

R low	If a voltage of higher than 10 V (AC or DC) is detected between test terminals, the measurement will not be performed. Parallel loops may influence on test results.
R ISO PV	If external voltage is detected on the test terminals the instrument will check if conditions are appropriate for proceeding with the test. Appropriate notifications are displayed. Conditions for starting the test (regarding external voltage on test terminals): Type Riso=[Roc+, Roc-]:

	<p><math>0\text{ V} \leq U\text{ (DC+/DC-)} \leq 1500\text{ V}</math>  PE - not connected to DC+ or DC- <b>of string's output</b>  Type Riso=[Roc]:  <math>20\text{ V} \leq U\text{ (DC+/DC-)} \leq 1500\text{ V}</math>  PE - not connected to DC+ or DC- <b>of string's output</b>  At the end of test, capacitive objects are discharged to 30 V.</p>
IEC 62446 Autotest (Insulation)	<p>If external voltage is detected on the test terminals the instrument will check if conditions are appropriate for proceeding with the test. Appropriate notifications are displayed.  Conditions for starting the test (regarding external voltage on test terminals):  <math>20\text{ V} \leq U\text{ (DC+/DC-)} \leq 1500\text{ V}</math>  PE - not connected to DC+ or DC- <b>of string's output</b></p>
Uoc/Isc I/U curve IEC 62446 Autotest (Uoc/Isc)	<p>Conditions for starting the test (regarding external voltage on test terminals):  <math>20\text{ V} \leq U\text{ (DC+/DC-)} \leq 1500\text{ V}</math>  PE - not connected to DC+ or DC- <b>of string's output</b></p> <p>Consider correct environmental conditions and PV module data! Otherwise, nominal and STC data will be wrong / will not be calculated!</p>

### Hint

In case that wrong PV module data were used and (STC, nominal) results are wrong, the instrument enables to change the PV module after the test.

See chapter [Changing PV modules and other parameters in already performed measurements](#).

#### 1.1.4 General notes





- LCD screenshots in this document are informative only. Screens on the instrument may be slightly different.
- *Metrel* reserve the right to make technical modifications without notice as part of the further development of the product.

#### 1.1.5 Markings on the instrument



Read the Instruction manual with special care to safety operation«. The symbol requires an action!



	Mark on your equipment certifies that it meets requirements of all subjected EU regulations.
	Mark on your equipment certifies that it meets requirements of all subjected UK regulations.
	This equipment should be recycled as electronic waste.
	Instrument has double insulation.

## 1.2 Standards applied

The instrument is manufactured and tested according to the following regulations, listed below.

### Electromagnetic compatibility (EMC)

EN 61326-1	Electrical equipment for measurement, control and laboratory use - EMC requirements – Part 1: General requirements
------------	--

### Safety (LVD)

EN 61010-1	Safety requirements for electrical equipment for measurement, control, and laboratory use – Part 1: General requirements
EN 61010-2-030	Safety requirements for electrical equipment for measurement, control and laboratory use – Part 2-030: Particular requirements for testing and measuring circuits
EN 61010-031	Safety requirements for electrical equipment for measurement, control and laboratory use – Part 031: Safety requirements for hand-held probe assemblies for electrical measurement and test
EN 61557	Electrical safety in low voltage distribution systems up to 1000 V a.c. and 1500 V d.c. – Equipment for testing, measuring or monitoring of protective measures Instrument complies with all relevant parts of EN 61557 standards.

### Functionality

EN 62466-1	Photovoltaic (PV) systems. Requirements for testing, documentation and maintenance – Part 1: Grid connected systems – Documentation, commissioning tests and inspection
EN 62466-2	Photovoltaic (PV) systems. Requirements for testing, documentation and maintenance – Part 2: Grid connected systems – Maintenance of PV systems

## 2 Instrument set and accessories

### 2.1 Standard set of the instrument

- MI 3115 PV Analyser instrument
- Mains cable C13/schuko
- Carrying bag (L)
- Measurement lead, red, 3 m, banana/banana
- Measurement lead, blue, 3 m, banana/banana
- Measurement lead, green, 3 m, banana/banana
- Test lead, green, 4 m
- Test lead, black, 50 m, on cable reel
- Set PV MC4 to banana adapters
- Crocodile clip, green
- Test probe, 3 pcs, (black, red, blue)
- USB cable, 1 m, USB-A to USB-B
- MicroSD card
- A 1785 PV Remote WL
- PV reference monocrystal cell w/o adapter (A 1427 S2)
- PV Temperature probe w/o adapter (A 1400 S2)
- Rechargeable Ni-MH batteries, type AA, 1.2V, 2400 mAh, 6 pcs, (S 2125)
- Power supply adapter 12 V, 0.5 A
- Calibration certification
- PCSW METREL ES manager PRO
- Quick guide
- Instruction manual (on CD)
- Handbook (on CD)

See the attached sheet "[Included in the Set](#)".

### 2.2 Optional accessories

See the attached sheet for a list of optional accessories that are available on request from your distributor.

## 3 Instrument description

### 3.1 Front panel

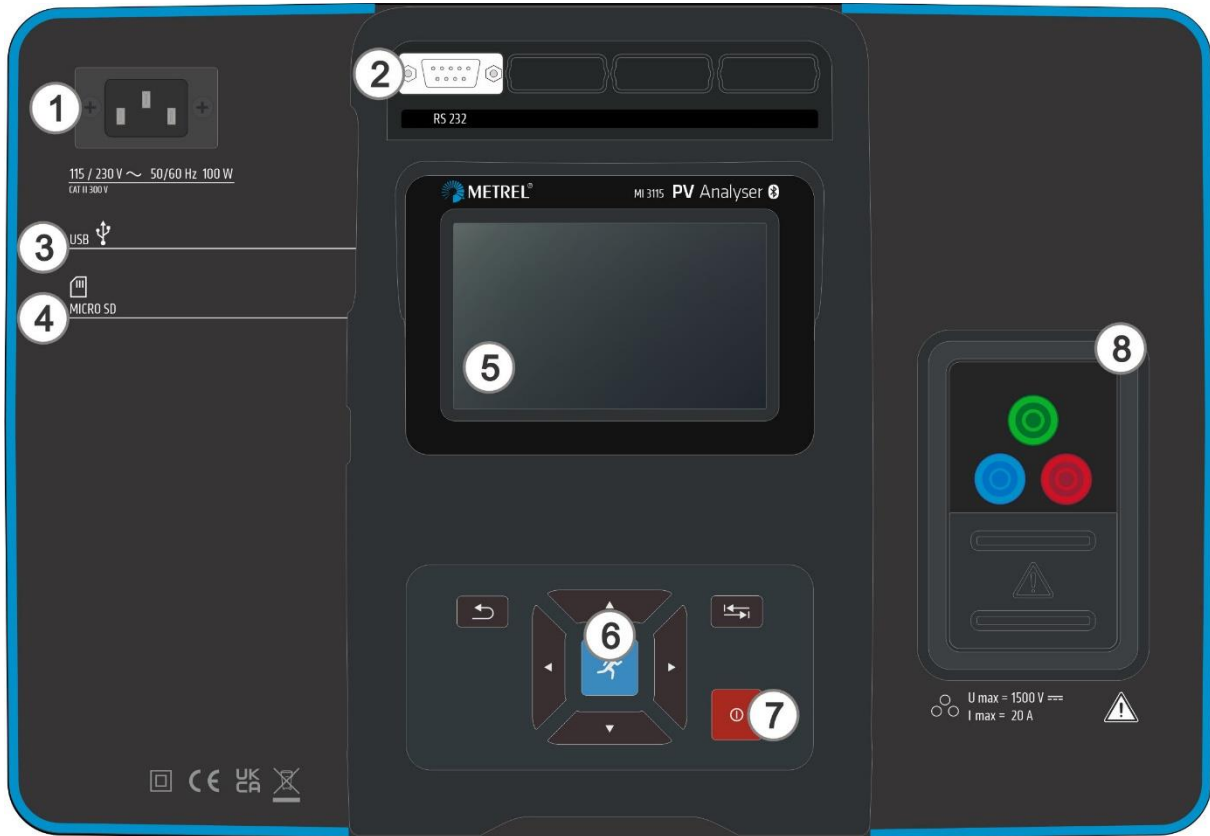

Test connector options:



- |   |                        |
|---|------------------------|
| 1 | Mains supply connector |
| 2 | Serial port            |
| 3 | USB communication port |
| 4 | MicroSD card slot      |
| 5 | Display                |

---

6	Keypad
7	ON/OFF key
8	Test connector
9	PE terminal
10	DC- terminal
11	DC+ terminal
12	Protection cover
13	P/S (probe) terminal

---

## 4 Instrument operation

The instrument can be manipulated via a keypad or touch screen.

### 4.1 General meaning of keys



ON / OFF key

Switch instrument on / off.

To switch off the instrument press key for 2 s.

The instrument automatically switches off after 10 minutes of idle state (no key pressed or any touch screen activity).

Reset instrument (long press >5 s).



Cursor keys are used to:

- Select appropriate option.
- Left, right, up, down.
- In some functions: page up, page down.



RUN key is used to:

- Confirm selected option.
- Start and stop measurements.



Escape key is used to:

- Return to previous menu without changes.
- Abort measurements.



Option key is used to:

- Expand column in control panel.
- Show detailed view of options.

## 4.2 General meaning of touch gestures

	<p>Tap (briefly touch surface with fingertip) is used to:</p> <ul style="list-style-type: none"> <li>• Select appropriate option.</li> <li>• Confirm selected option.</li> <li>• Start and stop measurements.</li> </ul>
	<p>Swipe (press, move, lift) up/ down is used to:</p> <ul style="list-style-type: none"> <li>• Scroll content in same level.</li> <li>• Navigate between views in same level.</li> </ul>
	<p>Long press (touch surface with fingertip for at least 1 s) is used to:</p> <ul style="list-style-type: none"> <li>• Select additional keys (virtual keyboard).</li> </ul>
	<p>Tap Escape icon is used to:</p> <ul style="list-style-type: none"> <li>• Return to previous menu without changes.</li> <li>• Abort / stop measurements.</li> </ul>

## 4.3 Virtual keyboard

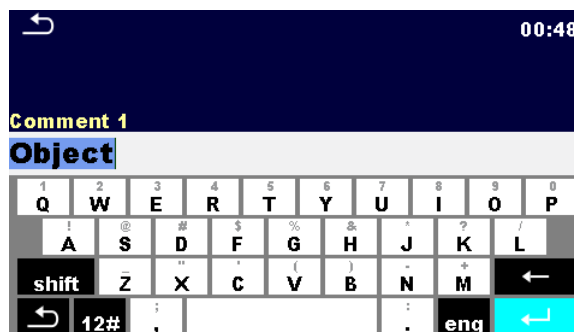

Options:



Toggle case between lowercase and uppercase.  
Active only when alphabetic characters' keyboard layout selected.



Backspace  
Clears last character or all characters if selected.  
(If held for 2 s, all characters are selected).



Enter confirms new text.



Activates numeric / symbols layout.



Activates alphabetic characters.



English keyboard layout.



Greek keyboard layout.



Russian keyboard layout.



Returns to the previous menu without changes.

#### Note

- If Backspace is held for 2 s, all characters will be selected.

#### Hint

Long press on some keys opens additional keys.

## 4.4 Safety checks, symbols, messages

At start up and during operation the instrument performs various safety checks to ensure safety and to prevent any damage. If a safety check fails, an appropriate warning message will be displayed and safety measures will be taken.

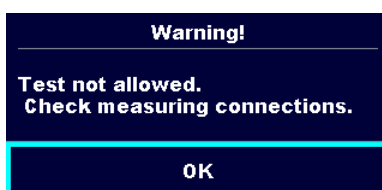

External voltage between DC+/PE or DC-/PE terminals

Insulation resistance test cannot be carried out.

- Possible reasons: connection to PV string's output

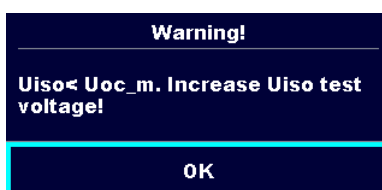

Insulation test voltage is lower than open circuit voltage of tested PV string.

Insulation resistance (Roc) test cannot be carried out.

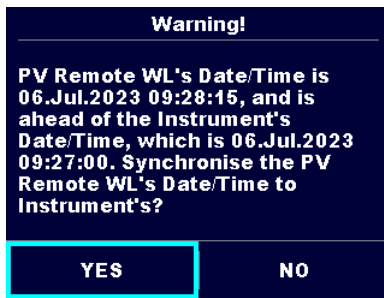

Time synchronization warning.

After confirmation A 1785 – PV Remote WL accepts time from instrument.

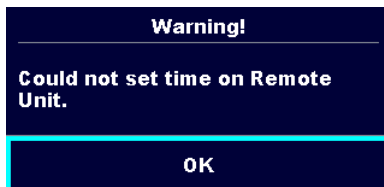

Warning that time synchronization is not possible while remote unit is logging.

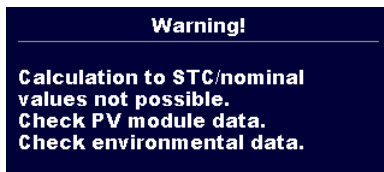

Warning that STC / nominal values cannot be calculated and displayed, due to missing or invalid PV module or environmental data.

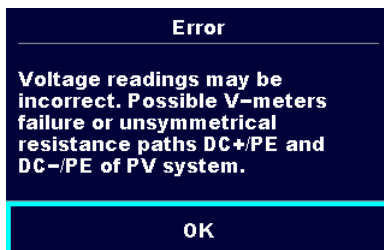

Voltage readings may be incorrect.

Possible causes:

- Input V-meters failure,
- unbalanced voltage DC+/PE or DC-/PE on PV system.

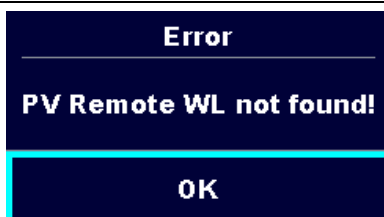

PV Remote WL not found during synchronization.

Possible reasons:

- PV Remote WL is turned off.
- No Wi-Fi connection between PV Remote WL and the instrument.
- Wi-Fi communication is out of range.

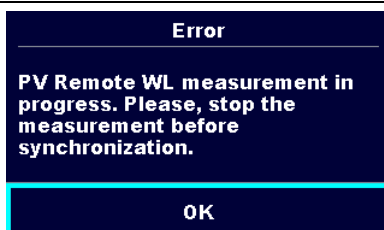

Synchronization of test results is not possible while remote unit is logging.





Measurement is running, consider displayed warnings.



Warning! A very high and dangerous voltage is / will be present on the instrument output!

The instrument automatically discharges tested object after finished insulation measurement.

When an insulation resistance measurement has been performed on a capacitive object, automatic discharge may not be done immediately! The warning symbol and the actual voltage are displayed during discharge until voltage drops below 30 V.



### WARNING

A high voltage is / will be present on the instrument terminals!  
(High test voltage or PV string voltage).



Unstable irradiance or too low irradiance  
( $Irr < Irr_{min}$ ).

Calculation to STC is not possible.



$\Delta U_{oc} > \Delta U_{oc\_warning}$ .

Check module type and number of modules.



DC+ and DC- connections are reversed.



AC voltage is detected on measuring terminals.



Blown fuse



The instrument is overheated. The **measurement can't be carried out until the icon disappears.**



Test leads resistance in R low measurement is not compensated.



Test leads resistance in R low measurement is compensated.



Test passed.  
Result is inside predefined limits.



Test failed.  
Result is out of predefined limits.



Measurement is aborted. Consider displayed warnings and messages.  
In R ISO PV and IEC 62446 Autotest function Roc calculation will only be performed, if the test time (duration) elapsed without the user stopping it.



Conditions on the input terminals allow starting the measurement; consider other displayed warnings and messages.



Conditions on the input terminals do not allow starting the measurement, consider displayed warnings and messages.



Stop the measurement.

### Hint

For some icons more information is displayed if  on icon.

#### 4.4.1 Bluetooth and Wi-Fi connections



Bluetooth communication active.  
Bluetooth icon is displayed during data transfer only.



Wi-Fi communication with PV Remote WL inactive.



Wi-Fi communication with PV Remote WL active.  
Wi-Fi signal strength is indicated.

#### 4.4.2 Terminal voltage monitor

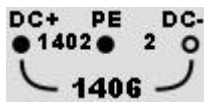

The terminal voltage monitor displays voltage and active test terminals indication. PE terminal should also be connected for correct input voltage condition.

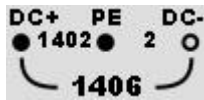

DC+ and PE are active test terminals.

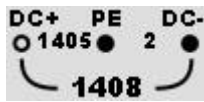

DC- and PE are active test terminals.



DC+ and DC- are active test terminals.

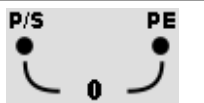

Active test terminals for R low measurement.

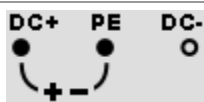

Polarity of test voltage applied to the output terminals.

#### 4.4.3 Battery indication

The battery indication indicates the charge condition of battery and connection to a.c. power supply.



Battery is in good condition.



Battery is full.



Low battery.

Battery is too weak to guarantee correct result. Recharge the battery.



Empty battery or no battery.



Charging in progress (if instrument connected to a.c. power supply).



Charging finished.

## 4.5 Instrument main menu

From the instrument Main Menu four main operation menus can be selected.

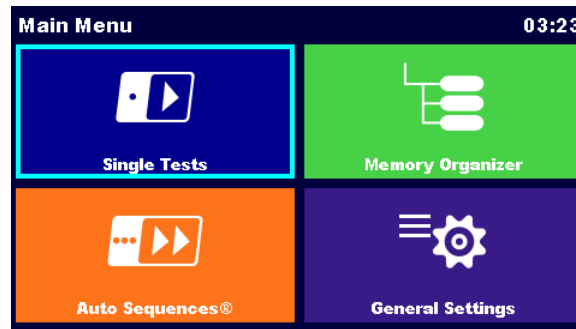

Single Test	Menu for selecting single tests
Auto Sequences®	Menu for selecting Auto sequences
Memory Organizer	Menu for working with structured test objects and measurements
General Settings	Menu for setup of the instrument

## 4.6 General settings menu

In the General Settings menu general parameters and settings of the instrument can be viewed or set.

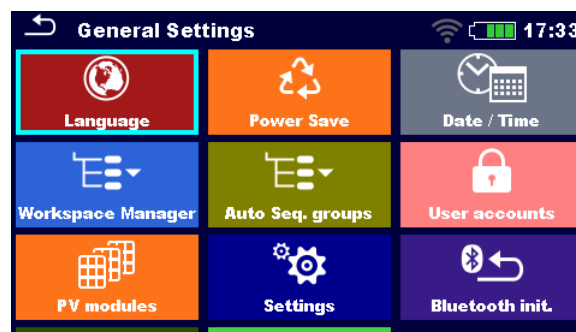

Language	Language selection
Power Save	Brightness of LCD, LCD off timer, enabling/disabling Bluetooth communication
Date / Time	Setting date and time
Workspace Manager	Managing project files
Auto Sequence® groups	Managing lists of Auto Sequences®
User accounts	Managing user accounts
PV modules	Managing PV modules
Profiles	Instrument profiles (This setting is visible only if more than one profile is available.)

Settings	Setting different system and measuring parameters
Bluetooth init.	Bluetooth / Wi-Fi modul initialization
Initial Settings	Factory settings
About	Instrument data

#### 4.6.1 Settings

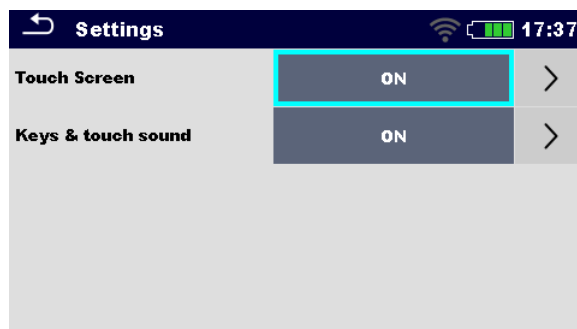

Touch screen	Set Touch screen on / off.
Keys & touch sound	Set key touch sound on / off.

### 4.6.2 Wi-Fi settings

Refer to chapter [Communication with A 1785 – PV Remote WL](#) and [A 1785 – PV Remote WL Instruction manual](#) for detailed information.

### 4.6.3 Bluetooth initialization

In this menu internal Bluetooth / Wi-Fi module is reset.

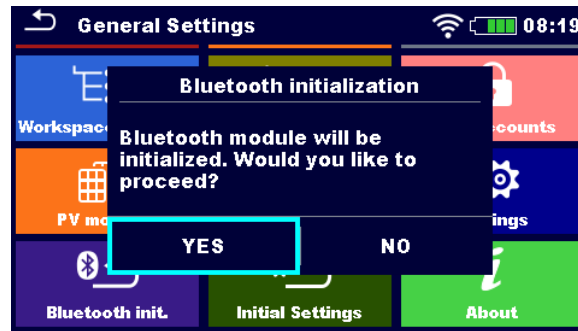

### 4.6.4 Initial Settings

In this menu internal Bluetooth / Wi-Fi module will be initialized and the instrument settings, measurement parameters and limits will be set to initial (factory) values.

#### WARNING

Following customized settings will be lost when setting the instruments to initial settings:

- Measurement limits and parameters.
- Global parameters and System settings.
- Opened Workspace and Auto Sequence® group will be deselected.
- User will be signed out.

#### Note

Following customized settings will stay:

- Profile settings
- Data in memory (Data in Memory organizer, Workspaces, Auto Sequence® groups and Auto Sequences®)
- User accounts

### 4.6.5 About

In this menu instrument data (name, serial number, FW (firmware) and HW (hardware) version, profile code, HD (hardware documentation) version, and date of calibration) can be viewed.

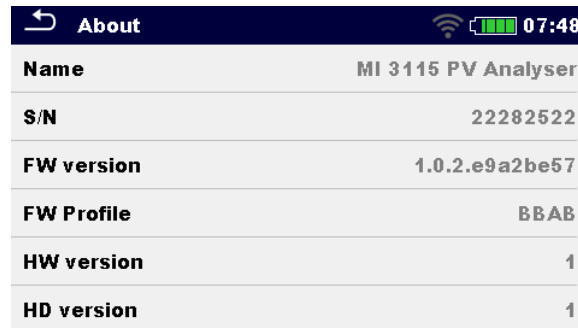

About	
<b>Name</b>	MI 3115 PV Analyser
<b>S/N</b>	22282522
<b>FW version</b>	1.0.2.e9a2be57
<b>FW Profile</b>	BBAB
<b>HW version</b>	1
<b>HD version</b>	1

### 4.6.6 User Accounts

The instrument has a User Accounts system. Following actions can be managed:

- Setting if signing in to work with the instrument is required or not.
- Adding and deleting new users, setting their user names and passwords.
- Setting the password for allowing Black Box operation.

Default passwords

<b>'ADMIN'</b>	The default account manager password
Second account manager password	This password is delivered with the instrument and always unlocks the Account manager
Empty (disabled)	By default, no password needs to be entered for Black Box operation

#### Note

- If a user account is set and the user is signed in the user's name will be stored for each measurement.

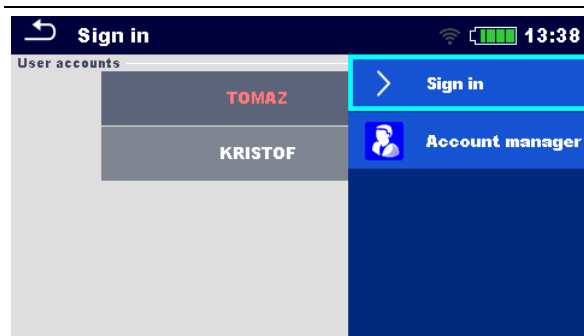

Sign in as user: Select User, Sign in, change user Password.

Sign in as administrator: Select Account manager, set account manager Password.

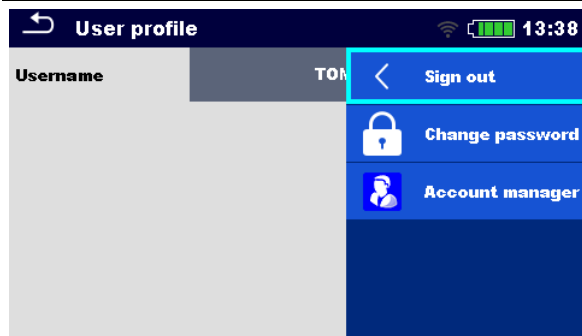

User sign out: select Sign out

Change user password (individual users can change their password): Select Change password, set new password.

Account manager sign out: is automatic by exiting the Account manager menu.

### 4.6.7 Managing accounts

User Accounts can be managed by the Account manager.

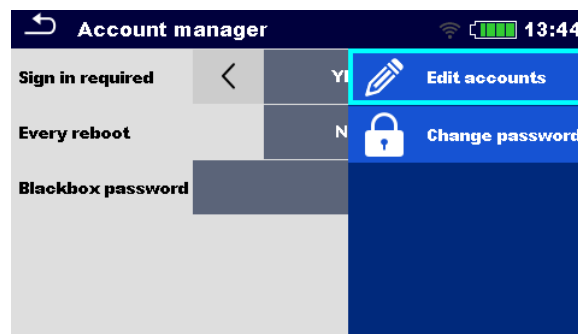

Sign in required	Require signing in
Every reboot	Sign in is required once, or at each reboot of the instrument
Change password	Change account manager password. Password is case sensitive.
Blackbox password	Set Black Box password (same password is valid for all users)

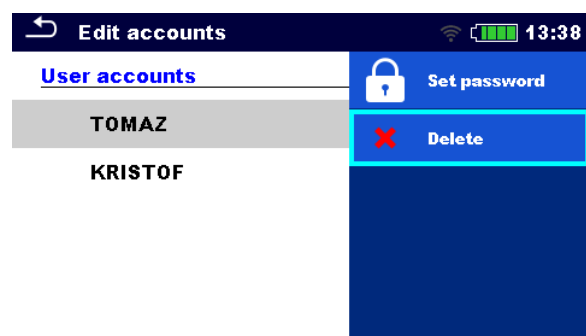
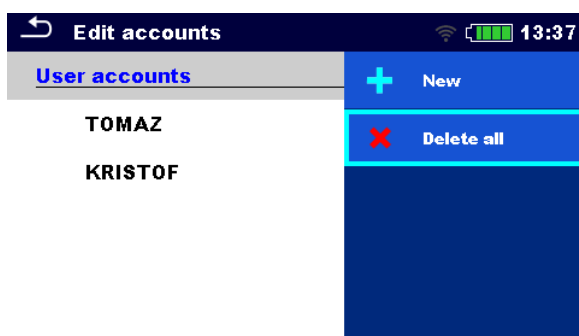

Add new user	Header line (User accounts), New, add name and password
Delete all users	Header line (User accounts), Delete all
Delete user	Select user, Delete
<b>Change user's password</b>	Select user, Set password



## 4.7 Instrument profiles

The instrument uses specific system and measuring settings in regard to the scope of work or country it is used. These specific settings are stored in instrument profiles. By default, each instrument has at least one profile activated. Proper licence keys must be obtained to add more profiles to the instrument. See [Appendix C - Profile Notes](#) for more information about functions specified by profiles.

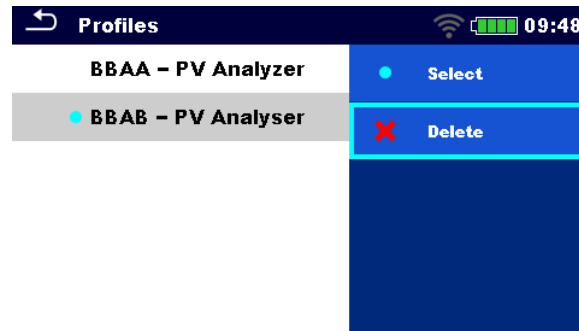

Select	Select profile
Delete	Delete profile

### Note

- This menu is visible only if more than one profile is available.

## 4.8 Workspace Manager

The Workspace Manager is intended to manage with different Workspaces and Exports stored on the microSD card.

### 4.8.1 Workspaces and Export

The works can be organized with help of Workspaces and Exports. Both Exports and Workspaces contain all relevant data (measurements, parameters, limits, structure objects) of an individual work.

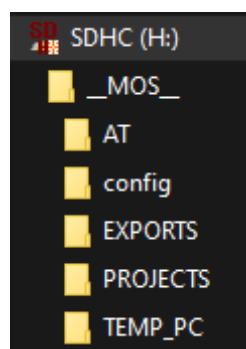

Workspaces are stored on microSD card on directory PROJECTS, while Exports are stored on directory EXPORTS. Export files can be read by Metrel applications that run on other devices. Exports are suitable for making backups of important works or can be used for storage of works if the removable microSD card is used as a mass storage device. To work on the instrument an Export should be imported first from the list of Exports and converted to a Workspace. To be stored as Export data a Workspace should be exported first from the list of Workspaces and converted to an Export. In the Workspace manager menu Workspaces and Exports are displayed in two separated lists.

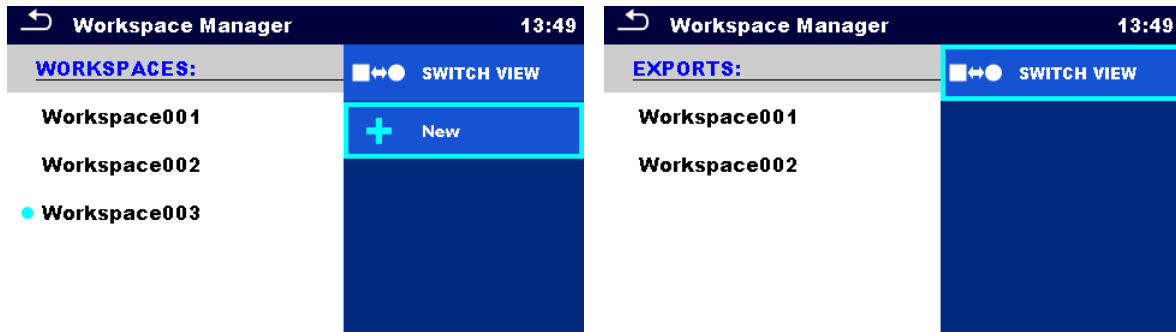

Header line (Workspaces, Exports), Switch View	Switch between Exports and Workspaces
---	---------------------------------------

Header line (Workspaces), New	Add new Workspace
-------------------------------	-------------------

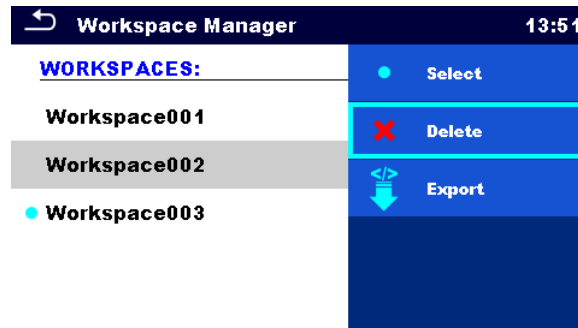

Select	Open selected Workspace in Memory Organizer
--------	---

Delete	Delete selected Workspace
--------	---------------------------

Export	Export selected Workspace into an Export
--------	--

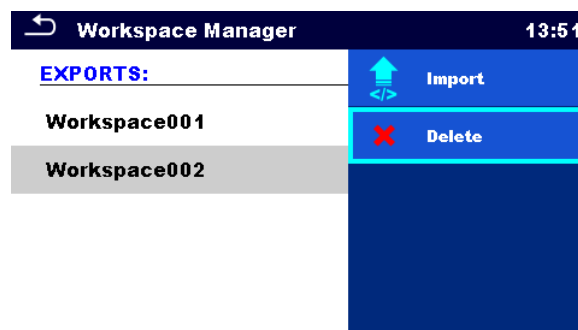

Import	Import selected Export to a Workspace
Delete	Delete selected Export

## 4.9 Auto Sequence® groups

The Auto Sequences in the instrument can be organized by using lists. In a list a group of similar Auto Sequences is stored. The Auto Sequence® groups menu is intended to manage with different lists. Folders with lists of Auto Sequences are stored in *Root\\_\_MOS\_\_\AT* on the microSD card.

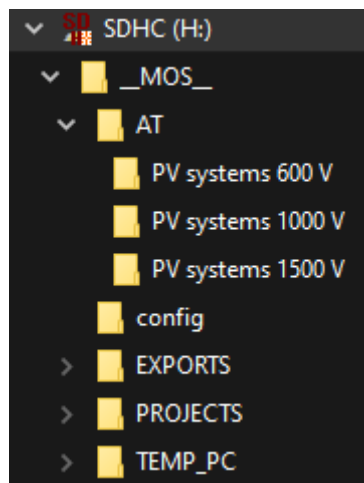

In Auto Sequence® group's menu lists of Auto Sequences® are displayed.

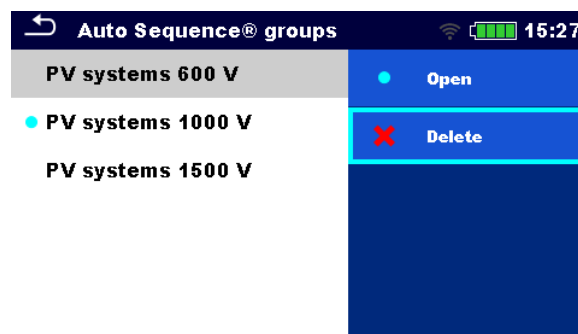

Open	Open the selected Auto Sequence group in the Auto Sequences® main menu.
Delete	Delete the selected Auto Sequence group.

## 4.10 PV modules

In this menu a list of PV modules and their data can be managed. The PV modules data from this list is used in measurements, for calculation of nominal and STC results.

### 4.10.1 Operations on list of PV module

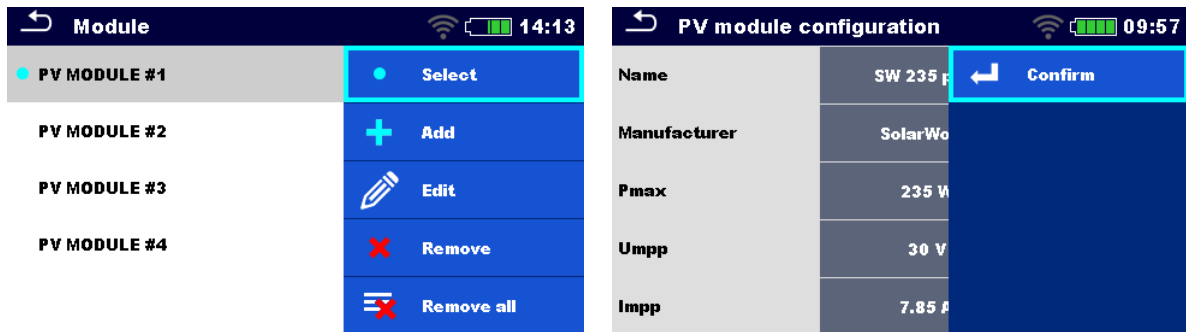

Select	Select PV module
Add	Add a new PV module
Edit	Go to menu for editing selected module / Edit PV module's data
Remove	Remove selected PV module
Remove all	Delete entire list of PV modules
Confirm	New module or edited data confirmation

### 4.10.2 PV module configuration

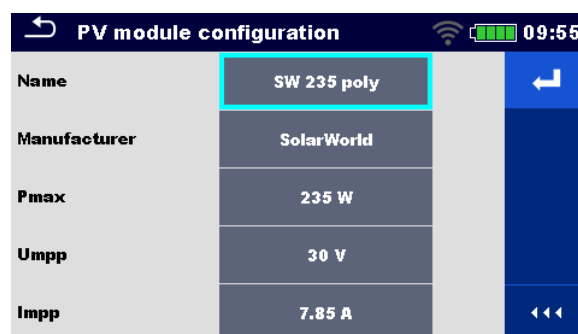

## Parameters of PV module

Module	PV module name For more information see <a href="#">PV module configuration</a> .
Manufacturer	PV module manufacturer
Pmax	Nominal power of PV module
Umpp	Voltage at maximum power point
Impp	Current at maximum power point
Uoc	Open-circuit voltage
Isc	Short-circuit current
NOCT	Normal operating cell temperature
Alpha	Temperature coefficient of Isc (A/°C)
Beta	Temperature coefficient of Uoc (V/°C)
Gamma	Temperature coefficient of Pmax (%/°C)
Rs	Serial resistance of PV module

## 4.10.3 Import of list of PV modules

The list of PV modules can also be prepared in Metrel ES Manager and imported to the instrument. Refer to [Metrel ES Manager Instruction manual](#) for detailed information.

## WARNING

- After upload, list of PV modules on instrument will be overwritten!

## 5 Memory Organizer

Memory Organizer is an environment for storing and working with test data. The data is organized in a multilevel tree structure with Structure objects and Measurements. For a list of available structure objects see [Appendix B - Structure objects](#).

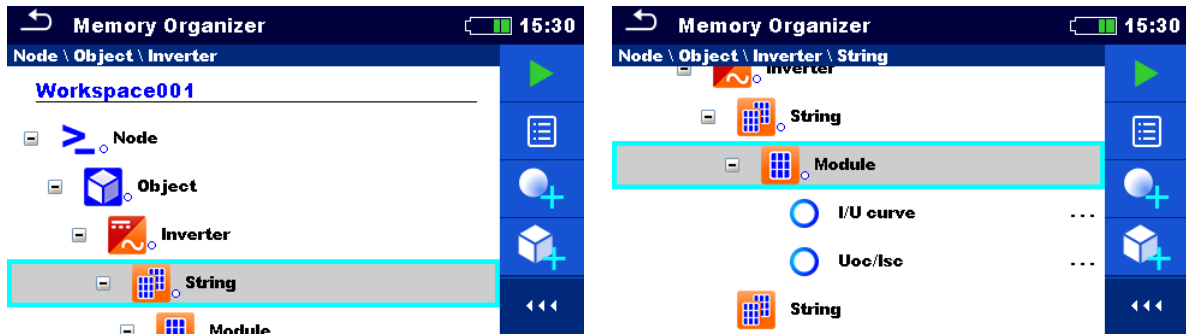

### 5.1 Operations in Memory Organizer

#### 5.1.1 Operations on Workspace

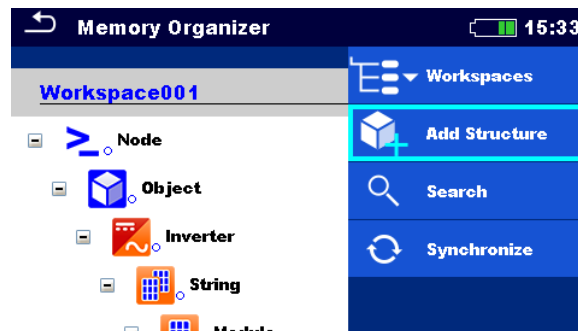

Header line (Workspace), Workspaces	Go to Workspace Manager from Memory Organizer
Header line (Workspace), Search	Search for structure elements
Node:	
Node is the highest-level structure element. One Node is a must; others are optional and can be created or deleted freely.	
Add a new node	Header line (Workspace), Add structure
Synchronize	All PV measurements synchronized with environmental data from PV Remote WL.

### 5.1.2 Operations on measurements

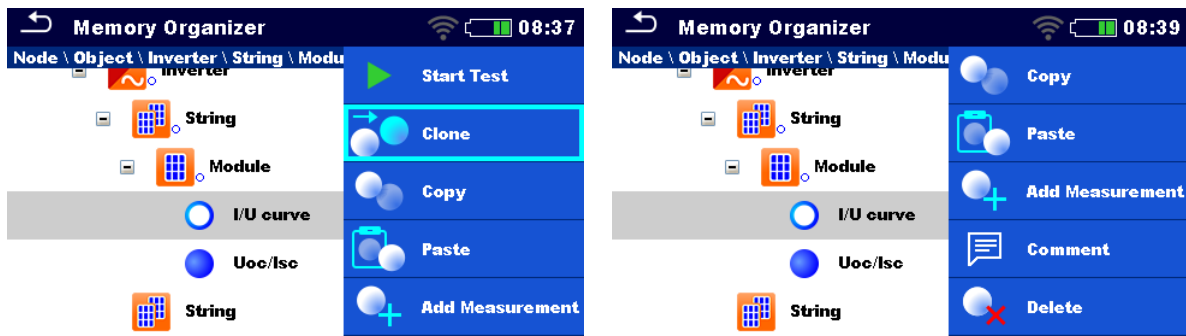

Start Test	Start a new measurement
Clone	Copy selected measurement as an empty measurement under the same Structure object
Copy, Paste	Copy a selected measurement as an empty measurement to any location in structure tree
Add Measurement	Add an empty measurement
Comment	Add / view a comment to the measurement
Delete	Delete a measurement
Retest, Start Test	Run a new measurement or Auto Sequence with same settings as selected measurement

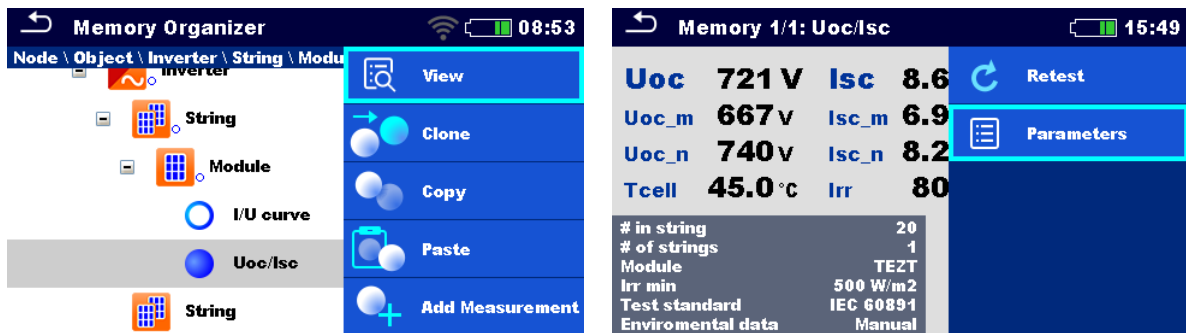

View	Enter menu for viewing details of Single test or Auto Sequence
Parameters	View / edit parameters
Retest	Run a new measurement or Auto Sequence with same settings as selected measurement





**Hint**

When a new empty measurement is added (single test or Auto sequence) the PV module selected in the belonging object will be adopted by default. If needed, it is possible to change the PV module and its number in the measurement.









### 5.1.3 Measurement statuses

Measurement statuses indicate the status of a measurement or a group of measurements in the Memory Organizer.

#### Statuses of Single tests

	Passed finished single test with test results
	Failed finished single test with test results
	Finished single test with test results and no status
	Empty single test without test results





#### Overall statuses of Auto Sequence

 or 	At least one single test in the Auto Sequence passed and no single test failed
 or 	At least one single test in the Auto Sequence failed
 or 	At least one single test in the Auto Sequence was carried out and there was no other passed or failed single tests
 or 	Empty Auto Sequence with empty single tests

#### Overall status of measurements under structure elements

Overall status of measurements under each structure element gives a fast information on tests without expanding tree menu.

#### Options

	There are no measurement result(s) under selected structure object. Measurements should be made.
	One or more measurement result(s) under selected structure object has failed. Not all measurements under selected structure object have been made yet.
	All measurements under selected structure object are completed but one or more measurement result(s) has failed.
	No status indication if all measurement results under each structure element / sub-element have passed or are without measurements.



### 5.1.4 Operations on Structure objects

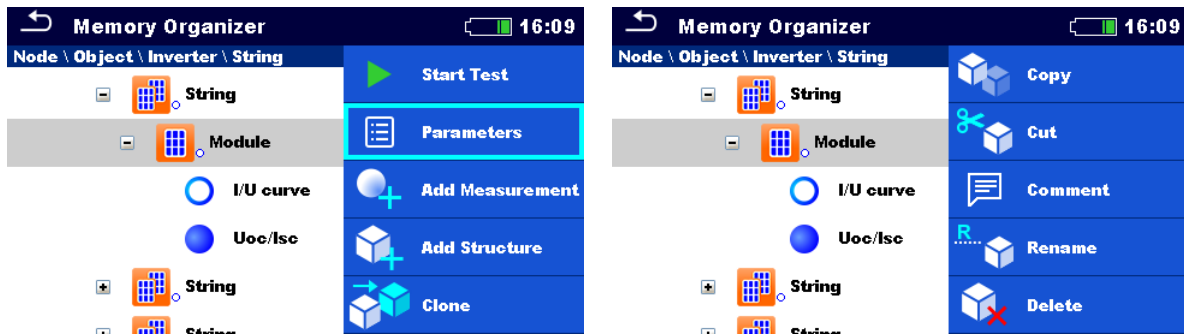

Start Test	Start a new measurement (proceeds to menus for selection of measurement)
Parameters	View / edit parameters
Add Measurement	Add a new empty measurement. Menu for adding new measurement will open
Add Structure	Add a new structure element
Clone	Copy selected element as to same level in the structure tree
Copy, Paste	Copy selected element to any allowed location in structure tree
Cut, Paste	Move selected Structure with child items (sub-structures and measurements) to any allowed location in structure tree
Attachment	View link of attachment
Comment	View/edit/add a comment to the structure element
Rename	Rename the structure element
Delete	Delete the structure element
Synchronize	<i>Update environmental data in measurements under selected object and its childs. STC and nominal test results will be changed. See <a href="#">Synchronization of environmental data between PV Remote WL and instrument after the test.</a></i>

### 5.1.5 Searching in Memory Organizer

In Memory organizer it is possible to search for different structure objects and their statuses.

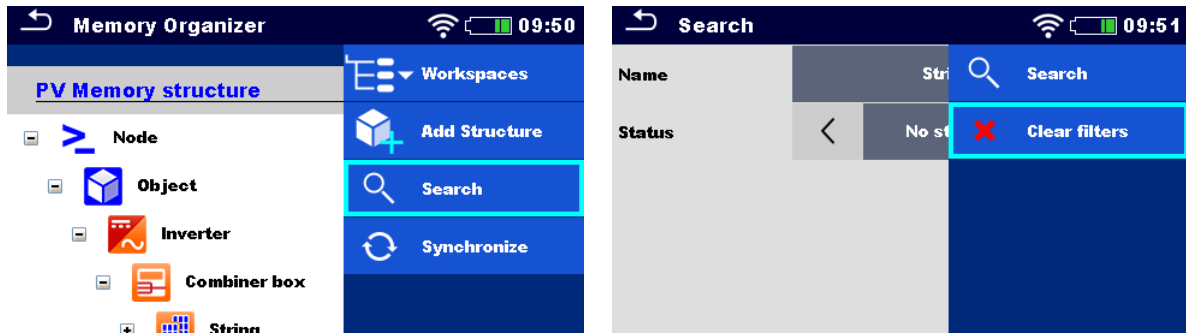

Header line (Workspace), Search	Enter Search menu
Search	Search according to structure element name and status
Clear filters	Clear set filters in Search menu

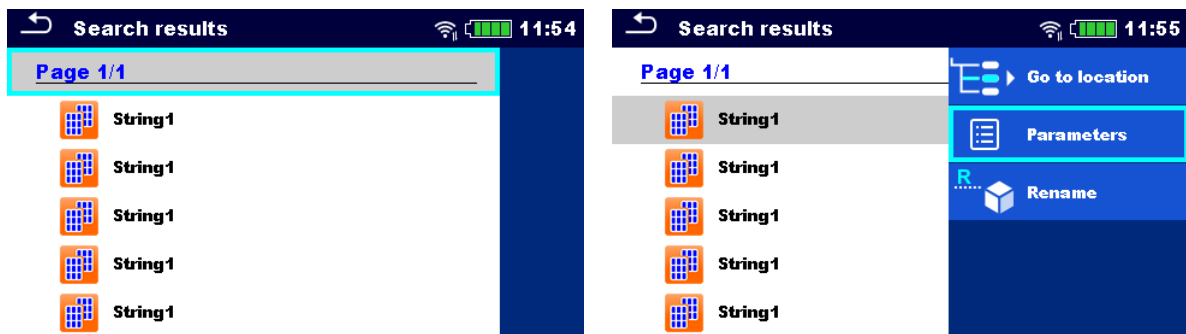

Operations on found structure objects	
Header line (Page x/y), Next Page, Previous Page	Go Page Up / Down
Go to location	Jump to selected location in Memory organizer
Parameters	View/edit parameters
Rename	Rename the found object

### 5.1.6 Changing PV modules and other parameters in already performed measurements

In Memory Organizer it is possible to change PV module type, number of modules in PV string and number of PV strings in already finished measurements. For example, this feature enables to get correct STC and nominal test results in case wrong PV module data and/or number of PV modules and/or number of PV strings were selected for the measurement.

#### Procedure on selected object

In selected object in Memory Organizer, enter Parameters to edit Module. Select new module from the list.

All PV measurements under selected object and its **child's** will be updated.

- Nominal and STC values will change accordingly.

Measured data and environmental data will stay the same.

After update is finished, confirmation with number of updated structures and measurements is displayed.

All updated structures and measurements are saved automatically. Undo is not possible.

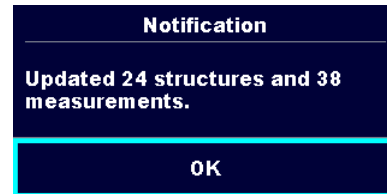
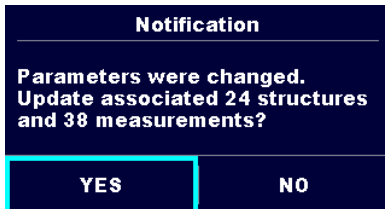

#### Procedure on selected measurement

In selected measurement in Memory Organizer, enter Parameters to edit:

- Module,
- Number of modules in PV string and
- Number of PV strings.

Measurement will be updated after confirmation.

- Nominal and STC values will change accordingly.

Measured data and environmental data will stay the same.

Save updated measurement results or undo modifications.

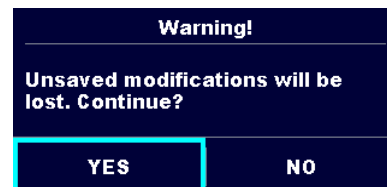
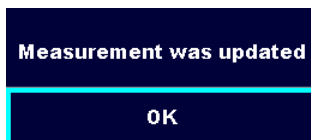

## 6 Single tests

### 6.1 Selection modes

In single test main menu two modes for selecting single tests are available.

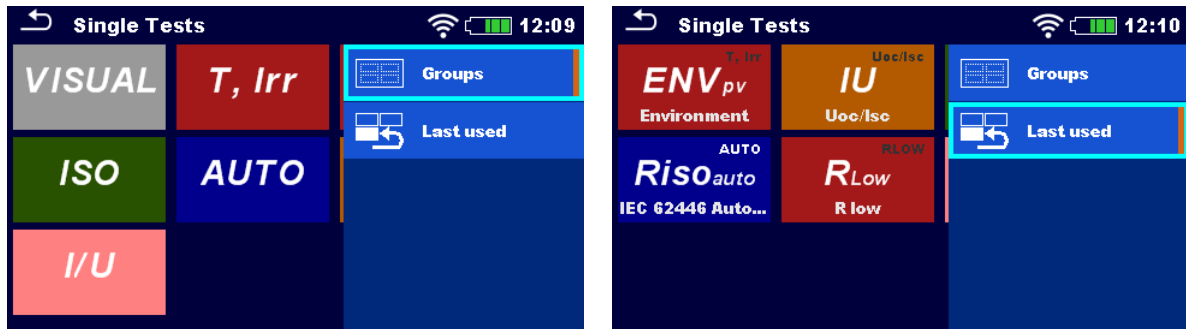

Groups	View groups of similar tests
Last used	View last made measurements

### 6.2 Single test screens

In the Single test screens main measuring results, sub-results, limits and parameters of the measurement are displayed. In addition, on-line statuses, warnings and other information are displayed.

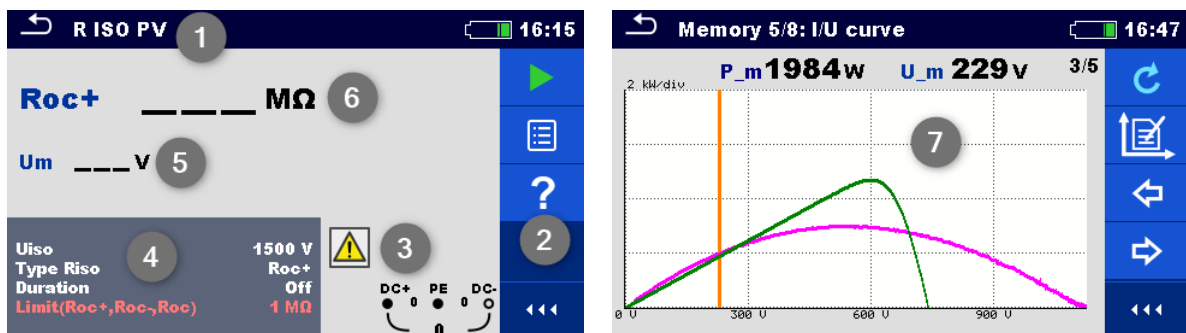

1	Name of single test function
2	Options
3	Terminal voltage, statuses, info, warnings
4	Parameters (white) and limits (red)
5	Sub-result
6	Main result
7	Graph

### 6.2.1 Single test start screen



Start test	Start single test
Parameters, or tap on Parameters field	Set parameters/ limits of single test
Prev	Previous screen
Next	Next screen
Calibrate	Compensation of test leads (R low)
Help	View help screens

Add comments before the test (applicable on R low only): In the Parameters menu comments can be stored as a part of the single test Parameters, Comment 1, Comment 2.

### 6.2.2 Single test screen during test

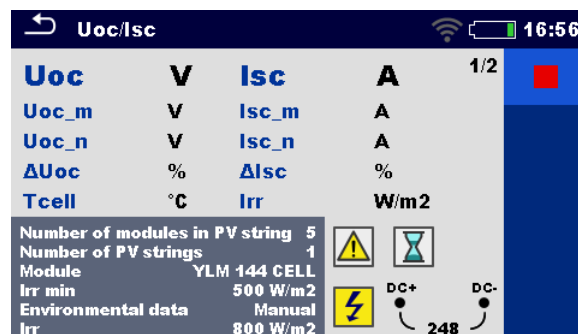

End single test

Testing procedure (during the test)

Observe the displayed results and statuses

Check for eventual messages, warnings

## 6.2.3 Single test result screen

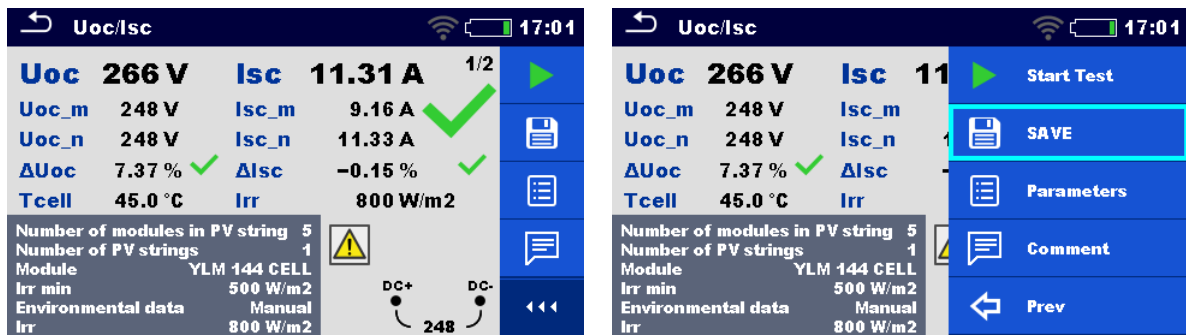

Start test	Start a new single test
Save	Save the result
A new measurement was started from a Structure object in the structure tree	The measurement will be saved under the selected Structure object
A new measurement was started from the Single test main menu	Saving under the last selected Structure object will be offered by default. The user can select another Structure object or create a new Structure object. By pressing the Save key in Memory organizer menu the measurement is saved under selected location.
An empty measurement was selected in Memory Organizer and started	The result(s) will be added to the measurement. The measurement will <b>change its status from 'empty' to 'finished'</b> .
An already carried out measurement was selected in Memory Organizer, viewed and then restarted	A new measurement will be saved under the selected Structure object.
Prev	Previous screen
Next	Next screen
Plot edit	Editing graphs
Comment	Add comment to the measurement

### 6.2.4 Editing graphs

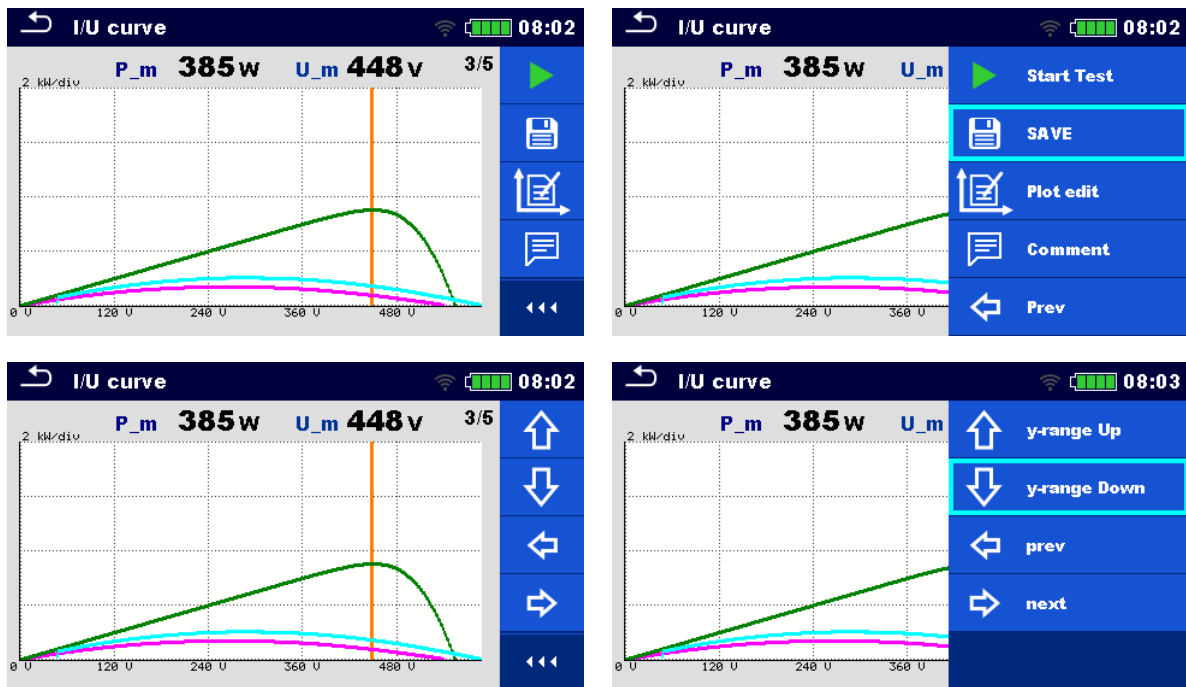

Options for editing graphs (start screen or after measurement is finished)

Plot edit	Open control panel for editing graphs
y-range Up	Increase scale factor for y-axis
y-range Down	Decrease scale factor for y-axis
Prev	Move cursor left on x-axis
Next	Move cursor right on x-axis

### 6.3 Single test (inspection) screens

Visual inspections are a special type of single tests. Items to be visually checked are displayed. Appropriate statuses can be applied.

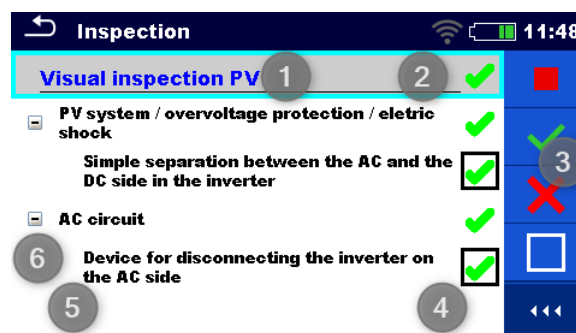

1	Selected inspection name
---	--------------------------

2	Overall status
3	Options
4	Status fields
5	Child items
6	Item

### 6.3.1 Single test (inspection) start screen

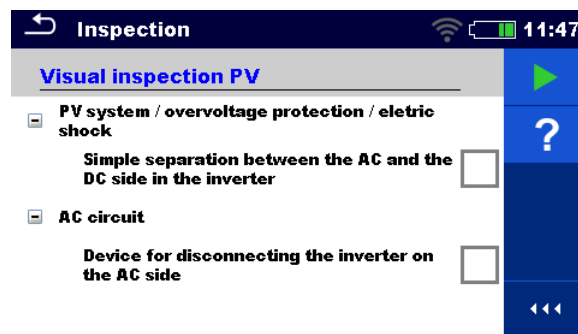

Start test	Start the inspection
Help	View help screens

### 6.3.2 Single test (Inspection) screen during test

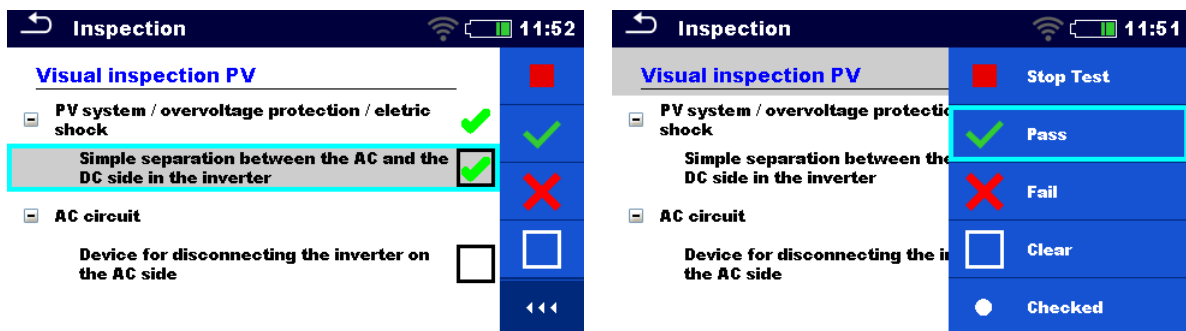

Header line (name of inspection), apply Pass or Fail or Checked or Clear	Apply or clear the overall status to complete inspection
Select group of items, apply Pass or Fail or Checked or Clear	Apply or clear the status of group of items
Select items, apply Pass or Fail or Checked or Clear	Apply or clear the status of an individual item



**Hint**

Tap on  or use  key to set status.

**Rules for automatic applying of statuses**

The parent items will automatically get a status on base of statuses in child items

- The fail status has highest priority. A fail status for any item will result in a fail status in all parent items and an overall fail result.
- If there is no fail status in child items the parent item will get a status only if all child items have a status.
- Pass status has priority over checked status.

The child items will automatically get a status on base of status in the parent item

All child items will get the same status as applied to the parent item

**Note**

- Inspections and even inspection items inside one inspection can have different **status types**. For example, some inspections don't have the 'checked' status.
- Only inspections with an overall status can be saved.

**6.3.3 Single test (Inspection) result screen**

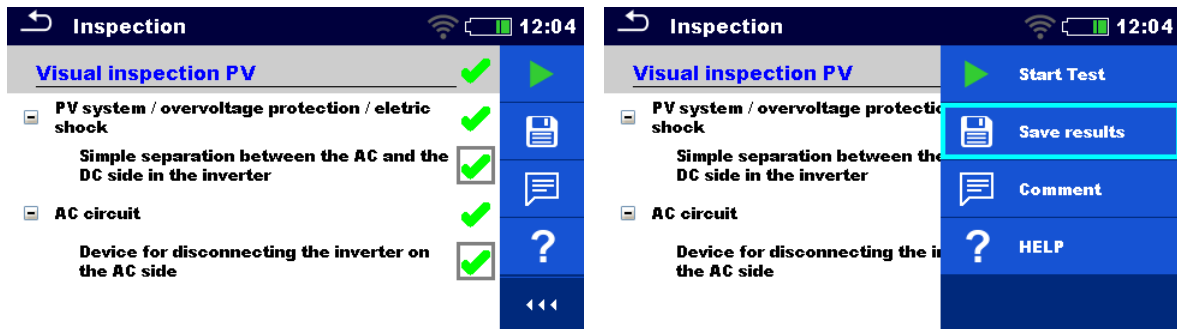

Start test	Start a new inspection
Save results	Save the result
Comment	Add comment to the inspection
Help	View help screens

A new inspection was started from a Structure object in the structure tree      The inspection will be saved under the selected Structure object.

A new inspection was started from the Single test main menu      Saving under the last selected Structure object will be offered by default. The user

	can select another Structure object or create a new Structure object. By pressing the Save key in Memory organizer menu the inspection is saved under selected location.
An empty inspection was selected in Memory Organizer and started	The result(s) will be added to the inspection. The inspection will change its status from 'empty' to 'finished'.
An already carried out inspection was selected from Memory Organizer, viewed and then restarted	A new inspection will be saved under the selected Structure object.

### 6.3.4 Help screens

Help screens contain diagrams for proper connection of the instrument.

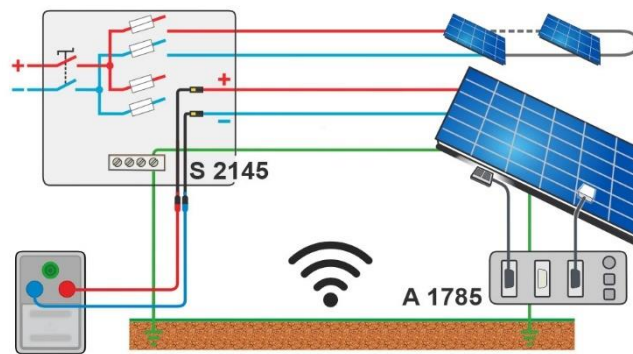

Help	Open help screen
	Go to other help screens

## 6.4 Environmental data

Environmental data are measured with the A 1785 – PV Remote WL with sensors mounted on the PV modules. The instrument is usually in another location (at the inverter, combiner box). For getting STC results, the environmental data from the PV remote WL and measurements on the instrument must be combined. Date & time synchronization between the instrument and A 1785 - PV Remote WL is automatic, during Wi-Fi connection and when the instrument is switched on. For this purpose, the instrument and the PV Remote WL shall be wirelessly connected.

The best working practice is to establish a permanent on-line wireless connection between the A 1785 PV remote WL and the instrument during the tests.

If the wireless connection is established between the PV remote WL and the instrument during the PV test the environmental data from the remote unit will be automatically sent to the instrument and considered in the test.

See [On-line synchronization of environmental data between PV Remote WL and instrument](#).

If there is no wireless connection with the PV remote WL during the PV test, it is possible to log the environmental data with the A 1785 PV Remote WL and synchronize the environmental data later. For the measurement on the instrument, manually entered environmental data will be considered, if data from PV Remote WL is not available. The measured environmental data with PV Remote WL, can be downloaded to the instrument and synchronized with selected saved measurements anytime later.

See [Synchronization of environmental data between PV Remote WL and instrument after the test](#).

#### 6.4.1 On-line synchronization of environmental data between PV Remote WL and instrument

Following data measured with PV remote will be automatically synchronized during the measurement on the instrument:

Irr	Irradiance at time of measurement
Tcell	PV cell temperature at time of measurement
Tcell (5 min)	PV cell temperature 5 min before test
Tcell (10 min)	PV cell temperature 10 min before test
Tcell (15 min)	PV cell temperature 15 min before test
Tamb	Ambient temperature at time of measurement

#### Note

- Only environmental data available at a time of measurement are sent to instrument. Data like Tcell (5 min), Tcell (10 min) and Tcell (15 min) are available after specific time after start logging.

#### Procedure

In single test starting menu switch *Environmental data* parameter to *Remote*.

Before the test, check that Wi-Fi connection between PV remote WL and instrument is established.

PV remote WL must be logging environmental data. For more information see [PV Remote WL Instruction manual](#).

After the test, check the results on the instrument.

### 6.4.2 Synchronization of environmental data between PV Remote WL and instrument after the test

Following data are logged with PV remote WL and can be synchronized with the instrument later:

Irr	Irradiance at time of measurement
Tcell	PV cell temperature at time of measurement
Tcell (5 min)	PV cell temperature 5 min before test
Tcell (10 min)	PV cell temperature 10 min before test
Tcell (15min)	PV cell temperature 15 min before test
Tamb	Ambient temperature at time of measurement

#### Procedure

In single test starting menu switch *Environmental data* parameter to *Manual*.

Assure that PV Remote WL is logging environmental data.

After the finished and saved measurements, establish Wi-Fi connection between PV Remote WL and instrument.

In Memory Organizer, select actual Workspace or structure element and select Synchronize.

All PV measurements

- in selected workspace or selected structure element, including sub-structures,
- with no or manually entered environmental data,

will be updated.

*Environmental data* parameter of synchronized measurements will change from *Manual* to *Remote*.

After data is synchronized, confirmation with number of updated measurements is displayed.

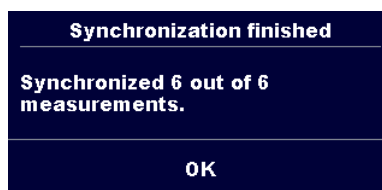

#### Notes

- **The user doesn't need to care about** correct Date & time synchronization between PV remote WL and the instrument. Date & time is automatically synchronized at each successful Wi-Fi connection. However, it is recommended to regularly check the Date & time on PV Remote WL.

- If PV Remote WL time is ahead of the **instrument's time warning message** is displayed.
- Once a PV measurement was updated with valid data from the PV Remote WL, further updates are not possible.

### Hint

- It is recommended to perform automatic Date & time synchronization before start logging environmental data on PV solar field. To automatically perform Date & time synchronization, place instrument and PV Remote unit close to each other and switch them both on.

### 6.4.3 Manual entry of environmental data

Following data can be entered manually before the test:

Irr	Irradiance [Custom, 800 W/m <sup>2</sup> ]
Tcell	PV cell temperature [Custom, 45.0 °C]
Tamb	Ambient temperature [Custom, 25.0 °C]

#### Procedure

In single test starting menu switch *Environmental data* parameter to *Manual*.

Select/enter environmental data.

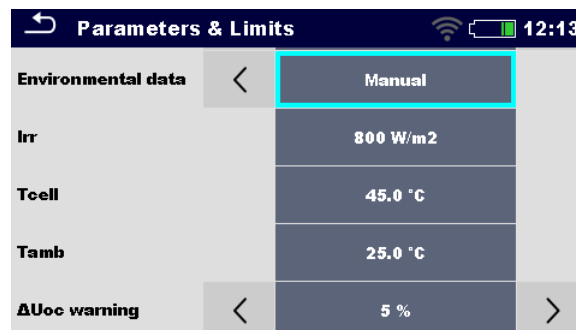

The manually entered environmental data will be used for calculation of STC results until they are updated (synchronized) with measured data from PV Remote WL.

#### Indication of manually entered environmental data

Parameter Environmental data indicates the way how environmental data were entered for selected measurement.

Once the stored measurements from selected workspace are synchronized/updated with data from A 1785 - PV Remote WL, parameter Environmental data is changed from *Manual* to *Remote*.

## Note

- If user doesn't change data before the test, latest stored data will be considered.

## 6.5 Single test measurements

### 6.5.1 Visual inspection

Test results / sub-results

Pass, Fail, Checked

Test circuit

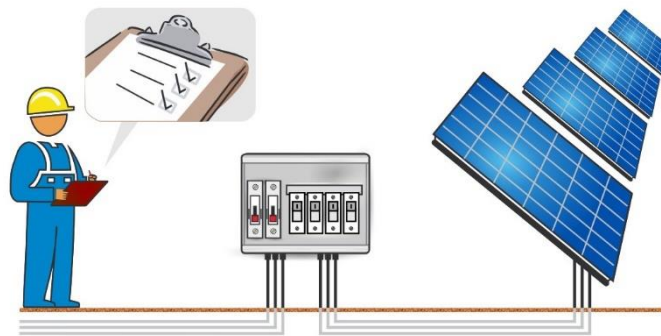

### 6.5.2 R low, 200 mA resistance measurement

Test results / sub-results

R	Resistance
R+	Result at positive test polarity
R-	Result at negative test polarity

Test parameters

Comment 1	User comment
Comment 2	User comment

Test limits

Limit (R)	Limit (R) [Off, Custom, 0.05 $\Omega$ ... 20.0 $\Omega$ ]
-----------	---

Additional options

Calibrate	Calibrate – see <a href="#">Compensation of test leads</a> .
-----------	--

Test circuits

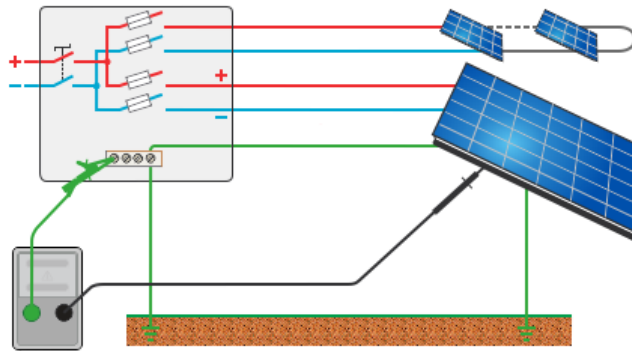

6.5.3 Compensation of test leads

- Resistance of test lead(s) and cables can be compensated. Compensation is possible in R low function.

Connection for compensating the resistance of test leads

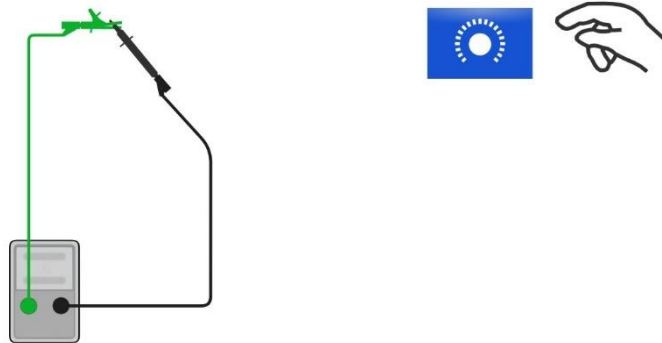

Procedure for compensation of test leads

Select single test and its parameters.

Connect test leads in short-circuit to P/S and PE banana sockets.

Calibrate: Compensate test lead resistance

Symbol  is displayed and a short beep sounds, if the compensation was carried out successfully.

6.5.4 Insulation resistance (Roc+, Roc-, Roc)

Test results / sub-results

Roc+	Insulation resistance between DC+ and PE
Roc-	Insulation resistance between DC- and PE
Roc	Calculated insulation resistance

Um	Test voltage
Uoc_m	Measured open-circuit voltage
Test parameters	
Nominal test voltage	Uiso [250 V, 500 V, 1000 V, 1500 V]
Type of test	Type Riso [Roc+, Roc-, Roc]
Duration	Duration [Off, 5 s ... 60 s]
Test limits	
Limit (Roc+)	Low limit (Roc+) [Off, Custom, 10 k $\Omega$ ... 100 M $\Omega$ ]
Limit (Roc-)	Low limit (Roc-) [Off, Custom, 10 k $\Omega$ ... 100 M $\Omega$ ]
Limit (Roc)	Low limit (Roc) [Off, Custom, 10 k $\Omega$ ... 100 M $\Omega$ ]

## Test circuits

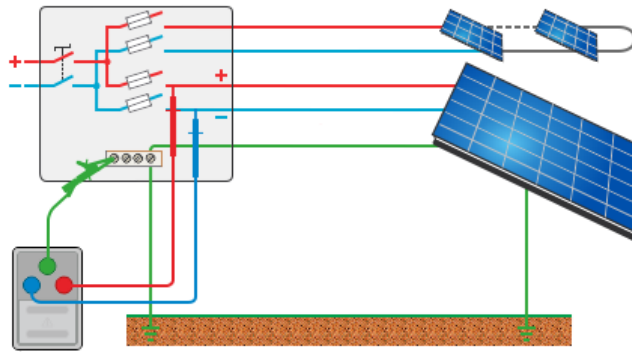

## 6.5.5 Uoc/Isc

## Test results / sub-results

Uoc_m	Measured open-circuit voltage
Isc_m	Measured short-circuit current
Uoc	Open-circuit voltage (STC)
Isc	Short-circuit current (STC)
Uoc_n	Open-circuit voltage (nominal)
Isc_n	Short-circuit current (nominal)
$\Delta$ Uoc	Relative change of Uoc
$\Delta$ Isc	Relative change of Isc
Irr	Irradiance at time of measurement or manual entry
Tcell	PV cell temperature at time of measurement or manual entry



Tcell (5 min)	PV cell temperature 5 min before test
Tcell (10 min)	PV cell temperature 10 min before test
Tcell (15min)	PV cell temperature 15 min before test
Tamb	Ambient temperature at time of measurement or manual entry

## Test parameters

Number of modules in PV string	Number of PV modules in series [Custom, 1 ... 50]
Number of PV strings	Number of PV modules / strings in parallel [Custom, 1 ... 4]
Module	PV module name Parameters Manufacturer, Pmax, Umpp, Impp, Uoc, Isc, NOCT, alpha, beta, gamma, Rs are visible. For more information see <a href="#">PV module configuration</a> .
Irr min	Minimal valid solar irradiance for calculation [Custom, 500 W/m <sup>2</sup> ... 1000 W/m <sup>2</sup> ]
Environmental data	Environmental data mode [Remote, Manual]
Irr <sup>1)</sup>	Irradiance [Custom, 800 W/m <sup>2</sup> ]
Tcell <sup>1)</sup>	PV cell temperature [Custom, 45.0 °C]
Tamb <sup>1)</sup>	Ambient temperature [Custom, 25.0 °C]
Tcell correction	Correction of measured cell temperature to compensate for the difference between the actual cell temperature and the measured temperature. [Off, 1 °C ... 5 °C]. According to the EN 61829 standard the difference is typically 2 °C.
$\Delta U_{oc}$ warning	Limit for the improper $\Delta U_{oc}$ warning [Off, 5 % ... 50 %]

<sup>1)</sup> User settable when Environmental data = [Manual].

## Test limits

$\Delta U_{oc}$ limit ( $\Delta U_{oc}$ )	High limit ( $\Delta U_{oc}$ ) [Off, Custom, 5 % ... 50 %]
$\Delta I_{sc}$ limit ( $\Delta I_{sc}$ )	High limit ( $\Delta I_{sc}$ ) [Off, Custom, 5 % ... 50 %]

## Test circuit

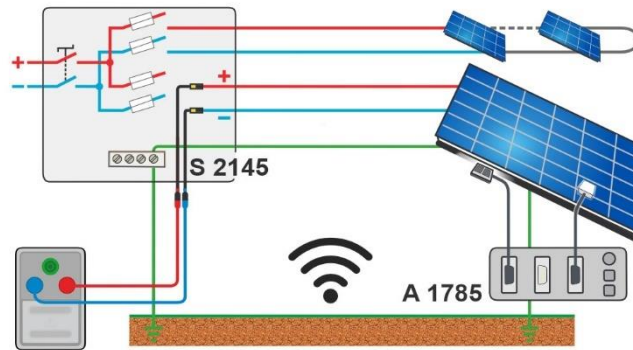

### 6.5.6 I/U curve

#### Test results / sub-results

Uoc_m	Measured open-circuit voltage
Isc_m	Measured short-circuit current
Umpp_m	Measured voltage (MPP)
Impp_m	Measured current (MPP)
Pmpp_m	Measured maximum power point
Uoc	Open-circuit voltage (STC)
Isc	Short-circuit current (STC)
Umpp	Voltage (MPP, STC)
Impp	Current (MPP, STC)
Pmpp	Maximum power point (STC)
Uoc_n	Open-circuit voltage (nominal)
Isc_n	Short-circuit current (nominal)
Umpp_n	Voltage (MPP, nominal)
Impp_n	Current (MPP, nominal)
Pmpp_n	Maximum power point (nominal)
Irr	Irradiance at time of measurement or manual entry
Tcell	PV cell temperature at time of measurement or manual entry
Tcell (5 min)	PV cell temperature 5 min before test
Tcell (10 min)	PV cell temperature 10 min before test
Tcell (15min)	PV cell temperature 15 min before test
Tamb	Ambient temperature at time of measurement or manual entry
<b>ΔUoc</b>	Relative change of Uoc

<b><math>\Delta I_{sc}</math></b>	Relative change of $I_{sc}$
<b><math>\Delta U_{mpp}</math></b>	Relative change of $U_{mpp}$
<b><math>\Delta I_{mpp}</math></b>	Relative change of $I_{mpp}$
<b><math>\Delta P_{mpp}</math></b>	Relative change of $P_{mpp}$
<b>FF_m</b>	Measured fill factor
FF_n	Fill factor (nominal)

### Graphs

I/U (measured)	Measured I/U curve
P/U (measured)	Measured P/U curve
I/U (STC)	I/U curve (STC)
P/U (STC)	P/U curve (STC)
I/U (nom)	I/U curve (nominal)
P/U (nom)	P/U curve (nominal)

### Test parameters

Number of modules in PV string	Number of PV modules in series [Custom, 1 ... 50]
Number of PV strings	Number of PV modules / strings in parallel [Custom, 1 ... 4]
Module	PV module name. Parameters: Manufacturer, $P_{max}$ , $U_{mpp}$ , $I_{mpp}$ , $U_{oc}$ , $I_{sc}$ , NOCT, alpha, beta, gamma, $R_s$ are visible. For more information see <a href="#">PV module configuration</a> .
Irr min	Minimal valid solar irradiance for calculation [Custom, 500 W/m <sup>2</sup> ... 1000 W/m <sup>2</sup> ]
Environmental data	Environmental data mode [Remote, Manual]
Irr <sup>1)</sup>	Irradiance [Custom, 800 W/m <sup>2</sup> ]
Tcell <sup>1)</sup>	PV cell temperature [Custom, 45.0 °C]
Tamb <sup>1)</sup>	Ambient temperature [Custom, 25.0 °C]
Tcell correction	Correction of measured cell temperature to compensate for the difference between the actual cell temperature and the measured temperature. [Off, 0 °C ... 5 °C]. According to the EN 61829 standard the difference is typically 2 °C.
<b><math>\Delta U_{oc}</math> warning</b>	Limit for the improper $\Delta U_{oc}$ warning [Off, 5 % ... 50 %]

<sup>1)</sup> User settable when Environmental data = [Manual].

## Test limit

$\Delta P_{mpp}$ limit ( $\Delta P_{mpp}$ )	High limit ( $\Delta P_{mpp}$ ) [Off, Custom, 5 % ... 50 %]
---	---

## Test circuit

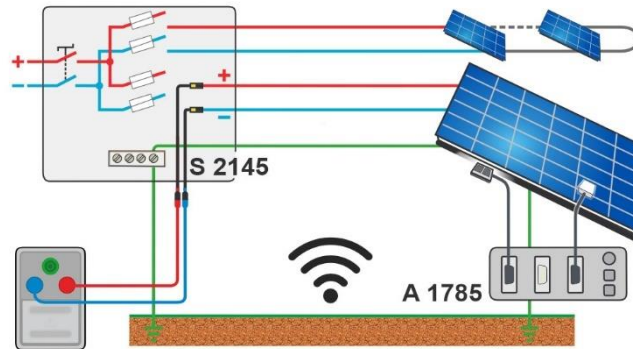

## 6.5.7 Automatic measurement – IEC 62446 Autotest

## Test results / sub-results

Roc+	Insulation resistance between DC+ and PE
Roc-	Insulation resistance between DC- and PE
Roc	Calculated insulation resistance
Um	Test voltages
Uoc_m	Measured open-circuit voltage
Isc_m	Measured short-circuit current
Uoc	Open-circuit voltage calculated to STC values
Isc	Short-circuit current calculated to STC values
$\Delta U_{oc}$	Relative change of Uoc
$\Delta I_{sc}$	Relative change of Isc
Irr	Irradiance at time of measurement or manual entry
Tcell	PV cell temperature at time of measurement or manual entry
Tcell (5 min)	PV cell temperature 5 min before test
Tcell (10 min)	PV cell temperature 10 min before test
Tcell (15min)	PV cell temperature 15 min before test
Tamb	Ambient temperature at time of measurement or manual entry

## Test parameters

Uiso	Nominal test voltage [250 V, 500 V, 1000 V, 1500 V]
------	---

Duration	Duration [5 s ... 60 s]
Number of modules in PV string	Number of PV modules in series [Custom, 1 ... 50]
Number of PV strings	Number of PV modules / strings in parallel [Custom, 1 ... 4]
Module	PV module name Parameters: Manufacturer, Pmax, Umpp, Impp, Uoc, Isc, NOCT, alpha, beta, gamma, Rs are visible. For more information see <a href="#">PV module configuration</a> .
Irr. min	Minimal valid solar irradiance for calculation [Custom, 500 W/m <sup>2</sup> ... 1000 W/m <sup>2</sup> ]
Environmental data	Environmental data mode [Remote, Manual]
Irr <sup>1)</sup>	Irradiance [Custom, 800 W/m <sup>2</sup> ]
Tcell <sup>1)</sup>	PV cell temperature [Custom, 45.0 °C]
Tamb <sup>1)</sup>	Ambient temperature [Custom, 25.0 °C]
Tcell correction	Correction of measured cell temperature to compensate for the difference between the actual cell temperature and the measured temperature. [Off, 1 °C ... 5 °C]. According to the EN 61829 standard the difference is typically 2 °C.
$\Delta U_{oc}$ warning	Limit for the improper $\Delta U_{oc}$ warning [Off, 5 %... 50 %]
<sup>1)</sup> User settable when Environmental data=[Manual].	

## Test limits

Limit (Roc)	Low limit (Roc) [Off, Custom, 10 k $\Omega$ ... 100 M $\Omega$ ]
$\Delta U_{oc}$ limit ( $\Delta U_{oc}$ )	High limit ( $\Delta U_{oc}$ ) [Off, Custom, 5 % ... 50 %]
$\Delta I_{sc}$ limit ( $\Delta I_{sc}$ )	High limit ( $\Delta I_{sc}$ ) [Off, Custom, 5 % ... 50 %]

## Test circuit

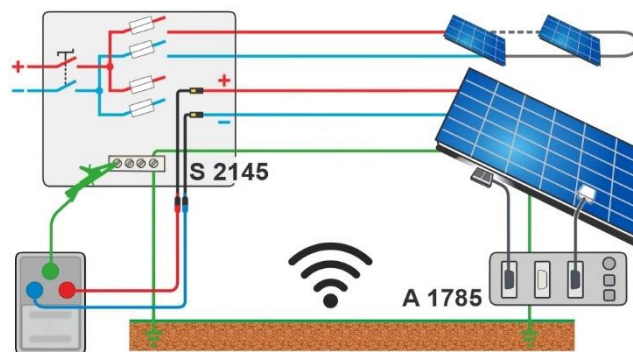

## 6.5.8 Environment

## Test results / sub-results

---

Irr	Irradiance at time of measurement
Tcell	PV cell temperature at time of measurement
Tamb	Ambient temperature at time of measurement
Tcell (5 min)	PV cell temperature 5 min before test
Tcell (10 min)	PV cell temperature 10 min before test
Tcell (15 min)	PV cell temperature 15 min before test

---

Test circuit

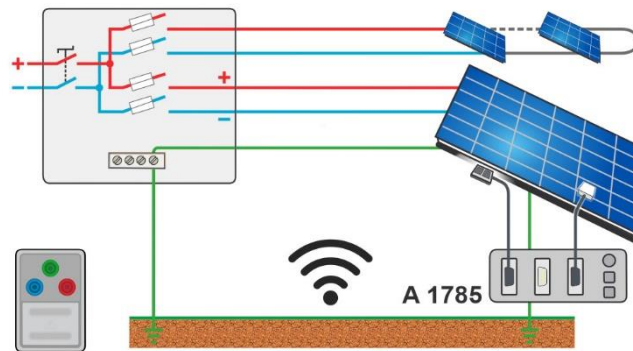

## 7 Auto Sequences®

Auto Sequences® are pre-programmed sequences of measurements. The Auto Sequences can be pre-programmed on PC with the Metrel ES Manager software and uploaded to the instrument. On the instrument, parameters and limits of individual single test in the Auto Sequence can be changed / set.

### 7.1 Selection and searching of Auto Sequences

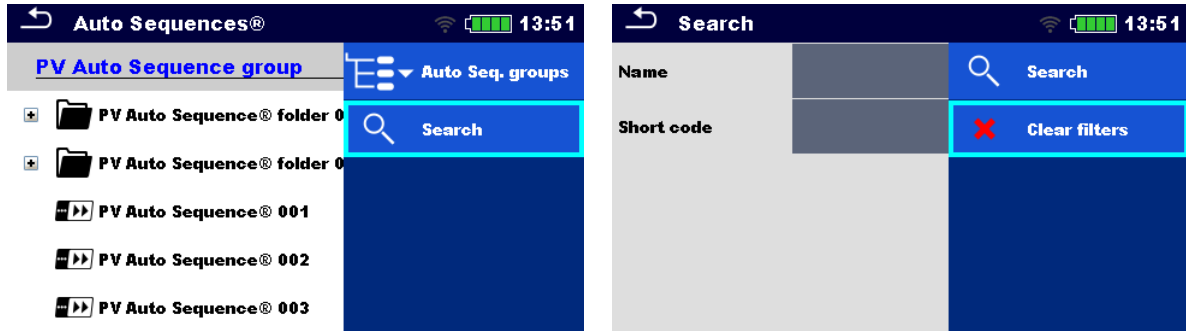

Selecting an Auto Sequence list in Auto Sequence groups menu

Go to Auto Sequence® groups menu	Header line (Auto Sequence list), Auto Seq. groups
----------------------------------	--

Searching of Auto Sequences

Search for Auto Sequence	Header line (Auto Sequence list), Search, set filters (Name or Short code)
Clear filters	Clear filters

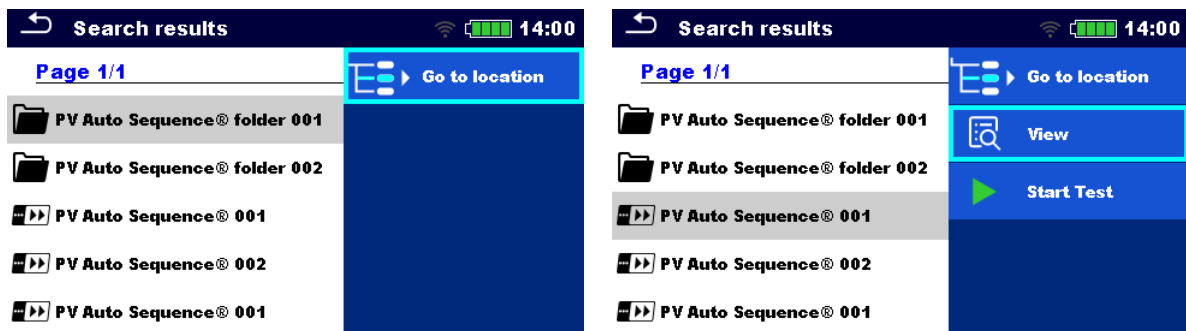

Operations on found Auto Sequences

Page x/y, Next Page, Previous Page	To jump Page Up/Down
Go to location	Go to location in Auto Sequences® menu
Start Test	Start Auto Sequence
View	View Auto Sequence

### 7.1.1 Organization of Auto Sequences® in Auto Sequences® menu

The Auto Sequence® menu can be organized in a structural manner with folders, sub-folders and Auto Sequences. Auto Sequence in the structure can be the original Auto Sequence or a shortcut to the original Auto Sequence.

Originals and shortcuts

Auto Sequences marked as shortcuts and the original Auto Sequences are coupled. Changing of parameters or limits in any of the coupled Auto Sequences will influence on the original Auto Sequence and all its shortcuts.

---

 **PV Auto Sequence® 010** The original Auto Sequence®.

---

 **PV Auto Sequence® 010\_** A shortcut to the original Auto Sequence®.

---

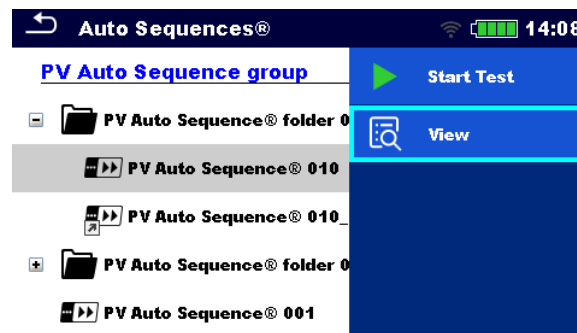

---

Start Test	Start of Auto Sequence
View	Detailed view of Auto Sequence

---

## 7.2 Auto Sequence

Carrying out Auto Sequences step by step

Before starting, the Auto Sequence view menu is shown, (unless it was started directly from the Main Auto Sequences® menu). Before the test, parameters and limits of individual measurements can be edited.

During the execution phase of an Auto Sequence, pre-programmed single tests are carried out. The sequence of single tests is controlled by pre-programmed flow commands.

After the test sequence is finished the Auto Sequence result menu is shown. Details of individual tests can be viewed and the results can be saved to Memory organizer.

---



7.2.1 Auto Sequence® view menu

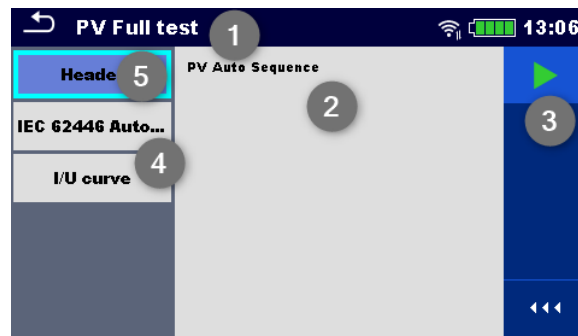

Header is selected

1	Auto Sequence name
2	Description
3	Options
4	Single tests
5	Header

Start Test

Start of Auto Sequence

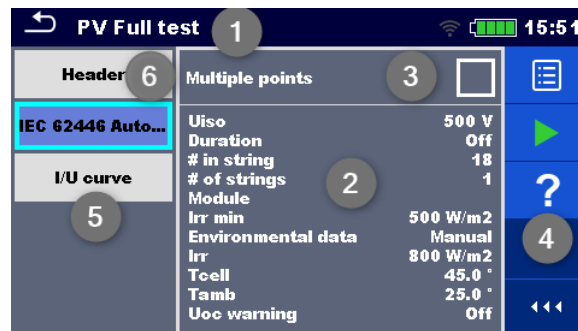

Single test is selected

1	Auto Sequence name
2	Parameters / limits of selected single test
3	Multiple points selected
4	Options
5	Single tests
6	Header

Parameters

View/edit parameters

Start Test

Start of Auto Sequence®

Help

View help screens

Enable multiple points testing: set multiple points, see [Managing multiple points](#).

### 7.2.2 Indication of Loops



The attached 'x3' at the end of single test name indicates that a loop of single tests is programmed. This means that the marked single test will be carried out as many times as the number behind the 'x' indicates. It is possible to exit the loop before, at the end of each individual measurement.

### 7.2.3 Managing multiple points



If the device under test has more than one test point for an individual single test and the selected Auto Sequence predicts only one test point (one single test) it is possible to change the Auto Sequence appropriately. Single tests with enabled Multiple points ticker will be executed in a continuous loop. It is possible to exit the loop anytime at the end of each individual measurement.

The Multiple points setting is valid only for the actual Auto Sequence. If the user often tests appliances with more than one test points it is recommended to program a special Auto Sequence with pre-programmed loops.

#### Hint

Enable multiple points is typically used:

- If testing earthing connections and the DUT has more than one earthed conductive parts.

### 7.2.4 Step by step execution of Auto Sequences

While the Auto Sequence is running, it is controlled by pre-programmed flow commands.

Examples of actions controlled by flow commands

---

Pauses during the Auto Sequence (texts, warnings, pictures)

---

Buzzer Pass / Fail sound after the tests

---

Expert mode for Inspections

---

Skip non-safety notifications

For the actual list and description of flow commands see [Metrel ES Manager Software help file](#).

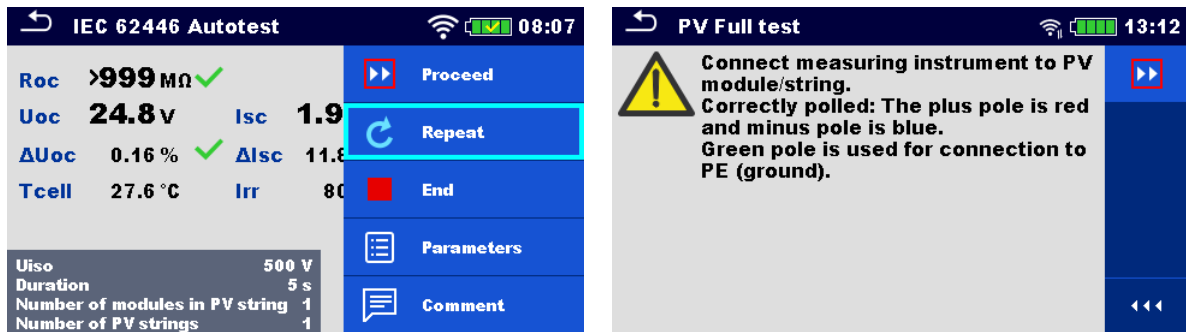

The offered options in the control panel depend on the selected single test, its result and the programmed test flow.

Proceed	Proceeds to the next step in the test sequence.
Repeat	Repeat the measurement.
End loop	Exit the loop of single tests and proceeds to the next step.
End	End the Auto Sequence® and go to result screen.
Parameters	View parameters/limits of single test.
Comment	Add comment

### 7.2.5 Auto Sequence result screen

After the Auto Sequence is finished the result screen is displayed. At the left side of the display the single tests and their statuses in the Auto Sequence are shown. In the middle of the display the header of the Auto Sequence with Short code and description of the Auto Sequence is displayed. At the top the overall Auto Sequence result status is displayed. For more information see [Measurement statuses](#).

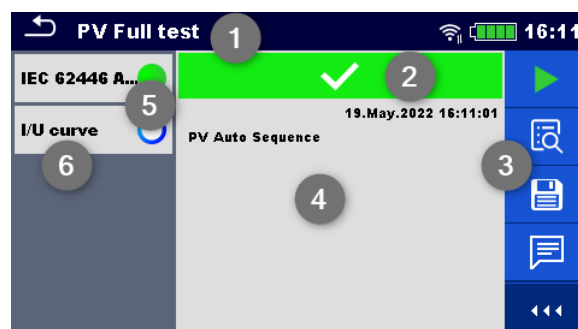

1	Auto Sequence name
2	Overall status
3	Options

4	Description
5	Status of single test
6	Single tests

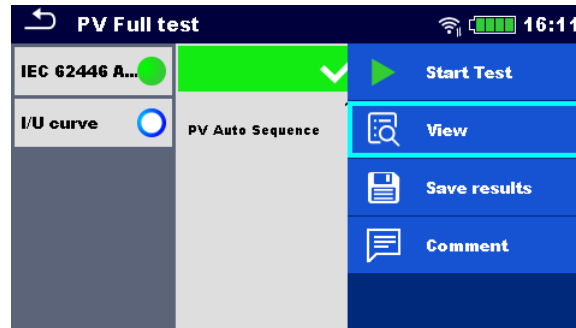

Start Test	Start a new Auto Sequence
View	View results of individual measurements.
Comment	Add comment to Auto Sequence
Tap on Single test	Viewing details of individual single tests, add comment on individual single test
Save results	Save the Auto Sequence results
A new Auto Sequence was selected and started from a Structure object in the structure tree	The Auto Sequence result will be saved under the selected Structure object
A new Auto Sequence was started from the Auto Sequence main menu	Saving under the last selected Structure object will be offered by default. The user can select another Structure object or create a new Structure object. By pressing Save in Memory organizer menu the Auto Sequence result is saved under selected location.
An empty measurement was selected in structure tree and started	The result(s) will be added to the Auto Sequence. The Auto Sequence will change its overall status from <b>'empty'</b> to <b>'finished'</b> .
An already carried out Auto Sequence was selected in structure tree, viewed and then restarted	A new Auto Sequence result will be saved under the selected Structure object.

## 8 Maintenance

### 8.1 Periodic calibration

It is essential that all measuring instruments are regularly calibrated in order for the technical specification listed in this manual to be guaranteed. We recommend an annual calibration.

### 8.2 Service

For repairs under or out of warranty please contact your distributor for further information. Unauthorized person is not allowed to open the instrument. There are no user replaceable parts (including fuses) inside the instrument.

### 8.3 Cleaning

Use a soft, slightly moistened cloth with soap water or alcohol to clean the surface of the instrument. Leave the instrument to dry totally before using it.

#### WARNING

- Do not use liquids based on petrol or hydrocarbons!
- Do not spill cleaning liquid over the instrument!

## 9 Communications

The instrument can communicate with the Metrel ES Manager PC software. The following actions are supported:

- Saved results and Tree structure from Memory organizer can be downloaded and stored to a PC or android device.
- Tree structure from Metrel ES Manager PC software can be uploaded to the instrument.
- PV module list from Metrel ES Manager PC software can be uploaded to the instrument.
- Custom Auto Sequences® can be uploaded to the instrument or downloaded and stored to a PC.

There are three communication interfaces available on the instrument: RS232, USB and Bluetooth.

Instrument can also communicate to A 1785 - PV Remote WL. Only Wi-Fi communication is supported between the instrument and PV Remote WL.

### 9.1 USB and RS232 communication with PC

The instrument automatically selects the communication mode according to detected interface. USB interface has priority.

How to establish an USB or RS-232 link:

- RS-232 communication: connect a PC COM port to the instrument RS232 connector using the RS232 serial communication cable.
- USB communication: connect a PC USB port to the instrument USB connector using the USB interface cable.
- Switch on the PC and the instrument.
- Run the Metrel ES Manager software.
- Select communication port (COM port for USB communication is identified as “Measurement Instrument USB VCom Port”).
- The instrument is prepared to communicate with the PC.

### 9.2 Communication with A 1785 – PV Remote WL

Instrument communicates to A 1785 – PV remote WL using Wi-Fi communication. To establish Wi-Fi communication with PV Remote WL make sure that Wi-Fi communication port is enabled on PV Remote WL. Refer to [A 1785 – PV Remote WL Instruction manual](#) for detailed information.

Before start logging environmental data perform Date & time synchronization between devices as follows:

Place instrument and PV Remote WL close to each other. Switch on both, the instrument and PV Remote WL to synchronize time. Date & time synchronization occurs automatically every time when instrument and PV Remote WL are switched on. If Remote time is ahead of the instrument's time, warning message is displayed.

HINT

- It is recommended to verify Date & time synchronization before start logging environmental data on PV solar field.

# 10 Technical specifications

## 10.1 Test and measurements

### 10.1.1 R ISO PV – Insulation resistance

#### General

Nominal d.c. test voltages  $U_{ISO}$  ..... 250 V, 500 V, 1000 V, 1500 V  
 Open-circuit voltage ..... -0 % / +20 % of nominal voltage  
 Measuring current ..... min 1 mA at nominal resistance  $R = U_{ISO} \times 1 \text{ k}\Omega/\text{V}$   
 Short-circuit current ..... max. 3 mA  
 The number of possible tests ..... > 700, with a new fully charged battery pack at 1500 V / 1.5 M $\Omega$

Auto discharge after test.

Specified accuracy is valid up to 100 M $\Omega$  if relative humidity is over 85 %.

In case the instrument gets moistened, the results could be impaired. In such case, it is recommended to dry the instrument and accessories for at least 24 hours.

The error in operating conditions could be at most the error for reference conditions (specified in the manual for each function)  $\pm 5$  % of measured value.

#### Insulation resistance - $R_{oc+}$ , $R_{oc-}$

Nominal test voltage: 250 V d.c.

Measuring range according to EN 61557: 0.12 M $\Omega$  ... 199.9 M $\Omega$

	Range (M $\Omega$ )	Resolution (M $\Omega$ )	Accuracy
$R_{oc+}$	0.00 ... 19.99	0.01	$\pm(5 \text{ \% of reading} + 3 \text{ digits})$
$R_{oc-}$	20.0 ... 199.9	0.1	$\pm 10 \text{ \% of reading}$

Nominal test voltages: 500 V d.c., 1000 V d.c. and 1500 V d.c.

Measuring range according to EN 61557: 0.12 M $\Omega$  ... 999 M $\Omega$

	Range (M $\Omega$ )	Resolution (M $\Omega$ )	Accuracy
$R_{oc+}$ $R_{oc-}$	0.00 ... 19.99	0.01	$\pm(5 \text{ \% of reading} + 3 \text{ digits})$
	20.0 ... 199.9	0.1	$\pm 5 \text{ \% of reading}$
	200 ... 999	1	$\pm 5 \text{ \% of reading}$

#### Insulation resistance - $R_{oc}$

Nominal test voltages: 250 V d.c.

	Range (M $\Omega$ )	Resolution (M $\Omega$ )	Accuracy
$R_{oc}$	0.00 ... 19.99	0.01	Calculated value
	20.0 ... 199.9	0.1	



Nominal test voltages: 500 V d.c., 1000 V d.c. and 1500 V d.c.

	Range (M $\Omega$ )	Resolution (M $\Omega$ )	Accuracy
Roc	0.00 ... 19.99	0.01	Calculated value
	20.0 ... 199.9	0.1	
	200 ... 999	1	

## Voltage

	Range (V)	Resolution (V)	Accuracy
Um	0.00 ... 1750	1	$\pm(3\% \text{ of reading} + 3 \text{ digits})$

### 10.1.2 R low - 200 mA resistance measurement

#### General

Open-circuit voltage ..... **10 V ... 20 V d.c.**

Measuring current ..... min. 200 mA at resistance  $R = 2 \Omega$

Test lead compensation ..... up to **5  $\Omega$**

The number of possible tests ..... > 800, with a new fully charged battery pack at 200 mA / **0.1  $\Omega$**

Automatic polarity reversal of the test voltage.

#### R low

Measuring range according to EN 61557: 0.12  $\Omega$  ... **1999  $\Omega$**

	Range ( $\Omega$ )	Resolution ( $\Omega$ )	Accuracy
R+	0.00 ... 19.99	0.01	$\pm(3\% \text{ of reading} + 3 \text{ digits})$
R-	20.0 ... 199.9	0.1	$\pm 5\% \text{ of reading}$
R	200 ... 1999	1	$\pm 10\% \text{ of reading}$

### 10.1.3 I/U curve tracking

#### General

System voltage ..... **20 V d.c. ... 1500 V d.c.**

Maximum current ..... 20 A

Maximum power of PV string ..... 24 kW

Connection ..... standard 4 mm METREL safety banana jacks

I-U curve tracking points ..... min. 512 points (time equidistant)

Sampling rate ..... **200 Hz ... 40 kHz**

Accuracy of STC values is based on accuracy of measured electrical quantities, accuracy of environmental parameters, and entered parameters of PV module. See [Appendix D - PV measurements - calculated values](#) for more information about calculation of STC values.

## DC voltage

	Range (V)	Resolution (V)	Accuracy
Uoc_m	20.0 ... 199.9	0.1	±(1 % of reading + 2 digits)
Umpp_m	200 ... <b>1699</b>	1	±1 % of reading

## DC current

	Range (A)	Resolution (A)	Accuracy
Isc_m Impp_m	0.10 ... 0.99	0.01	±6 digits
	1.00 ... 9.99	0.01	±(1 % of reading + 3 digits)
	10.00 ... 19.99	0.01	±1 % of reading

The error in operating conditions could be at most the error for reference conditions ±2 % of measured value.

## DC power

	Range (W)	Resolution (W)	Accuracy
Pmpp_m	0.2 ... 199.9	0.1	±(2 % of reading + 5 digits)
	200 ... 1999	1	±2 % of reading
	2.00 k ... 19.99 k	0.01 k	±2 % of reading
	20.0 k ... <b>29.9 k</b>	0.1 k	±2 % of reading

## 10.1.4 Uoc/Isc measurements

## General

System voltage ..... **20 V d.c. ... 1500 V d.c.**

Maximum current..... 20 A

Maximum power of PV string ..... 24 kW

Connection ..... standard 4 mm METREL safety banana jacks

Accuracy of STC values is based on accuracy of measured electrical quantities, accuracy of environmental parameters, and entered parameters of PV module. See [Appendix D - PV measurements - calculated values](#) for more information about calculation of STC values.

## DC voltage

	Range (V)	Resolution (V)	Accuracy
Uoc_m	20.0 ... 199.9	0.1	±(1 % of reading + 2 digits)
	200 ... 1999	1	±1 % of reading

## DC current

	Range (A)	Resolution (A)	Accuracy
Isc_m	0.10 ... 0.99	0.01	±6 digits
	1.00 ... 9.99	0.01	±(1 % of reading + 3 digits)
	10.00 ... 19.99	0.01	±1 % of reading

The error in operating conditions could be at most the error for reference conditions ±2 % of measured value.

## 10.1.5 Environmental parameters

Environmental parameters are performed in combination with an external remote adapter/instrument.

For technical specification refer to [A 1785 PV Remote WL Instruction manual](#).

## 10.2 General data

## Power supply and charging

Battery power supply .....	Li-Ion, 14.4 V, 4400mAh, non-removable
Battery charging time.....	typical 4.5 h (deep discharge)
Mains power supply.....	100 V ... 240 V, 50 Hz ... 60 Hz, 100 W
Auto-off timer.....	10 min (idle state)

## Protection classifications

Overvoltage category.....	CAT II / 300V
Protection classification.....	Reinforced insulation 
Pollution degree .....	2
Degree of protection.....	IP 54 (cover closed) IP 40 (cover opened)
Altitude.....	up to 4000 m

## Measuring categories

Test sockets .....	no category, no overvoltage
--------------------	-----------------------------

## Display

Display.....	Colour TFT display, 4.3", 480 x 272 pixels
Touch screen .....	Capacitive

## Memory

Memory card slot.....	microSD card, up to 512 GB
-----------------------	----------------------------

## Connectivity

RS232 .....	1 port, DB9 female
USB .....	USB 2.0, standard Type-B
Bluetooth .....	v4.2 BR/EDR and BLE specification
Wi-Fi .....	802.11 b/g/n (802.11n up to 150 Mbps) (Only for communication with A 1785 - PV Remote WL)

## EMC

Emission .....	Class B (Group 1)
Immunity.....	Industrial environment

## Environmental conditions

### Reference conditions

Reference temperature range .....	10 °C ... 30 °C
Reference humidity range .....	40 % ... 70 % RH

### Operation conditions

Operation .....	Outdoor use
Working temperature range .....	0 °C ... +50 °C
Maximum relative humidity .....	85 % RH (0 °C ... 40 °C), non-condensing

### Storage conditions

Temperature range: .....	-10 °C ... +70 °C
Maximum relative humidity: .....	90 % RH (-10 °C ... +40 °C) 80 % RH (40 °C ... 60 °C)

## General

Case .....	Shock proof plastic / portable
Dimensions (w×h×d).....	42 cm × 18 cm × 33 cm
Weight .....	6.8 kg

Accuracies apply for 1 year in reference conditions.

The error in operating conditions could be at most the error for reference conditions (specified in this user manual for each function)  $\pm 1$  % of measured value, unless otherwise specified in this user manual for particular result.

## 11 Appendix A - Remote operation

Different possibilities of remote operation of the instrument are supported.

### 11.1 **Metrel ES Manager**

The Metrel ES Manager is Metrel's SW application for Windows. Among a plenty of features it enables also a complete control over the instrument.

For more information refer to [Metrel ES Manager Software help file](#).

### 11.2 **Black Box protocol**

The Black Box protocol is used for controlling the instrument with Terminal program / application. Communication via: USB and RS232 is possible. The Black Box protocol is a system of rules that allows a PC as a master to start communication by sending the request command to the instrument, which answers according to the protocol.

For more information contact Metrel or distributor.







### 11.3 **SDK**

SDK is a powerful interface for data communication with Metrel test instruments. The SDK itself is a set of subroutine definitions, protocols, and tools for building application software. It is intended for those who want to develop software using .NET platform and need to interface with Metrel instruments. The Metrel Instrument Communication SDK bundles client libraries for accessing Metrel instruments and provides a unified programming interface using C# programming language. The SDK includes a set of API calls which makes communication with Metrel instruments simple for the user.

For more information contact Metrel or distributor.

## 12 Appendix B - Structure objects

Structure elements used in Memory Organizer may be instrument's Profile dependent.

Symbol	Default name	Description
	Node	Node
	Object	Object
	Inverter	PV inverter
	Combiner box	PV Combiner box
	String	PV string
	Module	PV module

## 13 Appendix C - Profile Notes

So far there are no specific profile notes for this instrument.

## 14 Appendix D - PV measurements - calculated values

Calculation to STC

Measured voltage  $U_m$  and current  $I_m$  are calculated to STC as follows:

$$U_{STC} = U_m + U_{OC,m} \left[ \alpha \cdot \log_e \frac{Irr_{STC}}{Irr} + \frac{\beta \cdot (T_{STC} - T_m)}{U_{OC,nom}} \right] - k \cdot R_{s,nom} \cdot (I_{STC} - I_m)$$

$$k = \frac{\text{Number of modules in PV string}}{\text{Number of PV strings}}$$

$$I_{STC} = I_m [1 + \alpha_{rel} \cdot (T_{STC} - T_m)] \cdot \frac{Irr_{STC}}{Irr}$$

Equation symbol	Instrument abbreviation	Description
$I_{STC}$	Isc	Short-circuit current calculated to STC values
$U_{STC}$	Uoc	Open-circuit voltage calculated to STC values
$I_m$	I_m	Measured current
$I_{SC,m}$	Isc_m	Measured short-circuit current
$U_m$	U_m	Measured voltage
$U_{OC,m}$	Uoc_m	Measured open-circuit voltage
$Irr$	Irr	Irradiance at time of measurement
$Irr_{STC}$	-	Irradiance at STC value (1000 W/m <sup>2</sup> )
$T_{STC}$	-	Temperature at STC value (25 °C)
$T_m$	Tcell + Tcell correction	Temperature at time of measurement, including Tcell correction (if applicable)
$\alpha$	-	Irradiance correction factor (typical 0.06)
-	alpha	Temperature coefficient of Isc (A/°C)
$\alpha_{rel}$	alpha/Isc_n	Relative temperature coefficient of Isc (1/°C)
$\beta$	beta	Temperature coefficient of Uoc (V/°C)
$R_{s,nom}$	Rs,nom	Serial resistance of PV module
-	Rs	Serial resistance of string
Number of modules in PV string		Number of PV modules in series
Number of PV strings		Number of PV modules / strings in parallel



$$P_{STC} = I_{mpp,STC} \cdot U_{mpp,STC}$$

Equation symbol	Instrument abbreviation	Description
$U_{mpp,STC}$	U <sub>mpp</sub> (STC)	Maximum power point voltage calculated to STC values
$I_{mpp,STC}$	I <sub>mpp</sub> (STC)	Maximum power point current calculated to STC values
$P_{STC}$	P <sub>mpp</sub> (STC)	Maximum power calculated to STC values

Relative errors are calculated as follows:

$$\Delta P_{mpp} = \left( \frac{P_{STC} - P_{NOM}}{P_{NOM}} \right) \cdot 100\%$$

$$\Delta U_{mpp} = \left( \frac{U_{mpp,STC} - U_{mpp,NOM}}{U_{mpp,NOM}} \right) \cdot 100\%$$

$$\Delta I_{mpp} = \left( \frac{I_{mpp,STC} - I_{mpp,NOM}}{I_{mpp,NOM}} \right) \cdot 100\%$$

$$\Delta U_{oc} = \left( \frac{U_{oc,STC} - U_{oc,NOM}}{U_{oc,NOM}} \right) \cdot 100\%$$

$$\Delta I_{sc} = \left( \frac{I_{sc,STC} - I_{sc,NOM}}{I_{sc,NOM}} \right) \cdot 100\%$$

$$FF_{nom} = \frac{U_{mpp,NOM} \cdot I_{mpp,NOM}}{U_{oc,nom} \cdot I_{sc,nom}} \cdot 100\%$$

$$FF_m = \frac{U_{mpp,m} \cdot I_{mpp,m}}{U_{oc,m} \cdot I_{sc,m}} \cdot 100\%$$

Equation symbol	Instrument abbreviation	Description
$U_{oc,NOM}$	U <sub>oc</sub> (NOM)	Nominal open-circuit voltage
$U_{oc,STC}$	U <sub>oc</sub> (STC)	Open-circuit voltage calculated to STC values
$I_{sc,NOM}$	I <sub>sc</sub> (NOM)	Nominal short-circuit current
$I_{sc,STC}$	I <sub>sc</sub> (STC)	Short-circuit current calculated to STC values
$U_{mpp,NOM}$	U <sub>mpp</sub> (NOM)	Nominal maximum power point voltage

$U_{mpp,STC}$	Umpp (STC)	Maximum power point voltage calculated to STC values
$I_{mpp,NOM}$	Impp (NOM)	Nominal maximum power point current
$I_{mpp,STC}$	Impp (STC)	Maximum power point current calculated to STC values
$P_{STC}$	Pmpp (STC)	Maximum power calculated to STC values
$P_{NOM}$	Pmpp (NOM)	Short-circuit current calculated to STC values
$U_{mpp,m}$	Umpp (Meas)	Measured maximum power point voltage
$I_{mpp,m}$	Impp (Meas)	Measured maximum power point current
$I_{mpp,NOM}$	Impp (NOM)	Nominal maximum power point current
$U_{oc,m}$	Uoc (Meas)	Measured open circuit voltage
$I_{sc,m}$	Isc (Meas)	Measured short circuit current
$\Delta P_{mpp}$	$\Delta P_{mpp}$	Relative error maximum power point
$\Delta U_{mpp}$	$\Delta U_{mpp}$	Relative error of maximum power point voltage
$\Delta I_{mpp}$	$\Delta I_{mpp}$	Relative error of maximum power point current
$\Delta U_{oc}$	$\Delta U_{oc}$	Relative error of open circuit voltage
$\Delta I_{sc}$	$\Delta I_{sc}$	Relative error of short circuit current
$FF_{nom}$	FF (NOM)	Nominal fill factor
$FF_m$	FF (Meas)	Measured fill factor

$\Delta U_{oc}$  relative error warning is calculated as follows

$$\Delta U_{oc} = \left( \frac{U_{oc,STC}}{U_{oc,STC,module} \cdot \text{Number of modules in PV string}} - 1 \right) \cdot 100\%$$

Insulation measurements of PV modules and strings

The first insulation method described in the standard IEC 62446 results in two values:

- Roc+ insulation resistance between positive output and earth
- Roc- insulation resistance between negative output and earth

The second method described in the standard returns only one value:

- Rsc insulation resistance between short circuit outputs and earth

To get comparable results both values of the first method must be converted to a single value result. This can be done using the bellow equation, which is based on the electrical substitute model of PV modules and returns the same or close value to the insulation resistance measured by the second method.

$$R_{oc} = \frac{U_{oc,m}}{U_{ISO}} \cdot \frac{R_{oc+} \cdot R_{oc-}}{R_{oc+} - R_{oc-}}$$

Equation symbol	Instrument abbreviation	Description
$R_{oc+}$	Roc+	Measured resistance between DC+ and PE
$R_{oc-}$	Roc-	Measured resistance between DC+ and PE
$R_{oc}$	Roc	Calculated resistance
$U_{oc,m}$	Uoc_m	Measured PV open-circuit voltage
$U_{ISO}$	Uiso	Measured insulation resistance test voltage

To get accurate results care must be taken, when performing insulation measurements. PV module or string can have a significant capacitive nature therefore the duration of the measurement must be long enough, that the result is stable. Therefore, the user has to set up the duration of the measurement, which can be up to one minute. If the measurement time is too short and the displayed value is not stable the final result must be treated only as informational.

METREL d.o.o.  
Ljubljanska cesta 77  
SI-1354 Horjul  
Slovenia  
Phone: +386 (0)1 75 58 200  
Fax: +386 (0)1 75 49 226  
Email: [info@metrel.si](mailto:info@metrel.si)