

ENGLISH

User's manual



Content:

1. SAFETY PRECAUTIONS AND PROCEDURES	3
1.1. Preliminary.....	3
1.2. During use	4
1.3. After use	4
1.4. Measuring (overvoltage) categories definitions	5
2. GENERAL DESCRIPTION	7
2.1. MEAN VALUE AND TRMS : DEFINITION.....	7
2.2. TRUE ROOT MEAN SQUARE VALUE and CREST FACTOR : definition	7
3. PREPARATION FOR USE	8
3.1. Initial.....	8
3.2. Supply Voltage	8
3.3. Calibration	8
3.4. Storage.....	8
4. OPERATING INSTRUCTIONS.....	9
4.1. Instrument Description.....	9
4.1.1. Front panel.....	9
4.2. FUNCTION Keys	10
4.2.1. MIN MAX	10
4.2.2. PEAK/ Δ	10
4.2.3. RANGE	10
4.2.4. HOLD.....	10
4.2.5. RS-232 for connection to PC (HT39 only).....	11
4.2.6. BACKLIGHT  (HT39 only)	11
4.2.7. Disable AutoPowerOFF	11
4.3. Measurements.....	12
4.3.1. DC voltage measurement	12
4.3.2. AC voltage measurement	13
4.3.3. DC current measurement.....	14
4.3.4. AC current Measurement.....	15
4.3.5. Frequency measurement	16
4.3.6. Resistance measurement	17
4.3.7. Diode test and continuity test.....	18
4.3.8. Capacitance measurement	19
5. MAINTENANCE.....	20
5.1. General Information.....	20
5.2. Battery Replacement	20
5.3. Fuse Replacement	21
5.4. Cleaning	21
6. TECHNICAL SPECIFICATIONS.....	22
6.1. Technical Features	22
6.1.1. Electrical specifications.....	23
6.1.2. Safety.....	23
6.1.3. General data	24
6.2. Environment	24
6.2.1. Environmental conditions.....	24
6.2.2. EMC and LVD.....	24
6.3. Accessories	24
7. SERVICE.....	25
7.1. Warranty Conditions	25
7.2. Service	25

1. SAFETY PRECAUTIONS AND PROCEDURES

This instrument conforms with safety Standard EN 61010-1 related to electronic measuring instruments.

For your own safety and to avoid damaging the instrument follow the procedures described in this instruction manual and read carefully all notes preceded by this symbol



When taking measurements:

- Avoid doing that in humid or wet places
- Avoid doing that in rooms where explosive gas, combustible gas, steam or excessive dust is present.
- Keep you insulated from the object under test.
- Do not touch exposed metal parts such as test lead ends, sockets, fixing objects, circuits etc.
- Avoid doing that if you notice anomalous conditions such as breakages, deformations, fractures, leakages of battery liquid, blind display etc.
- Be particularly careful when measuring voltages exceeding 20V to avoid risks of electrical shocks.

The following symbols are used:



CAUTION - refer to the instruction manual - an improper use may damage the instrument or its components



Danger high voltage: risk of electric shock



Double insulated meter



AC voltage or current



DC voltage or current

1.1. PRELIMINARY

- This instrument has been designed for use in environments of pollution degree 2.
- It can be used for **VOLTAGE** and **CURRENT** measurements on installations of overvoltage category III 1000V and IV 600V.
- This instrument is not suitable for measurements of non sinusoidal voltage and current.
- When using the instrument always respect the usual safety regulations aimed at:
 - ◆ Protecting you against the dangerous electric currents.
 - ◆ Protecting the instrument against incorrect operations.
- Only the leads supplied with the instrument guarantee compliance with the safety standards in force. They must be in good conditions and, if necessary, replaced with identical ones.
- Do not test or connect to any circuit exceeding the specified overload protection.
- Do not effect measurements under environmental conditions exceeding the limits indicated in paragraph 6.2.1.
- Make sure that batteries are properly installed.

- Before connecting the test probes to the installation, make sure that the function selector is positioned on the required measurement.
- Make sure that LCD and function selector indicate the same function.

1.2. DURING USE

Read the recommendations which follow and the instructions in this manual:



CAUTION

An improper use may damage the instrument and/or its components or injure the operator.

- When changing the range, first disconnect the test leads from the circuit under test in order to avoid any accident.
- When the instrument is connected to measuring circuits never touch any unused terminal.
- When measuring resistors do not add any voltage. Although there is a protection circuit, excessive voltage could cause malfunctioning.
- If during measurement the displayed values remain constant check whether the HOLD function is active.

1.3. AFTER USE

- After using the instrument turn it off.
- If you expect not to use the instrument for a long period remove the battery to avoid leakages of battery liquids which may damage its inner components.

1.4. MEASURING (OVERVOLTAGE) CATEGORIES DEFINITIONS

The norm EN 61010-1: Safety requirements for electrical equipment for measurement, control and laboratory use, Part 1: General requirements, defines what measuring category, usually called overvoltage category, is. On paragraph 6.7.4: Measuring circuits, it says:

(OMISSIS)

circuits are divided into the following measurement categories:

- **Measurement category IV** is for measurements performed at the source of the low-voltage installation.
Examples are electricity meters and measurements on primary overcurrent protection devices and ripple control units.
- **Measurement category III** is for measurements performed in the building installation.
Examples are measurements on distribution boards, circuit breakers, wiring, including cables, bus-bars, junction boxes, switches, socket-outlets in the fixed installation, and equipment for industrial use and some other equipment, for example, stationary motors with permanent connection to fixed installation.
- **Measurement category II** is for measurements performed on circuits directly connected to the low voltage installation..
Examples are measurements on household appliances, portable tools and similar equipment..
- **Measurement category I** is for measurements performed on circuits not directly connected to MAINS.
Examples are measurements on circuits not derived from MAINS, and specially protected (internal) MAINS-derived circuits. In the latter case, transient stresses are variable; for that reason, the norm requires that the transient withstand capability of the equipment is made known to the user.

2. GENERAL DESCRIPTION

This instrument performs the following measurements:

- DC (V_{DC}) and AC (V_{AC}) TRMS Voltage
- DC (I_{DC}) and AC (I_{AC}) TRMS Current
- Resistance and Continuity test
- Diode test
- Frequency
- Capacitance

all selectable by means of a 10-position function selector (including OFF position). FUNCTION keys are also available (see chapter 4.2). An analogical bargraph is also available. The selected quantity is displayed with indication of measuring unit and active functions.

The instrument disposes of an Auto Power Off function consisting in an automatic switching off 30 minutes after last pressure on keys or rotation of selector. To resume normal operation turn the selector on OFF and switch it on again.

2.1. MEAN VALUE AND TRMS : DEFINITION

Safety testers for AC quantities are divided in two big families:

- MEAN VALUE instruments, measuring only the value of the wave at the fundamental frequency (50 or 60 Hz)
- TRUE ROOT MEAN SQUARE (or "TRMS") instruments, measuring the true root mean square value of the quantity under test.

In presence of a perfectly sinusoidal wave, both families provide identical results. While in presence of distorted waves, readings are different. Mean value instruments provide only the value of the fundamental wave while TRMS instruments provide the value of the entire wave, including harmonics (within the passband of the instrument). Accordingly, if the same quantity is measured with both kinds of instruments, the measured values are identical only if the wave is purely sinusoidal. Should it be distorted, TRMS instruments provide higher values than MEAN VALUE instruments.

2.2. TRUE ROOT MEAN SQUARE VALUE AND CREST FACTOR : DEFINITION

The effective current value is defined as follows: "In an interval of time equivalent to a period, an alternate current with effective value having an intensity of 1A, by passing on a resistor, disperses the same energy which would be dispersed in the same period of time by a direct current having an intensity of 1A". From this definition comes the numerical

expression: $G = \sqrt{\frac{1}{T} \int_{t_0}^{t_0+T} g^2(t) dt}$ The effective value is indicated as RMS (*root mean square*).

The Crest Factor is defined as the ratio between the Peak Value of a signal and its effective value: $CF (G) = \frac{G_p}{G_{RMS}}$. This value varies according to the waveform of the signal,

for a purely sinusoidal wave it's worth $\sqrt{2} = 1.41$. In presence of distortions the Crest Factor assumes higher values as long as the wave distortion is higher.

3. PREPARATION FOR USE

3.1. INITIAL

This instrument was checked both mechanically and electrically prior to shipment. All possible cares and precautions were taken to let you receive the instrument in perfect conditions. Notwithstanding we suggest you to check it rapidly (eventual damages may have occurred during transport – if so please contact the local distributor from whom you bought the item).

Make sure that all standard accessories mentioned in paragraph 6.3 are included.

Should you have to return back the instrument for any reason please follow the instructions mentioned in paragraph 7.

3.2. SUPPLY VOLTAGE

The instrument is powered by batteries mod. 9V NEDA1604, JIS006P, IEC6F22 included in the packaging. Battery life is approx. 300 hours.

When batteries are low the symbol "⊕" is displayed.

To replace/insert batteries follow the instructions indicated in paragraph 5.2.

3.3. CALIBRATION

The instrument complies with the technical specifications contained in this manual and such compliance is guaranteed for 1 year.

3.4. STORAGE

After a period of storage in extreme environmental conditions exceeding the limits mentioned in paragraph 6.2.1 let the instrument resume normal operating conditions before using it.

4. OPERATING INSTRUCTIONS

4.1. INSTRUMENT DESCRIPTION

4.1.1. Front panel

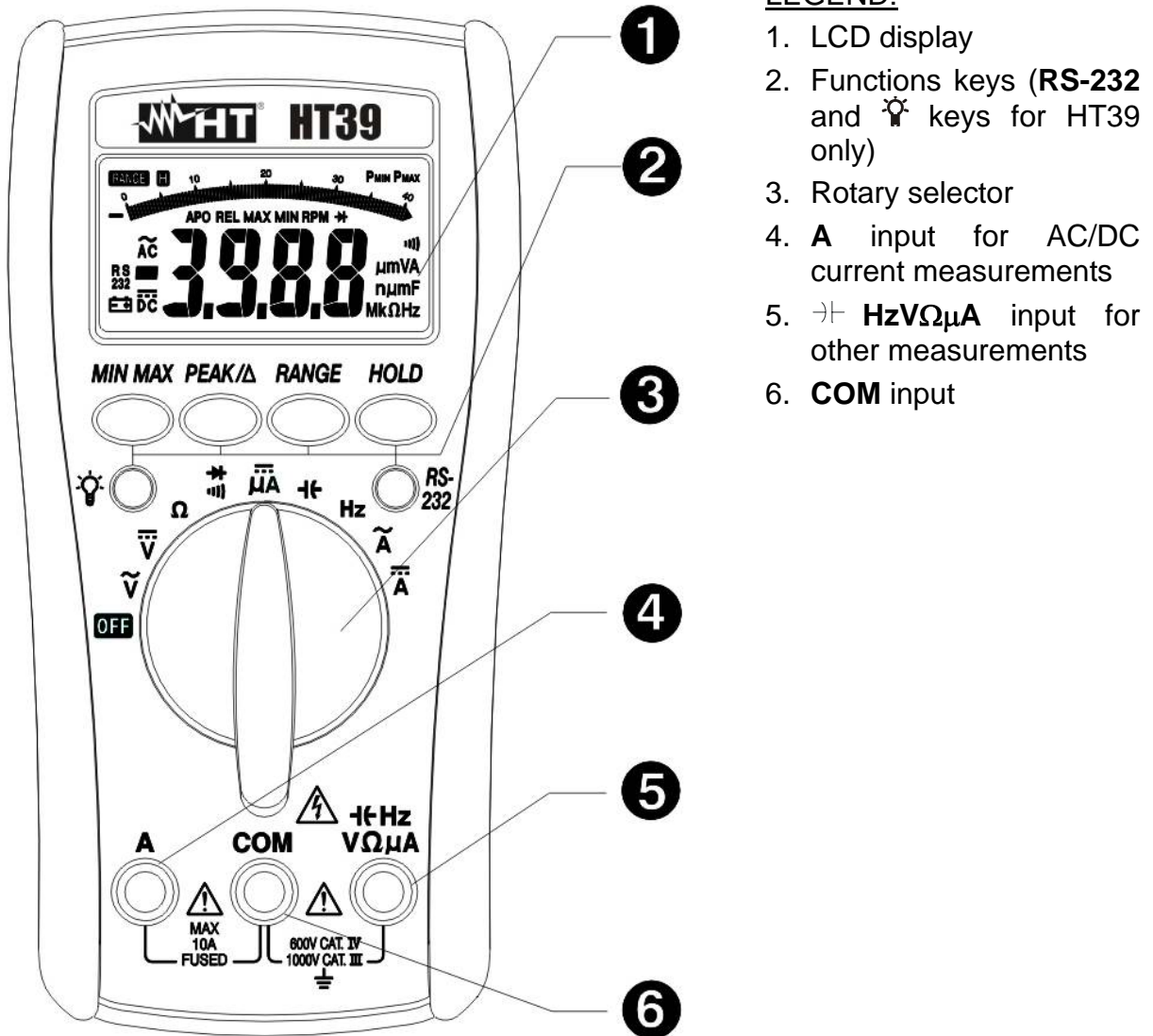

Fig. 1: Instrument description

4.2. FUNCTION KEYS

When pressing a key, the corresponding symbol is displayed with a beep.

To resume default state turn the selector on another function.

4.2.1. MIN MAX

By pressing **MIN MAX** key, maximum and minimum values are measured. Both values are stored and can be recalled by pressing the same key. The symbol corresponding to the desired function is displayed: "MAX" for maximum value, "MIN" for minimum value. **MIN MAX** key is disabled when HOLD function is active. To exit this function keep **MIN MAX** key pressed for at least 1 second or rotate the selector to another position.

4.2.2. PEAK/Δ

This key have the double function of measuring max/min peak values (active for $\sim V$ and $\sim A$ positions of rotary selector) and performing relative measurements (ΔREL) for any position of rotary selector other than $\sim V$ and $\sim A$.

Press cyclically **PEAK/Δ** to measure and save peak values. "P_{MAX}" and "P_{MIN}" symbols on the display correspond to Maximum Peak and Minimum Peak values respectively which are continuously updated by the meter. By keeping pressed **PEAK/Δ** key for at least 3 seconds, "CAL" symbol appears on the display and the meter performs an auto calibration permitting a higher accuracy on peak measurements.

To exit this function keep pressed **PEAK/Δ** for at least one second or rotate the selector on another position.

By pressing **PEAK/Δ** key, the relative measurement is activated: the meter saves the (offset) value on the display and the " ΔREL " symbol is shown. The following measurement will be referred to this offset value. By pressing again **PEAK/Δ** key the offset value is shown and the " ΔREL " symbol is blinking.

To exit this function keep pressed **PEAK/Δ** for at least one second or rotate the selector on another position.

4.2.3. RANGE

By pressing **RANGE** key the manual mode is activated and the "RANGE" symbol is displayed. Press **RANGE** cyclically to change the measuring range and fix the decimal point on the display. **RANGE** is disabled on positions $\blacktriangleright / \cdot))$, $\sim A$ and $\equiv A$ performing measurements in Autorange.

Keeping press for at least 1 second **RANGE** key or moving the rotary switch to exit from this mode.

4.2.4. HOLD

By pressing HOLD the measured value is frozen on the display where the symbol "**HOLD**" appears. To exit this function press **HOLD** again or rotate the selector to another position.

4.2.5. RS-232 for connection to PC (HT39 only)

HT39 can be connected to a PC by means of the optional software package mod. **SW39** (software + serial cable). To connect HT39 to a PC proceed as follows:

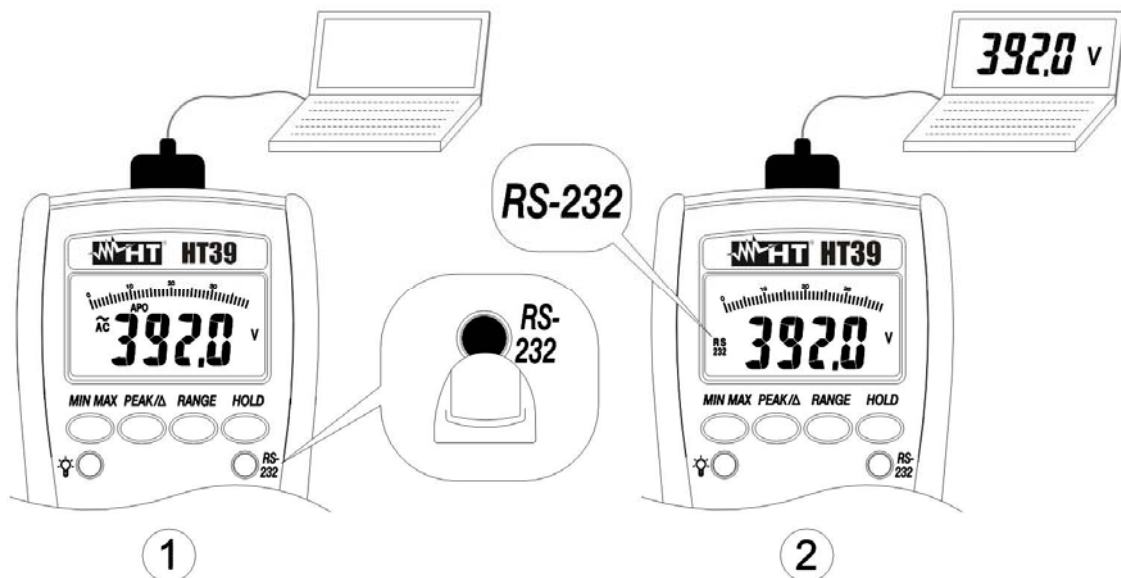



Fig. 2: Connection of HT39 to a PC

1. Insert the connector of the serial cable in the serial input on the upper side of the meter (see Fig. 2).
2. Insert the 9 pin connector plug in the PC serial port (COM).
3. Press **RS-232** key to activate the serial connection. "RS232" symbol is displayed and the "APO" symbol disappears (the AutoPowerOFF function is disabled).
4. Run SW39 software and press "Connect" key to activate the real-time visualization of parameters values between the meter and the PC. **For any detail please refer to the Help-on-line of SW39.**
5. Press **RS-232** key to exit the RS232 mode.

4.2.6. BACKLIGHT (HT39 only)

By pressing  key it's possible to activate/disable the backlight function on the display. This function is available on each position of the rotary selector.

4.2.7. Disable AutoPowerOFF

When the meter is to be used for long periods of time, the operator might want to disable the AutoPowerOFF function. Once the AutoPowerOFF function is disabled the meter stays on continuously. To disable the AutoPowerOFF function:

- switch OFF the meter.
- turn ON the meter keeping pressed **MIN MAX**, **PEAK/Δ** and **RANGE** keys.

The AutoPowerOFF function is automatically activated when turning ON again the meter.

4.3. MEASUREMENTS

4.3.1. DC voltage measurement



CAUTION

Maximum input for DC voltage is 1000V. Do not attempt to take any voltage measurement that exceeds the limits. Exceeding the limits could cause electrical shock and damage the multimeter.

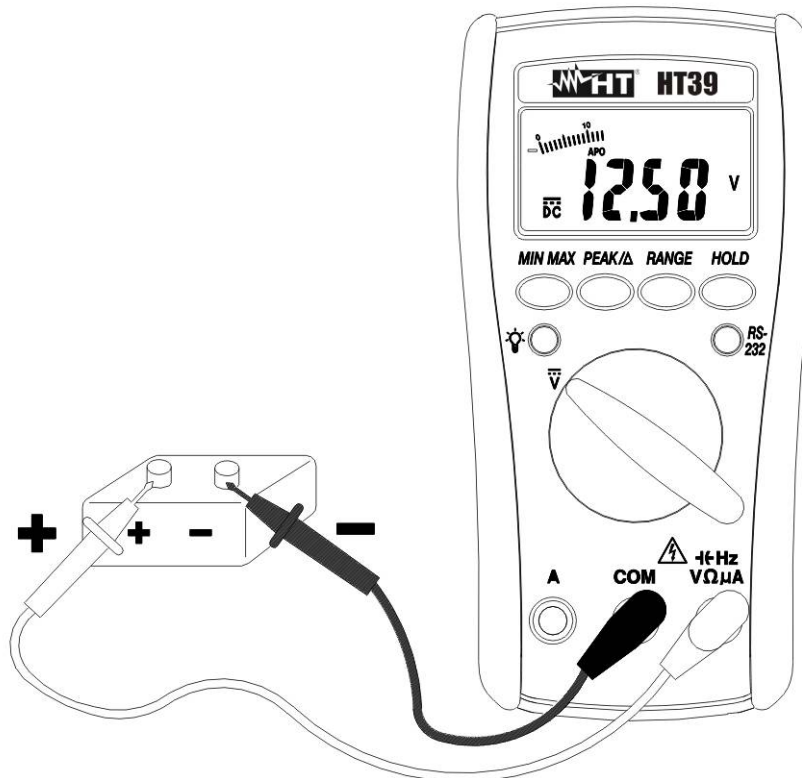

Fig. 3: DC voltage measurement

1. Turn the selector on $\overline{=}$ V.
2. Insert the test leads into the jacks, the red plug into $\overline{+}$ HzV Ω μ A jack and the black plug into **COM** jack (Fig. 3).
3. Connect the red and black test leads to the positive and negative poles of the circuit under test respectively. The voltage value will be displayed with automatic detection of the range.
4. Press **RANGE** key to activate the manual mode; the "AUTO" symbol disappears from display. Press cyclically **RANGE** to change the position of the decimal point on the display. To activate the Autorange function keep pressed **RANGE** for at least 1 second.
5. The message "OL" means that the voltage exceeds the measuring limits. In this case disconnect the test leads from the circuit under test to avoid damaging the instrument or endanger your own safety.
6. The symbol "-" on the display means that voltage has opposite direction than shown in Fig. 3.
7. For minimum and maximum value measurement, HOLD and Relative Δ REL functions please refer to paragraph 4.2.

4.3.2. AC voltage measurement

CAUTION



Maximum input for AC voltage is 1000V rms. Do not attempt to take any voltage measurement exceeding such limit to avoid the risk of electrical shock and damages to the instrument.

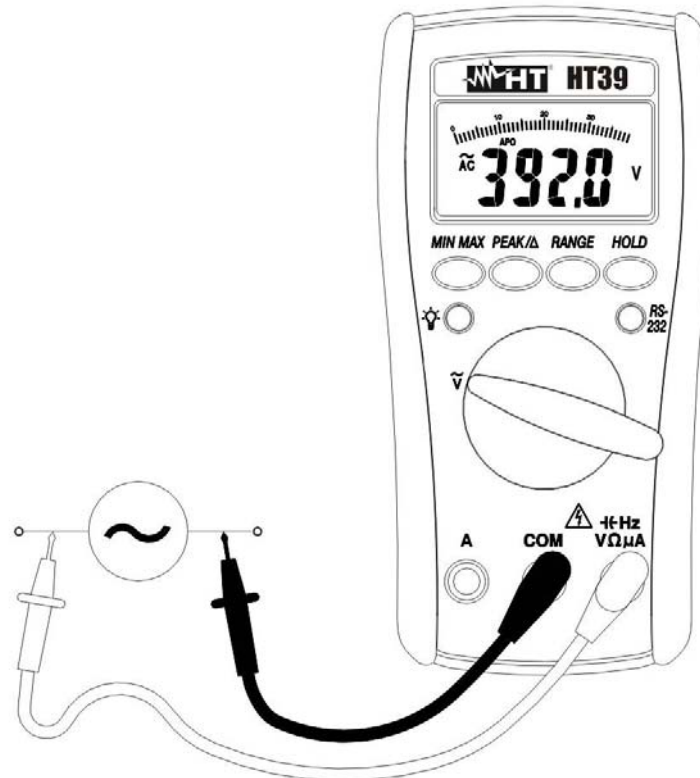

Fig. 4: AC voltage measurement

1. Turn the selector on $\sim V$.
2. Insert the test leads into the jacks, the red plug into $\rightarrow HzV\Omega\mu A$ jack and the black plug into **COM** jack (Fig. 4).
3. Connect the red and black test leads to the positive and negative poles of the circuit under test respectively. The voltage value will be displayed with automatic detection of the range.
4. Press **RANGE** key to activate the manual mode; the "AUTO" symbol disappears from display. Press cyclically **RANGE** to change the position of the decimal point on the display. To activate the Autorange function keep pressed **RANGE** for at least 1 second.
5. The message "**OL**" means that the voltage exceeds the measuring limits. In this case disconnect the test leads from the circuit under test to avoid damaging the instrument or endanger your own safety.
6. For minimum and maximum value measurement, HOLD function and Peak measurement please refer to paragraph 4.2.

4.3.3. DC current measurement

CAUTION



Maximum input for DC current is 10A. Do not attempt to take any current measurement exceeding such limit to avoid the risk of electrical shock and damages to the instrument.

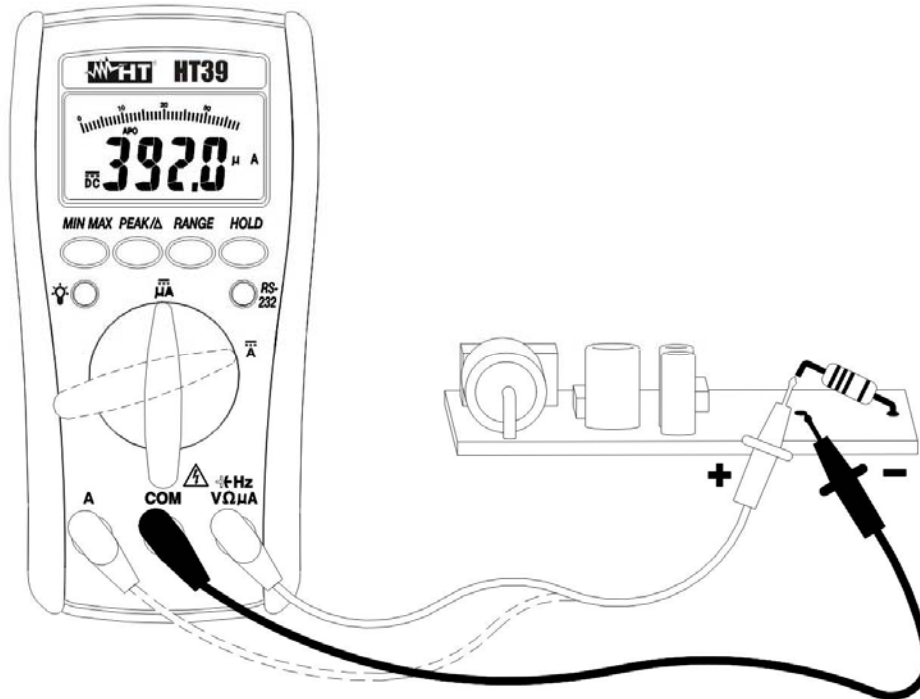

Fig. 5: DC current measurement

1. Switch OFF the circuit under test.
2. Turn the selector on $\overline{=}$ A.
3. Insert the red test lead into **A** jack and the black plug into **COM** jack (Fig. 5).
4. Connect red and black plugs in series with the circuit under test respecting the polarity and current flow indicated in Fig. 5.
5. Power the circuit under test. The current value is displayed.
6. The message "**OL**" means that the voltage exceeds the measuring limits. In this case disconnect the test leads from the circuit under test to avoid damaging the instrument or endanger your own safety.
7. If the measured value is lower than **4mA**, to get a better resolution:
 - Switch off the circuit under test.
 - Turn the selector on $\overline{=}$ μ A.
 - Remove the red test lead from **A** jack, and insert it into \rightarrow HzV Ω μ A jack.
 - Power the circuit under test.
8. The symbol "-" on the display means that current has opposite direction than shown in Fig. 5. Press **RANGE** key for manual range only active in $\overline{=}$ μ A position of the rotary selector.
9. For minimum and maximum value measurement, HOLD and Relative Δ REL functions please refer to paragraph 4.2.

4.3.4. AC current Measurement



CAUTION

Maximum input for AC current is 10A. Do not attempt to take any current measurement exceeding such limit to avoid the risk of electrical shock and damages to the instrument.

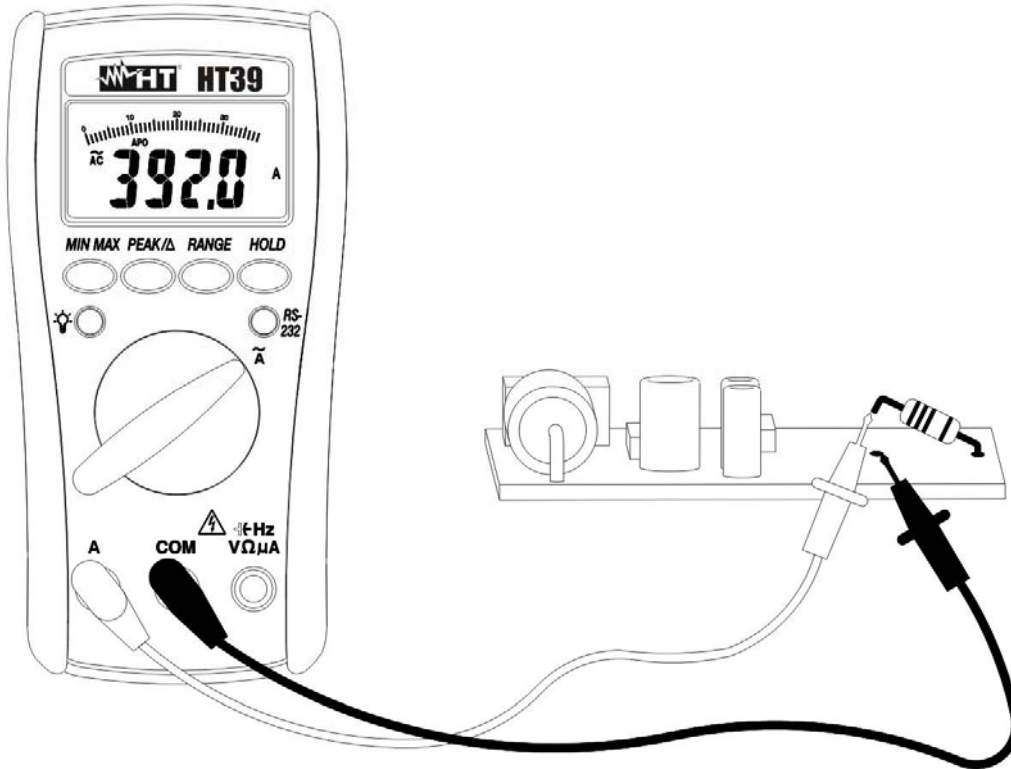

Fig. 6: AC current measurement

1. Switch OFF the circuit under test.
2. Turn the selector on $\sim A$.
3. Insert the test leads into the jacks, the red plug into **A** jack and the black plug into **COM** jack (Fig. 6).
4. Connect red and black plugs in series with the circuit under test as indicated in Fig. 5
5. Power the circuit under test. The current value is displayed.
6. The message "**OL**" means that the voltage exceeds the measuring limits. In this case disconnect the test leads from the circuit under test to avoid damaging the instrument or endanger your own safety.
7. For minimum and maximum value measurement, HOLD function and Peak measurement please refer to paragraph 4.2.

4.3.5. Frequency measurement

CAUTION



Maximum input for AC voltage is 750V rms. Do not attempt to take any voltage measurement exceeding such limit to avoid the risk of electrical shock and damages to the instrument.

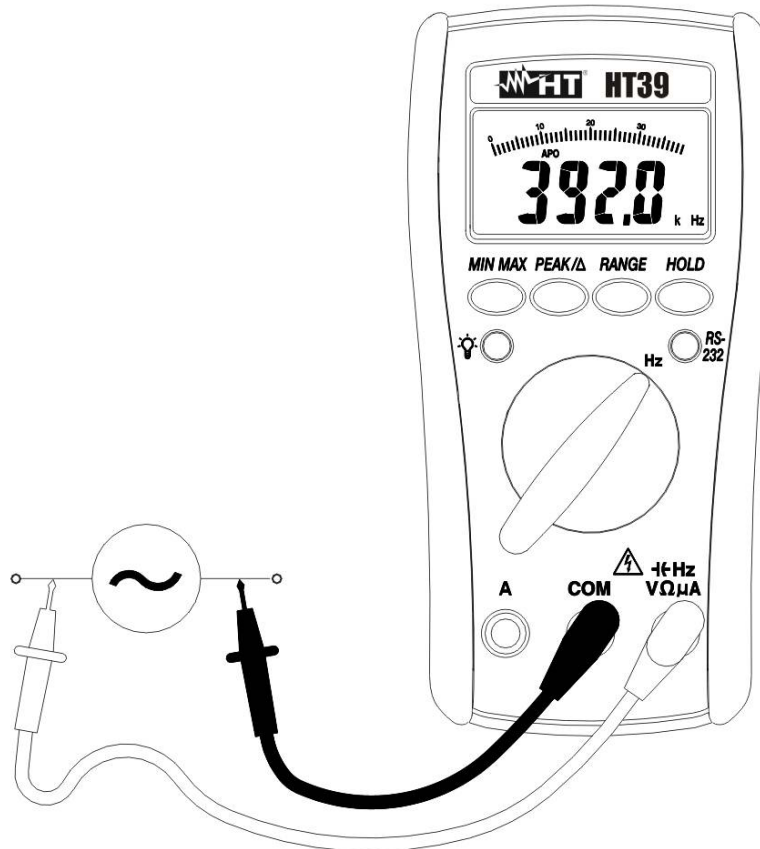

Fig. 7: Frequency measurement

1. Turn the selector on **Hz**.
2. Insert the test leads into the jacks, the red plug into \rightarrow **HzVΩμA** jack and the black plug into **COM** jack (Fig. 7).
3. Connect the red and black test leads to the positive and negative poles of the circuit under test respectively. The voltage value will be displayed with automatic detection of the range.
4. Press **RANGE** key to activate the manual mode; the "AUTO" symbol disappears from display. Press cyclically **RANGE** to change the position of the decimal point on the display. To activate the Autorange function keep pressed **RANGE** for at least 1 second.
5. The message "**OL**" means that the voltage exceeds the measuring limits. In this case disconnect the test leads from the circuit under test to avoid damaging the instrument or endanger your own safety.
6. For minimum and maximum value measurement, HOLD and Relative Δ REL functions please refer to paragraph 4.2.

4.3.6. Resistance measurement



CAUTION

Before taking resistance measurements in circuit remove power from the circuit being tested and discharge all capacitors.

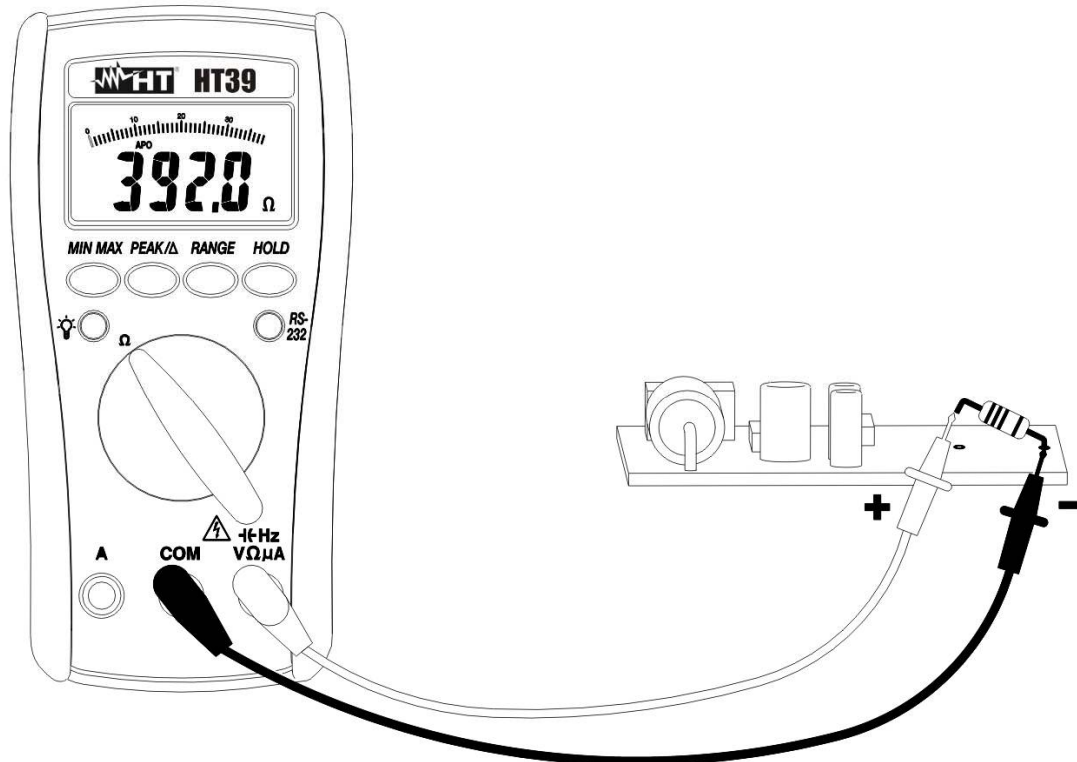

Fig. 8: Resistance measurement

1. Turn the selector on Ω .
2. Insert the test leads into the jacks, the red plug into $\rightarrow \text{HzV}\Omega\mu\text{A}$ jack and the black plug into **COM** jack (Fig. 8).
3. Connect the red and black test leads to the circuit under test, the resistance value will be displayed with automatic detection of the range.
4. Press **RANGE** key to activate the manual mode; the "AUTO" symbol disappears from display. Press cyclically **RANGE** to change the position of the decimal point on the display. To activate the Autorange function keep pressed **RANGE** for at least 1 second.
5. The message "OL" means that the voltage exceeds the measuring limits. In this case disconnect the test leads from the circuit under test to avoid damaging the instrument or endanger your own safety.
6. For minimum and maximum value measurement, HOLD and Relative ΔREL functions please refer to paragraph 4.2.

4.3.7. Diode test and continuity test



CAUTION

Before taking resistance measurements in circuit remove power from the circuit being tested and discharge all capacitors.

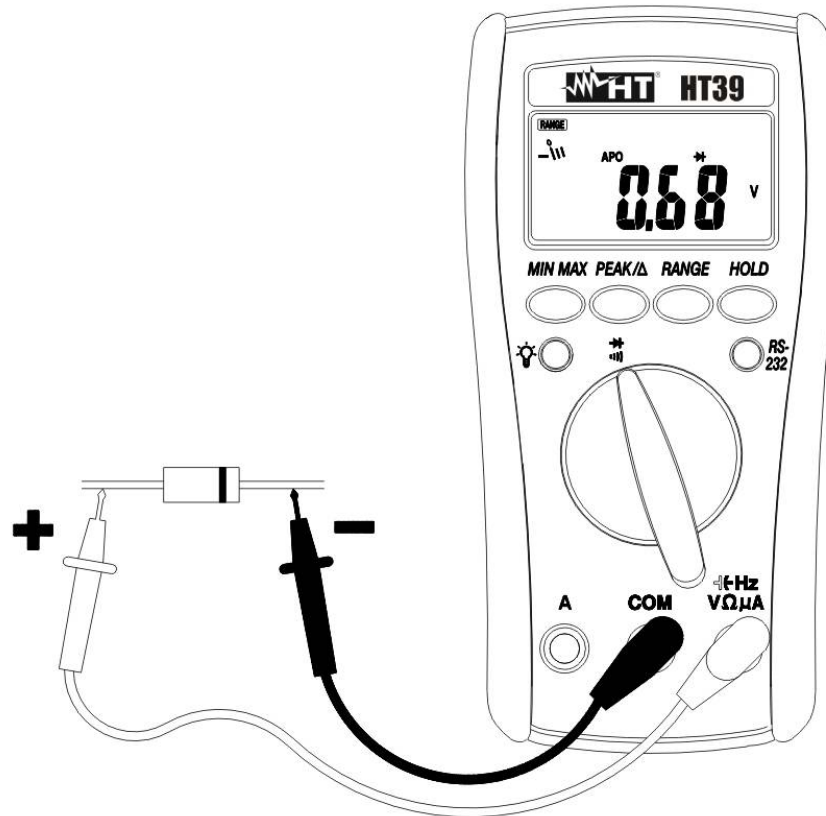

Fig. 9: Diode test

1. Turn the selector on \rightarrow (diode symbol).
2. Insert the test leads into the jacks, the red plug into \rightarrow HzVΩμA jack and the black plug into **COM** jack (Fig. 9).
3. Connect the red lead to the positive side (anode) of the diode and the black lead to the negative side (cathode). The meter displays the diode voltage to approximately 0.4 ~ 0.9V for good junction.
4. Reverse the connections and measure the voltage across the diode again. The message "**OL**" on the display corresponds to a correct junction.
5. The continuity test is always active and the test is performed using the test leads in the same way of resistance measurement (refer to paragraph 4.3.6). The buzzer is on for resistance values $<500\Omega$.
6. For minimum and maximum value measurement, HOLD and Relative Δ REL functions please refer to paragraph 4.2.

4.3.8. Capacitance measurement

CAUTION



Before taking any in circuit or capacitance measurement, remove power from the circuit being tested and discharge all capacitors. Use the short test lead pair for measurement in order to reduce the stray capacitance. Before connecting the test capacitor, note the display, which may show a reading other than zero whenever the range is changed. Subtract this offset reading from the test result of a capacitor to obtain the true value. Connect the test capacitor to the input clamps noting the polarity connections when required.

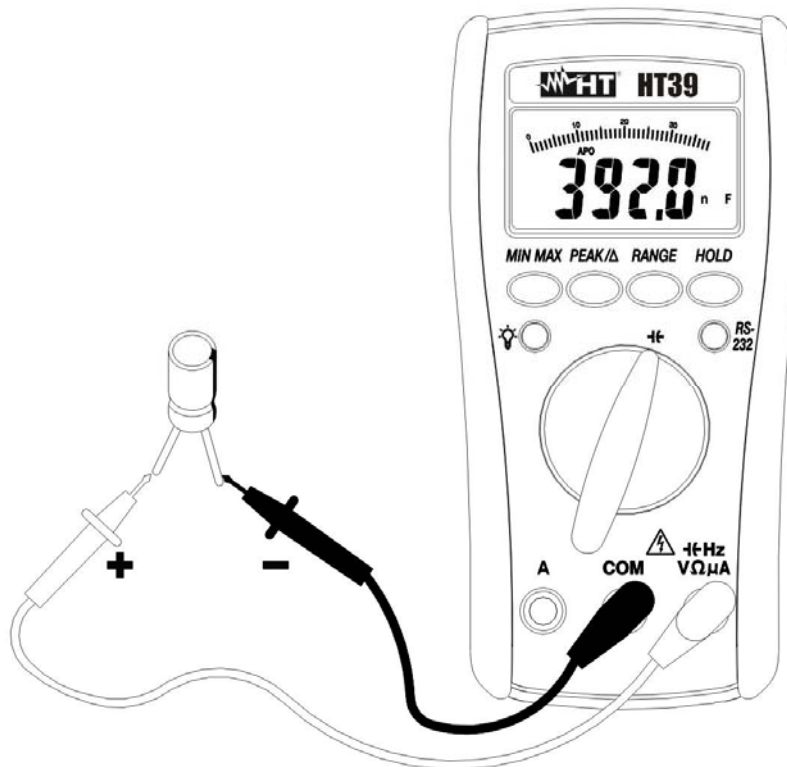

Fig. 10: Capacitance measurement

1. Turn the selector on \rightarrow .
2. Insert the test leads into the jacks, the red plug into \rightarrow HzVΩμA jack and the black plug into **COM** jack (Fig. 10).
3. Connect the test leads to the capacitor terminals taking care of the shown polarity. The capacitance value will be displayed with automatic detection of the range.
4. Press **RANGE** key to activate the manual mode; the "AUTO" symbol disappears from display. Press cyclically **RANGE** to change the position of the decimal point on the display. To activate the Autorange function keep pressed **RANGE** for at least 1 second.
5. The message "OL" means that the voltage exceeds the measuring limits. In this case disconnect the test leads from the circuit under test to avoid damaging the instrument or endanger your own safety.
6. For minimum and maximum value measurement, HOLD and Relative ΔREL functions please refer to paragraph 4.2.

5. MAINTENANCE

5.1. GENERAL INFORMATION

This is a precision instrument. To guarantee its performances be sure to use it according to these instructions and keep it stored on suitable environmental conditions Do not expose it to high temperatures or humidity or direct sunlight. Be sure to turn it off after use. If you expect not to use the instrument for a long period remove batteries to avoid leakages of battery liquid which could damage the its inner components.

5.2. BATTERY REPLACEMENT

When the symbol "⊕" is displayed, batteries need replacement.

CAUTION



Before replacing batteries disconnect the test leads from any energized circuits to avoid electrical shocks.

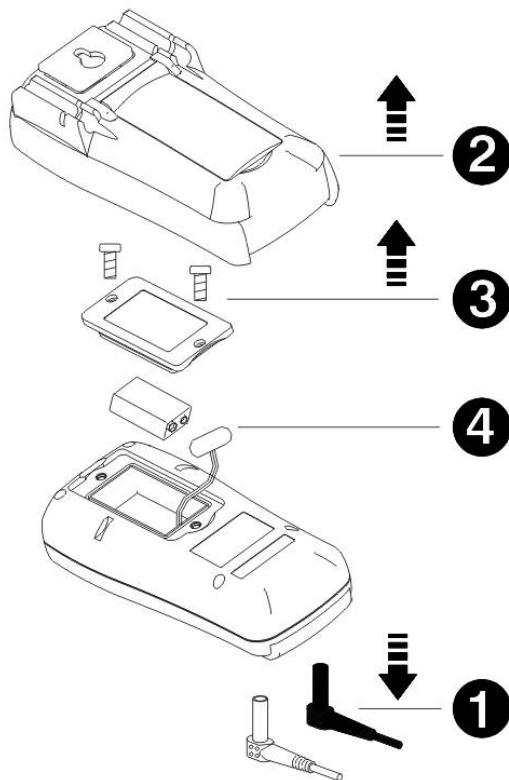

LEGEND:

1. Turn OFF the meter and disconnect the test leads from the input terminals.
2. Remove the protective holster from the meter.
3. Unscrew the battery cover and remove the battery.
4. Insert a new battery of the same type (9V NEDA1604, JIS006P, IEC6F22) observing the proper polarity, re-screw the battery cover and reposition the protective holster.

Fig. 11: Battery replacement

5.3. FUSE REPLACEMENT



CAUTION

Before replacing fuses, disconnect test leads from any energized circuit to avoid electrical shock.

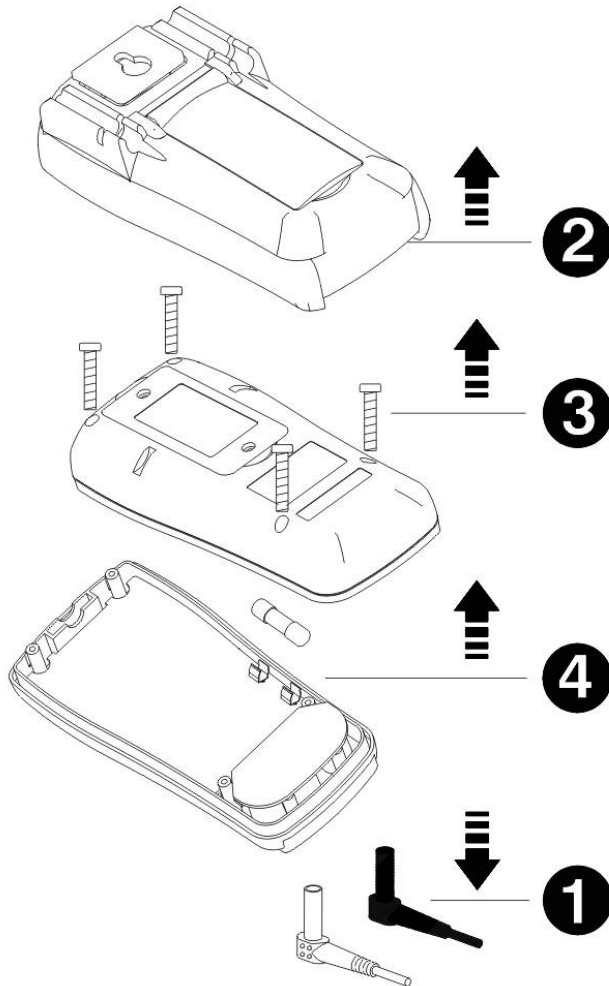

LEGEND:

1. Turn OFF the meter and disconnect the test leads from the input terminals.
2. Remove the protective holster from the meter.
3. Unscrew the battery cover and remove the battery.
4. Remove the defective fuse and install a new fuse of the same size and rating (fast type 10A/1000V). Make sure the new fuse is centered in the fuse holder. Re-screw the battery cover and reposition the protective holster.

Fig. 12: Fuse replacement

5.4. CLEANING

To clean the instrument use a soft dry cloth. Never use a wet cloth, solvents or water.

6. TECHNICAL SPECIFICATIONS

6.1. TECHNICAL FEATURES

The accuracy is indicated as [% of reading + number of digits]. It is referred to the following environmental conditions: temperature $23^{\circ}\text{C} \pm 5^{\circ}\text{C}$, relative humidity < 80%.

• DC voltage

Range	Resolution	Accuracy	Input impedance	Overload protection
400.0mV	0.1mV	$\pm(0.5\%rdg+2dgt)$	10M Ω // less of 100pF	1000VDC 750VACrms
4.000V	0.001V			
40.00V	0.01V			
400.0V	0.1V			
1000V	1V			

• AC TRMS voltage

Range	Resolution	Accuracy (50 ÷ 500Hz)	Input impedance	Overload protection
400.0mV	0.1mV	Not specified	10M Ω // less of 100pF	1000VDC 750VACrms
4.000V	0.001V	$\pm(1.3\%rdg+5dgt)$ (50 ÷ 300Hz)		
40.00V	0.01V	$\pm(1.2\%rdg+5dgt)$ (50 ÷ 500Hz)		
400.0V	0.1V			
750V	1V			

• DC current

Range	Resolution	Accuracy	Output voltage	Overload protection
400.0 μ A	0.1 μ A	$\pm(1.0\%rdg+2dgt)$	<5mV/ μ A	600Vrms
4000 μ A	1 μ A		2V max	Fast fuse 10A / 1000V
10.00A	10mA			

• AC TRMS current (Autorange)

Range	Resolution	Accuracy (50 ÷ 500Hz)	Output voltage	Overload protection
10A	10mA	$\pm(1.5\%rdg+5dgt)$	2V max	600Vrms

• Frequency

Range	Resolution	Accuracy	Sensitivity	Overload protection
4000Hz	1Hz	$\pm(0.01\%rdg+1dgt)$	>1.5VACrms <5VACrms	600Vrms
40.00kHz	0.01kHz			
400.0kHz	0.1kHz		>2VACrms <5VACrms	
4.000MHz	0.001MHz			
40.00MHz	0.01MHz			

Minimum pulse width: 25ns
Duty cycle limit: >30% e <70%

• Resistance

Range	Resolution	Accuracy	Open voltage	Overload protection
400.0Ω	0.1Ω	±(1.0%rdg+5dgt)	1.3V	600V rms
4.000kΩ	0.001kΩ	±(0.7%rdg+2dgt)		
40.00kΩ	0.01kΩ			
400.0kΩ	0.1kΩ			
4.000MΩ	0.001MΩ	±(1.0%rdg+2dgt)		
40.00MΩ	0.01MΩ	±(1.5%rdg+5dgt)		

• Diode test

Range	Resolution	Accuracy (0.4 ÷ 0.8V)	Test current	Open voltage	Overload protection
	10mV	±(1.5%rdg+5dgt)	1.5mA	<3V	600V rms

• Continuity test

Range	Buzzer	Overload protection
	R<450Ω	600V rms

• Capacitance

Range	Resolution	Accuracy	Overload protection
4.000nF	0.001nF	±(3.0%rdg+10dgt)	600V rms
40.00nF	0.01nF	±(2.0%rdg+8gt)	
400.0nF	0.1nF		
4.000μF	0.001μF		
40.00μF	0.01μF		
400.0μF	0.1μF		
4.000mF	0.001mF	±(5.0%rdg+20dgt)	
40.00mF	0.01mF		

6.1.1. Electrical specifications

Conversion:	TRMS
Measuring rate:	1.5 times per second
Temperature coefficient:	0.15×(accuracy)/°C (<18°C and >28°C)
NMRR Normal Mode Rejection Ratio:	> 50dB for DC parameters and 50/60Hz
CMRR Common Mode Rejection Ratio:	>100dB from DC up to 60Hz on DCV > 60dB from DC up to 60Hz on ACV

6.1.2. Safety

The instrument complies with:	EN 61010-1
Insulation:	class 2, double insulation
Pollution degree:	2
Overvoltage category:	CAT IV 600V, CAT III 1000V (V/Ω/μA) CAT IV 500V (A)
For indoor use, max height:	2000m

6.1.3. General data

Mechanical characteristics

Dimensions (with holster): 164x82x44mm
Weight (including battery): about 400g

Power supply

Battery type: 9V NEDA1604, JIS006P, IEC6F22
Low battery indication: "⊕⊖" is displayed when battery voltage is too low.
Battery life: about 300 hours
AutoPowerOFF: 30 minutes after last pressure on keys or rotation of selector

Display

Specifications: 4 LCD with max. reading 4000 counts + symbol, decimal point and bargraph
Over range indication: "OL" or "-OL"

6.2. ENVIRONMENT

6.2.1. Environmental conditions

Reference temperature: $23^{\circ} \pm 5^{\circ}\text{C}$
Working temperature: $0 \div 30^{\circ}\text{C}$
Relative humidity: <80%
Storage temperature: $-20 \div 60^{\circ}\text{C}$
Storage humidity: <80%

6.2.2. EMC and LVD

This tester was designed in accordance with EMC standards in force and its compatibility has been tested in accordance with EN61326-1 (1997) + A1 (1998) + A2 (2001).

This product conforms to the prescriptions of the European directive on low voltage 73/23/EEC and to EMC directive 89/336/EEC, amended by 93/68/EEC.

6.3. ACCESSORIES

Standard accessories

- Test leads
- Battery (fitted)
- Instruction manual
- Warranty card

Optional accessories

- Carrying bag mod. B80
- (only for HT39) software + serial cable mod. SW39

7. SERVICE

7.1. WARRANTY CONDITIONS

This instrument is guaranteed for one year against material or production defects, in accordance with our general sales conditions. During the warranty period the manufacturer reserves the right to decide either to repair or replace the product.

Should you need for any reason to return back the instrument for repair or replacement take prior agreements with the local distributor from whom you bought it. Do not forget to enclose a report describing the reasons for returning (detected fault). Use only original packaging. Any damage occurred in transit due to non original packaging will be charged anyhow to the customer.

The warranty doesn't apply to:

- Accessories and batteries (not covered by warranty).
- Repairs made necessary by improper use (including adaptation to particular applications not foreseen in the instructions manual) or improper combination with incompatible accessories or equipment.
- Repairs made necessary by improper shipping material causing damages in transit.
- Repairs made necessary by previous attempts for repair carried out by non skilled or unauthorized personnel.
- Instruments for whatever reason modified by the customer himself without explicit authorization of our Technical Dept.

The contents of this manual may not be reproduced in any form whatsoever without the manufacturer's authorization.

Our products are patented and our logotypes registered. We reserve the right to modify specifications and prices in view of technological improvements or developments which might be necessary.

7.2. SERVICE

Shouldn't the instrument work properly, before contacting your distributor make sure that batteries are correctly installed and working, check the test leads and replace them if necessary.

Should you need for any reason to return back the instrument for repair or replacement take prior agreements with the local distributor from whom you bought it. Do not forget to enclose a report describing the reasons for returning (detected fault). Use only original packaging. Any damage occurred in transit due to non original packaging will be charged anyhow to the customer.

The manufacturer will not be responsible for any damage to persons or things.