

7849B – 7859B – 7817B

Sefram



7849B TER/SAT

7859B TER/SAT/OPTICAL

7817B CABLE

FIELD STRENGTH METER

USER MANUAL

This product contains one or more programs protected under international and US copyright laws as unpublished works. They are confidential and proprietary to Dolby laboratories. Their reproduction or disclosure, in whole or in part, or the production of derivative works there from without the express permission of Dolby Laboratories is prohibited. Copyright 2003-2005 by Dolby Laboratories. All rights reserved.

Thank you for purchasing this SEFRAM product and therefore trusting our company. Our different teams (research department, production, sales department, after-sales service...) are aiming at satisfying your wishes by designing and updating very advanced appliances.

To obtain the best performance from this product please read this manual carefully.

For more information please contact our different services

04 77 59 01 01

E-mail Sales department: sales@sefram.com

E-mail After-sales: sav@sefram.com

E-mail Technical support: support@sefram.com

Fax: +33 (0)4 77 57 23 23

Web: www.sefram.com



Copyright Sefram, 2020. All rights reserved.

Any total or partial reproduction of this document must be submitted for Sefram written authorisation.

GUARANTEE

Your instrument is guaranteed for one year for labor and parts against any manufacturing defect and/or functioning hazard. This guarantee extends from the delivery date and ends 365 calendar days later.

In case of guarantee contract, this will cancel or replace these guarantee conditions here above.

The guarantee conditions by SEFRAM are available on the website www.sefram.com. The general guarantee conditions should prevail on the following conditions that they sum up.

This guarantee does not cover the result of any abnormal use, handling mistake or mistake in the storage conditions outside the defined range.

In case of application of the guarantee, the user shall return, at its own expenses, the relevant appliance to our factory:

SEFRAM Instruments & Systèmes
Service Après-vente
32, Rue Edouard MARTEL
BP 55
42009 SAINT-ETIENNE CEDEX 2

And add a description of the observed breakdown to the appliance.

The standard supplies provided with the appliance (cables, outlets...), the consumables (batteries ...) and the optional supplies (suitcases...) are guaranteed for 3 months against any manufacturing defect.

Such items as a suitcase, a LCD screen or a touchpad are guaranteed only for a normal use.

The guarantee does not cover wearing, accidental breaks or consecutive to a shock or any abnormal use.

The factory options integrated to the appliance are guaranteed for the same duration as the appliance itself.

In case of replacement or repair of the product, the remaining guarantee duration shall be:

- The remaining duration of the guarantee if the appliance is still under guarantee
- If the guarantee duration is less than 90 days, the replaced part is guaranteed for 90 days

Any replacement part becomes the property of the user and the exchanged parts become the property of SEFRAM.

In case of intervention by an insurance company, the product becomes the property of the insurance company upon its exclusive request. Else, it shall remain property of the user.

The guarantee covers exclusively the materials manufactured and provided by SEFRAM.

Any intervention by the user or any third party without prior authorization by the company voids the guarantee.

The user shall be responsible for the return of its appliance to our site. Hence, it shall provide for a conditioning that shall correctly protect the appliance while shipping. It shall subscribe, at its own expenses, any insurance required for the transport.

The SEFRAM company reserves the right to refuse any product wrongly conditioned and not to take in charge any break consecutive to the transport.

Particular case of the battery: There is a Li-ion battery as a standard equipment of this appliance. It shall not be transported outside the appliance. In no case shall the user replace it. Its replacement in the factory is necessary to check the charge system and the protective securities.

What to do in case of malfunction?

In case of malfunction or for any advice for use, please contact the technical support by SEFRAM Instruments & Systèmes: 04 77 59 01 01

A technician shall answer you and give you any information required to solve your problem.

What to do in case of failure?

In case of failure of your appliance, please contact the technical support: 04 77 59 01 01

Some advice!

Some technical help!

SEFRAM Instruments & Systèmes commits itself to help you on the phone about the use of your appliance.

Please call or Technical Support:

04 77 59 01 01

Or e-mail:

support@sefram.com

We thank you for your trust.

METROLOGY

The meteorological conditions of your measurement instrument are defined in the specifications of this notice. Climate and environmental conditions restrict the specifications of your Field Strength Measurer (MDC). SEFRAM checks the characteristics of each appliance one by one on an automatic bench during its manufacture. The adjustment and control are guaranteed under conditions of the ISO9001 certification by facilities in connection with the COFRAC (or equivalent in the context of ILAC reciprocity).

The specified characteristics are considered stable for a period of 12 months from the first use under normal conditions of use.

We recommend a check after 12 months and max. 24 months of use, then every 12 months after 24 months.

For any check of the characteristics, the following average climate conditions shall be maintained ($23^{\circ}\text{C} \pm 3^{\circ}\text{C} - 50(\pm 20)\% \text{RH}$).

The MDC should have been working for 0,5 hour before check.

We recommend that you have this control made by our after-sales service (Service Après-Vente) for the best service and preservation of the measuring quality of your instrument.

When a MDC returns to SEFRAM, maximum service is provided with internal updating according to the required adjustments and software updates. In case of shift in the characteristics, your instrument shall be adjusted to recover its original characteristics.

PACKAGING

The packaging of this product is fully recyclable. Its design allows the transport of your instrument under the best possible conditions. Please note that the original packaging should be additionally wrapped in case of transport by air, road or postal.

SPARE PARTS

According to the consumption law of March 17, 2014, Article L111-3 and Decree 2014-1482 of 09/12/2014, SEFRAM informs you of the availability of spare parts of products placed on the market as of March 1, 2015:

Spare parts are not available to the consumer. SEFRAM offers the supply of spare parts during repair by its service.

Consumable parts are provided according to the legislation applicable to them (case of batteries).

SEFRAM is committed to providing parts or alternatives for a period of at least 2 years beyond the warranty period.

TABLE OF CONTENTS

1	Important information	9
1.1	Particular precautions	9
1.2	Security instructions	9
1.3	Symbols and definitions	9
2	Presentation	11
2.1	General	11
2.2	Description of the appliance	12
3	Power-up	13
3.1	Battery	13
3.2	Battery charge	13
3.3	External power supply	14
3.4	Turning the appliance on and off	14
4	Quick start-up	15
4.1	Installing a TERRESTRIAL antenna	15
4.1.1	Use of the POINTING function	15
4.1.2	Use of the SPECTRUM function	17
4.2	Installing a SATELLITE dish	19
4.2.1	Use of the POINTING function	19
4.2.2	Use of the SPECTRUM function	22
4.3	Verifying an installation	25
5	Man-machine interface	26
5.1	Content of the screen	26
5.2	Lists of measurements and setup library	28
6	Measurement lists	30
6.1	The list page	30
6.2	Modification of a list	31
7	Setup library	34
7.1	The library page	34
7.2	Creation or modification of setups in the library	34
8	Check Sat	37
8.1	Functioning	37
8.2	Updating satellites	38
8.3	Instruction for use	38
8.4	Checking the aligned satellite	39
8.5	Double Check Sat	40
8.5.1	Recall	41
9	TERRESTRIAL check	42
9.1	Functioning	42
9.2	Transmitter update	43
9.3	Instruction for use	43
9.4	Vérification de l'émetteur pointé	44

10	AUTOSET mode	45
10.1	Terrestrial mode.....	46
10.2	Satellite mode	46
10.3	Cable Mode	46
10.4	«START » menu key	47
11	Measures	48
11.1	Modification of parameters	49
11.2	Utilisation de la Liste de mesure.....	49
11.3	Autolock function	50
11.4	Level measurements	50
11.4.1	Satellite band	51
11.4.2	Terrestrial band	51
11.4.3	Thresholds	52
11.5	Digital measurements	52
11.6	DVB-T	54
11.7	DVB-T2 /T2 Lite	55
11.8	DVB-C.....	56
11.9	DVB-C2.....	57
11.10	DVB-S / DSS	58
11.11	DVB-S2 / S2X	59
11.12	Multistream	60
12	Spectrum analyzer	61
13	Image and Sound	62
13.1	Digital TV	62
13.2	External analog video	63
13.3	Audio.....	63
13.4	Table of services.....	64
14	Remote power supply / LNB – DiSEqC	65
14.1	Terrestrial band.....	65
14.1.1	Power ON.....	65
14.2	Satellite band	66
14.2.1	Power ON.....	66
14.2.2	LNB type	67
14.2.3	Switches.....	68
14.2.4	Motorized Satellite dish control	69
14.2.5	DCSS	70
14.2.6	SATCR (EN50494).....	71
14.2.7	SCD2 (EN50607)	72
14.2.8	Influence of the DCSS on the spectrum analyzer	72
15	Constellation	73
16	Multipath / Guard interval	74
17	Measurement map	76
17.1	Out of tolerance values.....	77

18 Optical measurement 7859B	78
18.1 Presentation of the optic measurement.....	78
18.2 What you need to know	79
18.2.1 The optical fiber.....	79
18.2.2 Connectors.....	80
18.3 Optical power measurement.....	81
18.4 The satellite reception via optical fiber	82
18.5 Fiber reception after coupler.....	83
19 Configuration	84
19.1 Language.....	84
19.2 Measurement unit.....	84
19.3 Frequency map.....	85
19.4 Memories	86
19.4.1 View	87
19.4.2 Save	87
19.4.3 Update.....	88
19.5 Factory recovery	89
19.6 Configuration import/export	90
20 Software update	91
21 Save	92
22 Connection of the appliance to a PC	93
23 Displayed messages	95
23.1 Alert messages	95
23.2 Error messages	96
24 Maintenance	97
25 Technical specifications	99
25.1 Selection guide	99
25.2 Technical specifications.....	100
25.3 Digital measurements.....	101
25.4 Optical measurements (7859B).....	104
25.5 Divers.....	105
25.6 General specifications	106
25.7 Accessories	106
25.8 dB μ V, dBmV et dBm conversion	107
25.9 Typical values for measurements.....	107
26 Terminology	108

1 Important information

Please read carefully the following instructions before using your appliance.

1.1 Particular precautions

- Do not use the product for any other use than specified.
- Use the provided charger unit to prevent any deterioration of the appliance and guarantee its measurement characteristics. Charging battery with appliance switched off only (room temperature 0-35°C)
- Do not use in a wet environment.
- Do not use in an explosive environment.
- In case of failure or for the maintenance of the appliance, only a qualified personal shall be entitled to work on it. In such a case, it is required to use Sefram spare parts.
- Do not open the appliance: risk of electric shock.
- You should use the F/F adaptor provided with your measuring instrument. Any other adaptor could damage your appliance and jeopardizes the guarantee.
- Do not use gloves, stylus or any other object on to the touchscreen. Handle the screen carefully.

1.2 Security instructions

For a correct use of the appliance, it is necessary that users abide by the security and use instructions described in this manual.

Specific warnings appear all along this manual.

In case of need, warning symbols are displayed on the appliance:



1.3 Symbols and definitions

Symbols in this manual:



Remark: Shows important information



Key or press zone



Window or display zone showing up after the operation achieved

Symbols on the appliance:



Attention: Refer to the manual. Shows a risk of damage for the material connected to the instrument or to the instrument itself.



Ground: Grounded accessible parts.



Product for recycling.

2 Presentation

2.1 General

The field strength meters **7849B-7859B-7817B** are appliance designed for the installation and maintenance of any broadcasting and reception installations of analogical and digital terrestrial television channels, satellites or cable networks, for RF or optical modulated signals.

The band ranges between **5 MHz to 2400 MHz**; this allows accurate measurements on all analogical television standards, FM carrier waves and the various digital standards DVB-C/C2, DVB-T/T2/T2Lite, DVB-S/S2/S2X and DSS.

They do **Level** measurements in average, peak and power according to the selected standard

In **Measurement Plan** mode, they scan up to 50 setups at the same time and compare them to decision levels (min / max).

Equipped with an efficient **Bit Error Rate** measurement (various BER, MER), they allow the full validation of digital transmissions DVB-T/T2/T2Lite, DVB-C/C2, DVB-S/S2/S2X and DSS.

Providing a **Constellation** diagram for digital standards, the detection and display of **Multipaths** permit to complete this analysis.

You can display the **digital terrestrial or satellite TV** (free programs) under SD or HD.

You can hear digital sound through integrated loudspeakers.

The **7859B** has an Optical input (optical head, FTH cable): it integrates an optical power measurement and an optical-to-RF converter in the Field Measurer band.

The **7817B** has a special "One-Touch" feature designed to qualify the installations of subscriber broadcast networks.

Designed for use on field, they are compact (less than 2 kg battery included), autonomous (battery pack and quick charger), equipped with a LCD 7" touchscreen (capacitive).

The high memory content allows the storage of many configurations, measurements and spectrum curves.

The appliances fully remote-controlled through USB and ETHERNET connections via a computer.

2.2 Description of the appliance

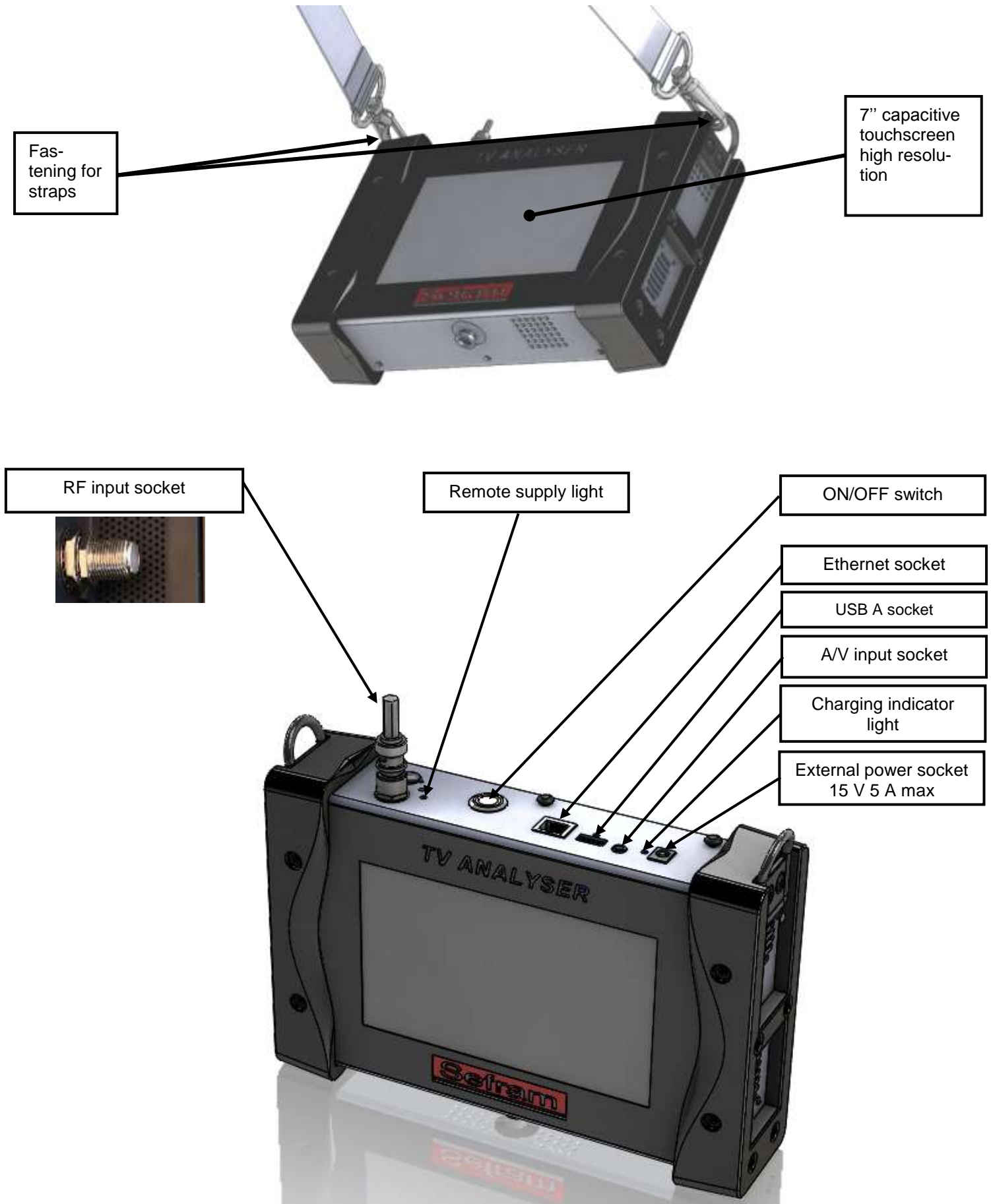

3 Power-up

All the material is checked before shipment and delivered in an adapted packaging.

There is no particular unpacking instruction.

The appliance is equipped with a Lithium-Ion (Li-ion) battery. It is shipped with the battery loaded.

However, if the appliance has remained idle more than one month long, check its charge state and reload if required.

The device has a capacitive touch slab.

Use with gloves is not possible.

In order not to damage your screen, do not use a stylus or object.

3.1 Battery



Attention: Any intervention on the battery requires the disassembly of the appliance and should be made by a SEFRAM technician.

Use only batteries provided by SEFRAM.

Security advice:

- Do not throw into the fire or heat up the battery pack
- Do not shunt the parts of the battery: risk of explosion!
- Do not drill
- Do not disassemble the battery pack
- Do not reverse the polarities of the battery
- This battery pack includes a protective item that should not be damaged or removed
- Protect the pack from the heat while storing
- Do not damage the protective sheath of the pack
- Do not store the appliance in a vehicle under sunlight
- Used batteries are not for domestic waste; lithium batteries should be recycled.

The battery has a 200-charge-discharge cycle life or 2 years.

Advice to extend the life of your battery:

- Avoid deep discharges
- Do not store the batteries too long without using them
- Store the battery around 40% loading
- Do not fully charge or fully discharge the battery before storage.

When the battery is almost fully discharged, the appliance will warn “Low battery”, and then will shut off after a few minutes.

3.2 Battery charge

To charge the battery inside the appliance:

- Connect the external power supply provided through the jack plug of the appliance (above)

- Connect the power supply on the mains
- The internal charger starts loading the battery; the green lamp lights up.



Charge the device only when the device is off.
Charge the device only with the provided power supply block.

3.3 External power supply

The appliance works under 15V (1 A) power supply.

The power supply block provided is an external power supply too.

Only use the power supply block provided with the appliance.

Use of another mains block could damage your appliance and would not valid the guarantee.

3.4 Turning the appliance on and off

Press the button on the right side of the appliance:

The entry page appears on screen.



The ON/OFF button **lights up** when the appliance is working.

Pressing the ON/OFF button for a long time **forces the shut-off** of the appliance :
proceed this way only in case of necessity.

Pressing this button turns the appliance off.

4 Quick start-up

4.1 Installing a TERRESTRIAL antenna

You have two methods to install a terrestrial antenna :

- using the POINTING function
- using the SPECTRUM function

4.1.1 Use of the POINTING function

The appliance gets an “Antenna pointing” mode in order to align quickly and easily your terrestrial antenna. To access to the “Antenna pointing” mode from the HOME page, press



→ Select the emitter to point to in the pre-informed list: (example ST ETIENNE) :

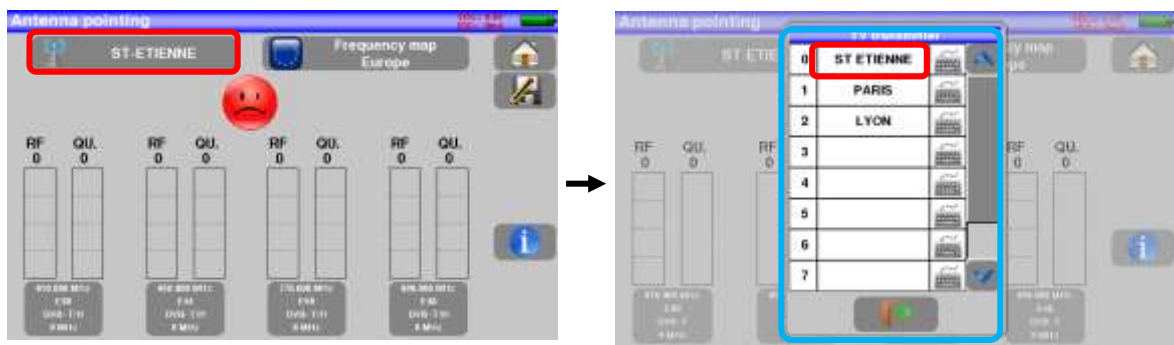

→ The device successively scans 4 channels and gives an RF indication corresponding to the level of the signal received on the antenna and QUALITY corresponding to the quality of the signal received on the antenna.

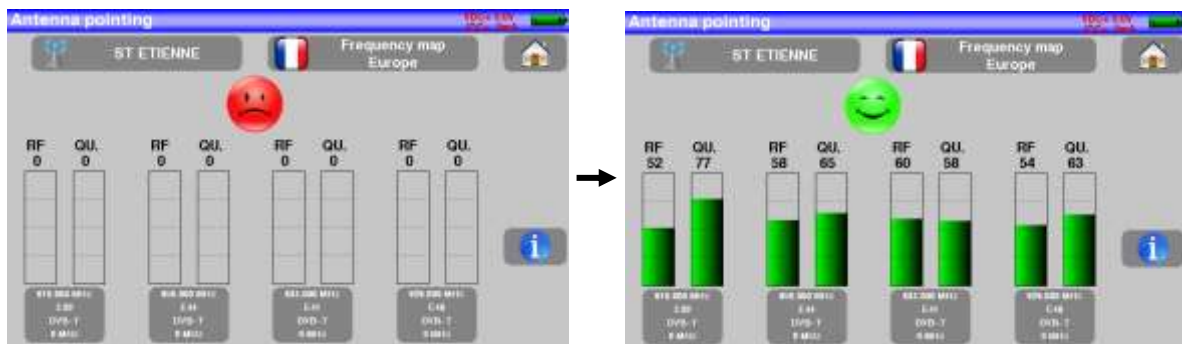

Uncorrectly pointed antenna

Correctly pointed antenna



No transmitter found, bad reception quality → red smiley



Average reception quality (< 50%) → orange smiley



Good reception quality (> 50%) → green smiley

→ Slowly orientate the antenna until hearing the locking melody and getting the best quality

→ The key  validates your transmitter by displaying the TV channels of each channel :

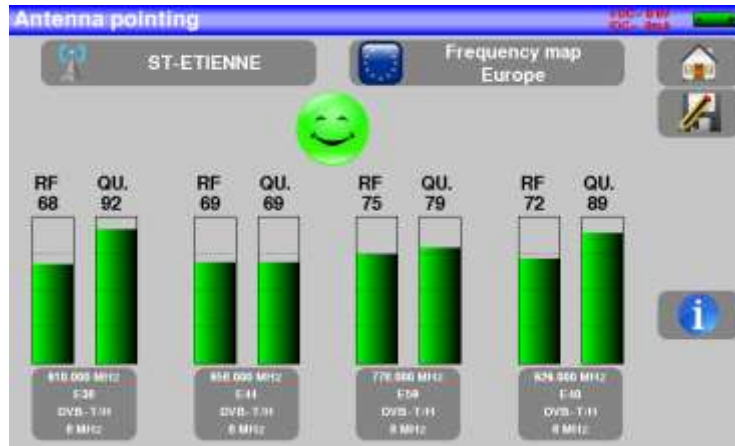

The 4 frequencies or channels of the transmitter you are trying to point are changeable depending on your location :

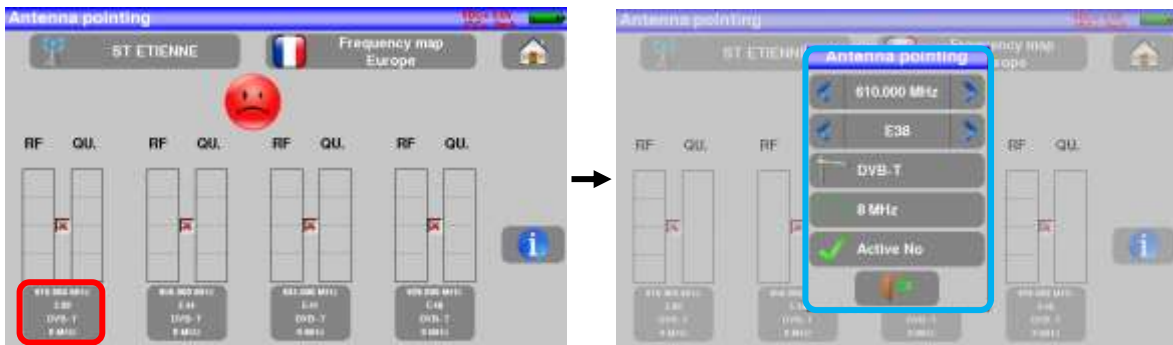

You can save a new transmitter to find it among the possible 10 :

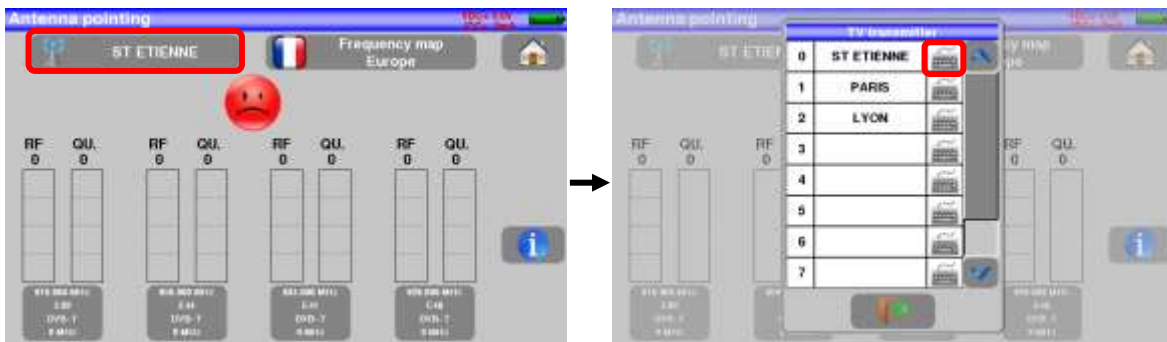

4.1.2 Use of the SPECTRUM function

Turn your appliance on. Press the Measures key



Press the Spectrum function

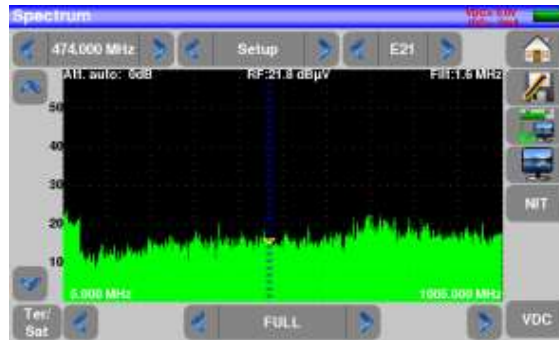

→ Access to full SPAN mode

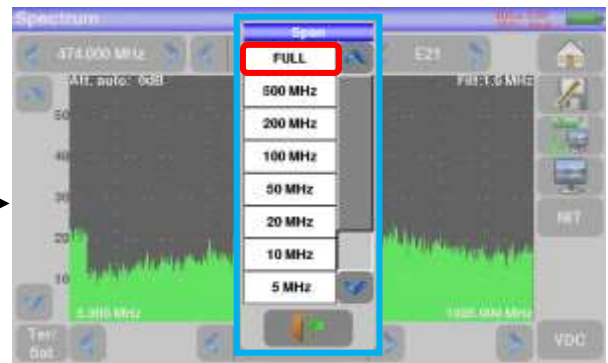
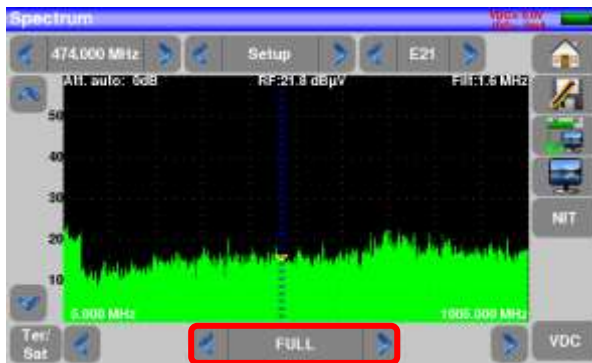

→ Choose a known CHANNEL :

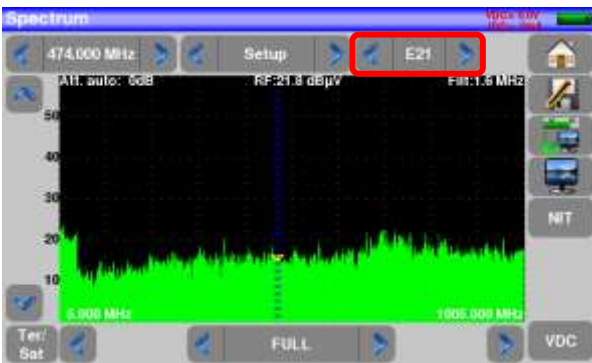

→ Adjust slowly the antenna to get the most powerful signal possible

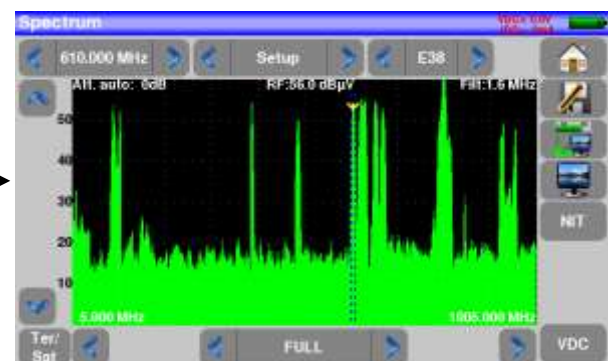
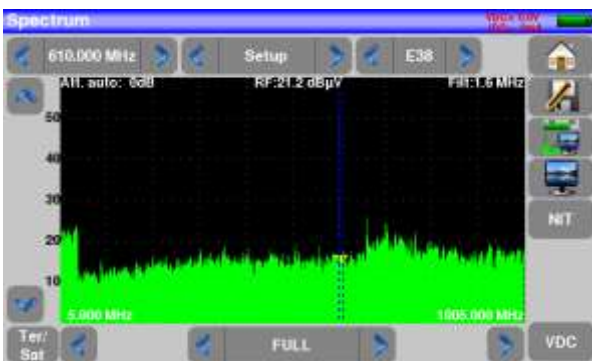

→ Press the NIT key , the device find automatically all the parameters of the signal. Once the search ended, the device display the “Network Name” and the “Network ID”.



You can now do all the measurements, level, BER/MER and access the TV display :



4.2 Installing a SATELLITE dish

You have two methods to install a satellite dish :

- using the POINTING function
- using the SPECTRUM function

4.2.1 Use of the POINTING function

The appliance gets an “Dish pointing” mode in order to align quickly and easily your satellite dish. To access to the “Check Sat” mode from the HOME page, press



→ Select a satellite like in the example below (here Astra1):

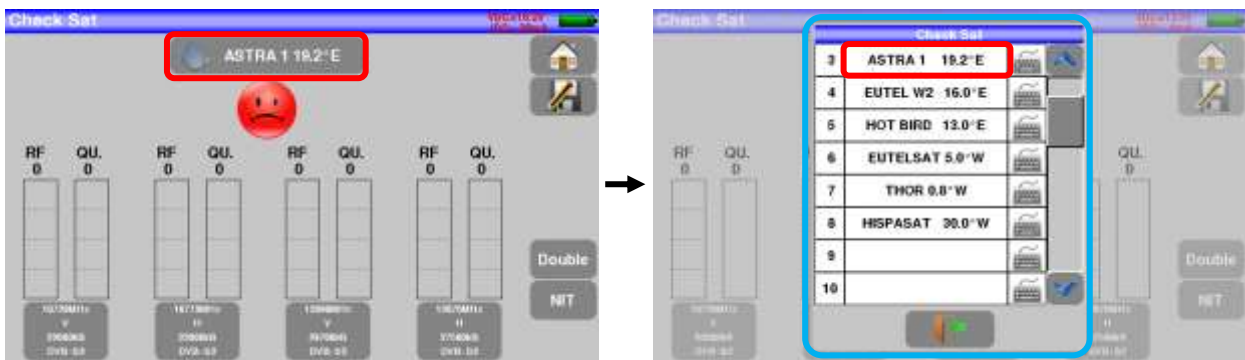

→ The device successively scans 4 transponders and gives an RF indication corresponding to the level of the signal received on the antenna and QUALITY corresponding to the quality of the signal received on the antenna.

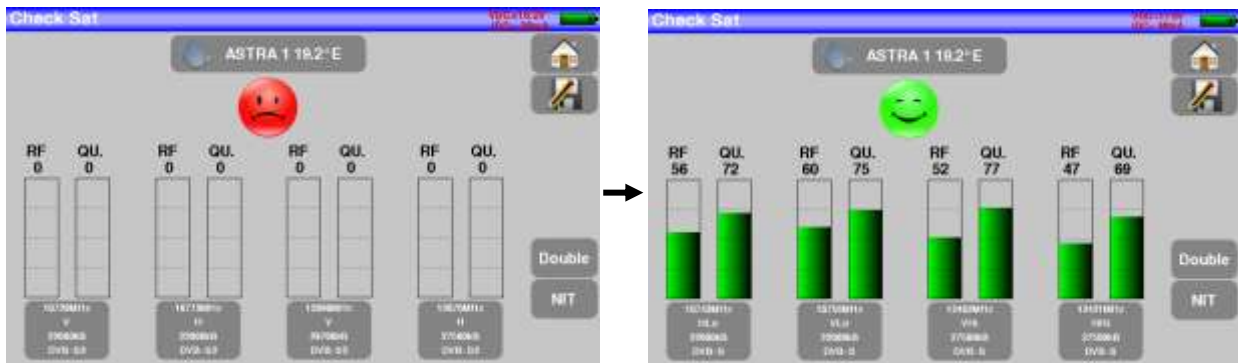

Uncorrectly pointed antenna

Correctly pointed antenna



No found transponder → red smiley

Average reception quality (< 50%) → orange smiley

Good reception quality (> 50%) → green smiley

→ Slowly orientate the satellite dish until hearing the locking melody and getting the best quality

Reminder: a satellite antenna must be powered by direct current: remote power supply

To access to the Remote power supply page, press 



Check for tension and current consumed by your dish's LNB :



➔ To check if the aimed satellite is the right one : press the NIT key 

The appliance searches the MPEG NIT table on one of the 4 transponders and displays the name of the satellite:



	<p>Attention:</p> <p>The displayed name depends on the content of the MPEG NIT table. Some distributors provide no (or poor) such table. The displayed information may be wrong.</p>
---	---

The 4 frequencies or transponders of the satellite you are trying to point are editable :

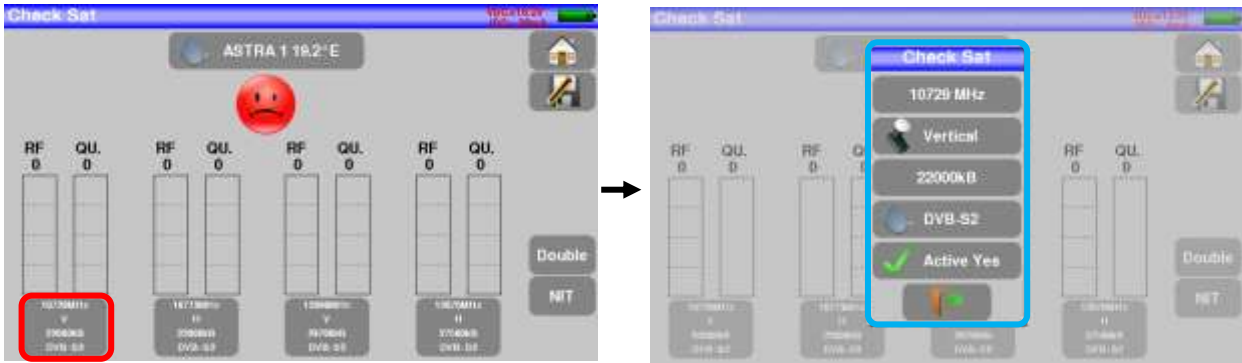



Attention:

To identify a satellite, you must be locked on all 4 transponders. (Quality > 0)

However, some transponders are regularly modified. See the frequency range of the satellite when a transponder does not seem to work.

Some switches or LNB work only with DiSEqC commands.

In this case, position the band (OL) and the polarization on DiSEqC at the Configuration page LNB-DiSEqC.

(Attention: the Check Sat is slower when using the DISEqC command).

You can save a new satellite to find it among the possible 10 :

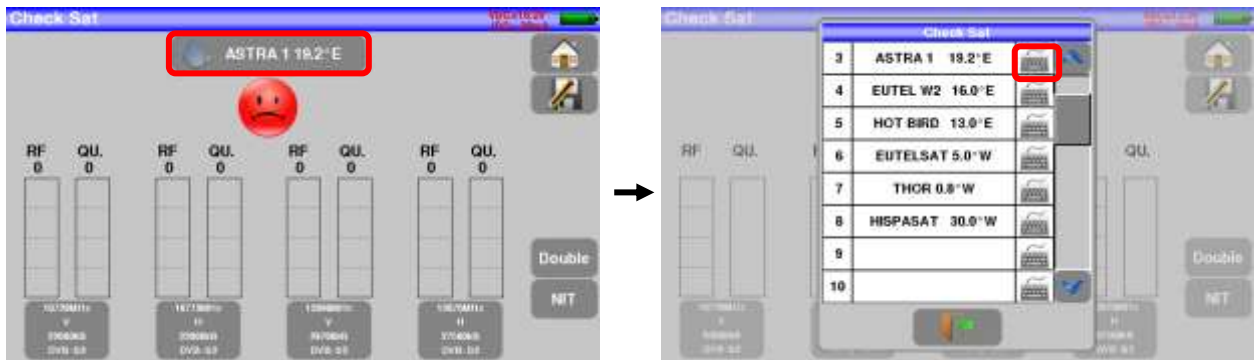

4.2.2 Use of the SPECTRUM function

Turn your appliance on. Press the Measures key



Press the Spectrum function

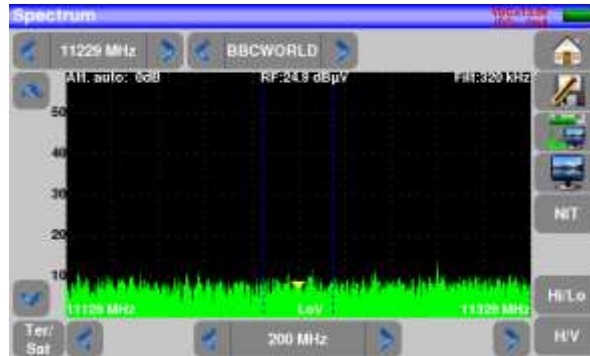

➔ Access to full SPAN mode

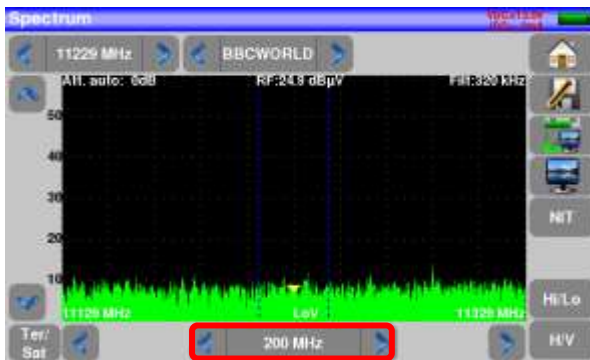

➔ Choose a known TRANSPONDER :

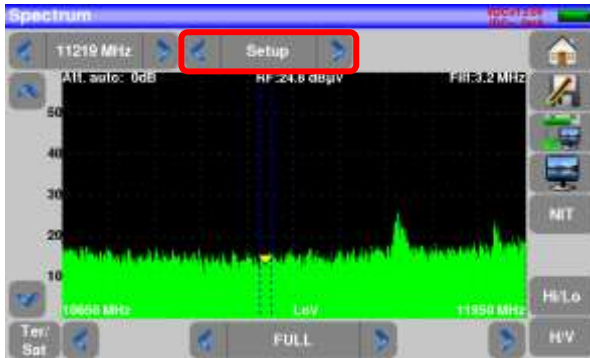

➔ Adjust slowly the dish to get the most powerful signal possible

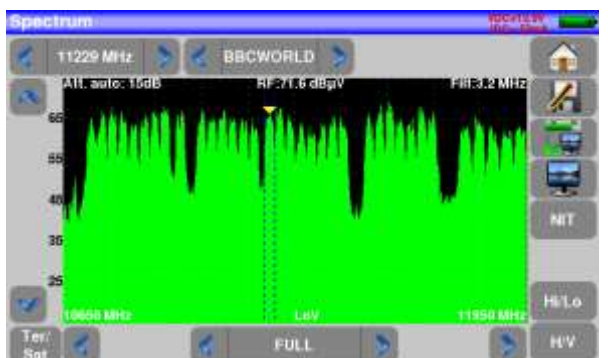
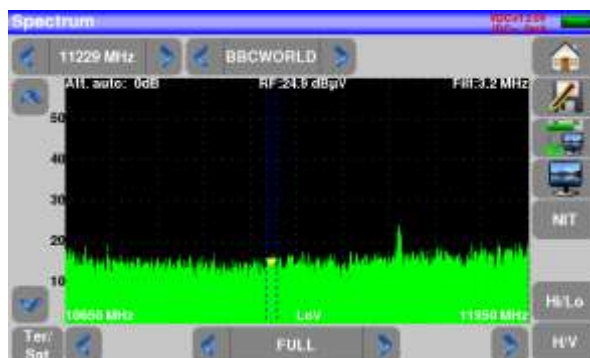



Reminder: a satellite antenna must be powered by direct current: remote power supply

To access to the Remote power supply page, press 

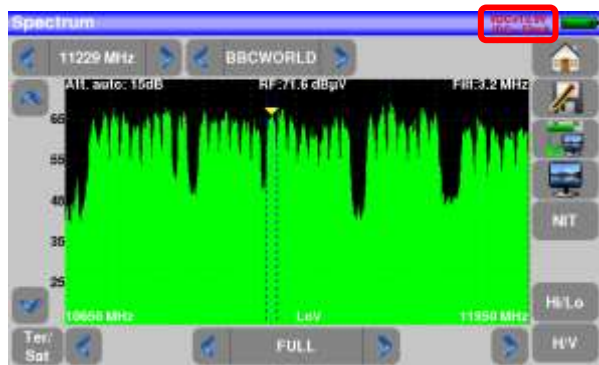

Check for tension and current consumed by your dish's LNB :



- Then press the button  . The device automatically searches for signal settings.
Once the search is complete, the device displays the "Network Name" and the "Network id"



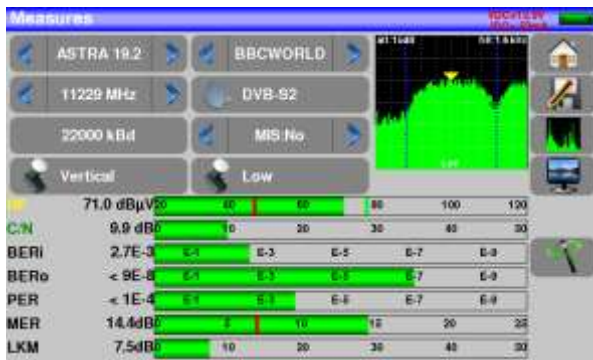

You can now do all the measurements, level, BER/MER and access the TV display :



4.3 Verifying an installation

The device allows you to check an existing RF signal distribution installation, whether on terrestrial, satellite, by coaxial cable or optical fiber.

An AUTOSET function automatically detects all distributed channels, and scans them one after the other through the MEASUREMENT MAP function.

Presse the key Home , then press Autosee 



See more details in the "AUTOSET" chapter.

Once the SCAN is done according to your settings, the MEASUREMENT MAP function is automatically launched :

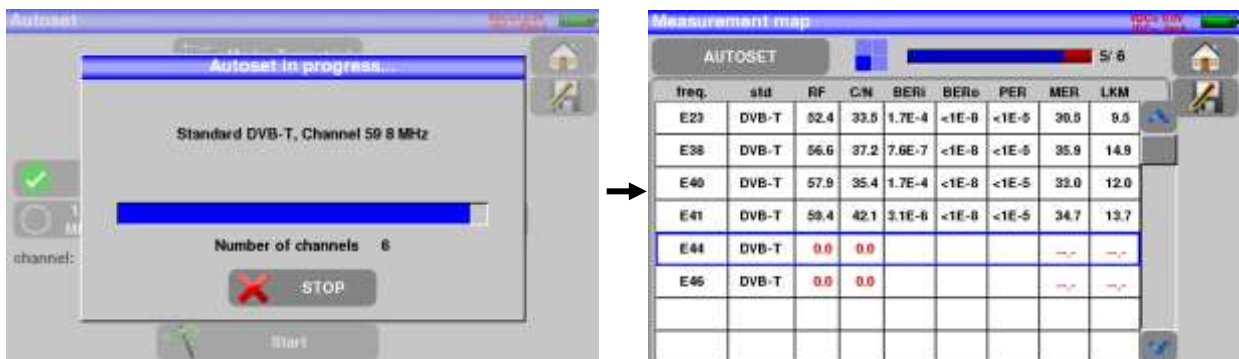

This allows you to have a summary of all the channels received on the installation, along with their associated measurements.

5 Man-machine interface

5.1 Content of the screen

The appliance has a capacitive touchscreen.

No glove should be used.

If you don't want to damage your screen, do not use any stylus or object.

You can recognize the « keys » by their dark grey frame, example the Home key:

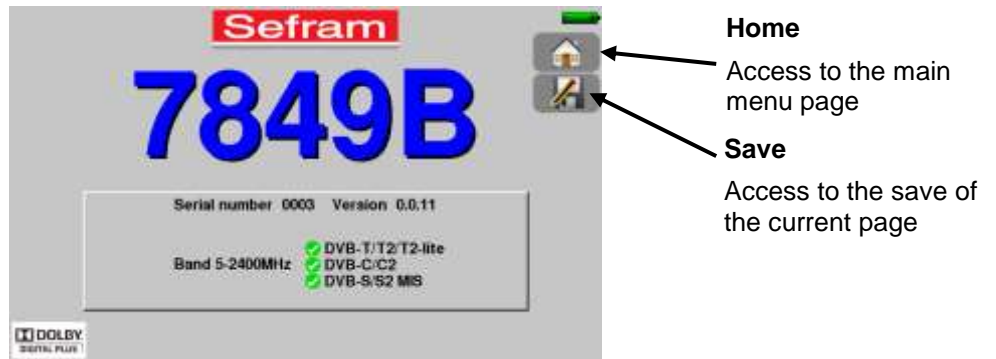

The Home page allows the navigation through all functions of the appliance : config, measures, ...



On all pages is displayed the following information:

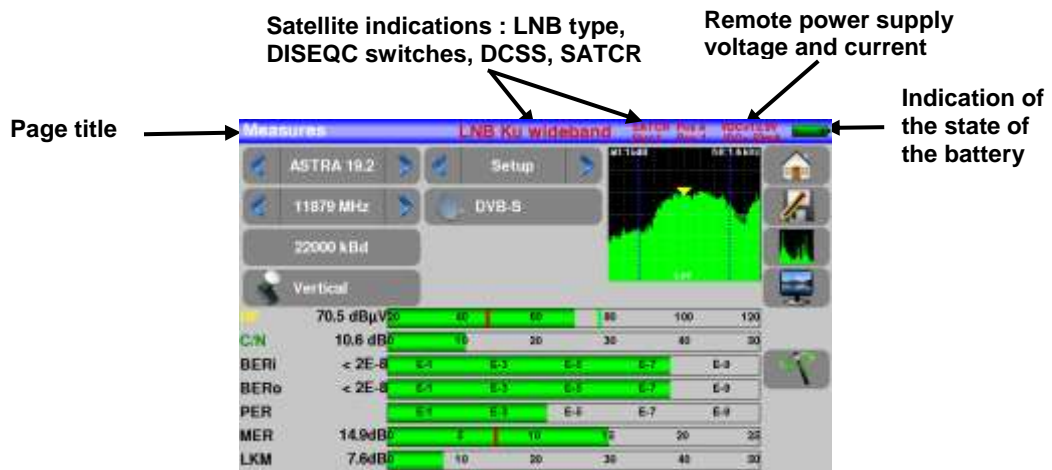

7849B – 7859B – 7817B

To navigate through a table inside a page or a window, a vertical slide appears with arrows to move up and down the table.

To move faster, you can slide a cursor with your fingers.

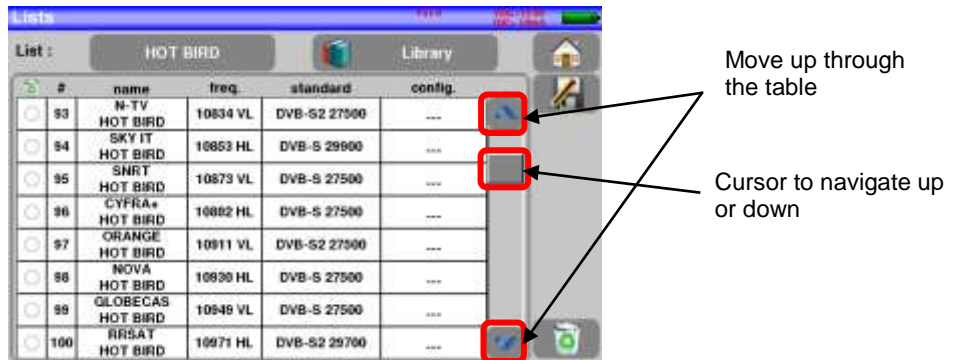

To validate the choice of a line of a table, simply press this line: choosing a program/channel, choosing a signal setting, choosing a TV image, etc.

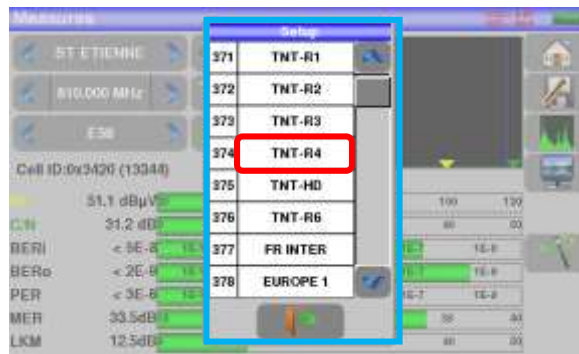

Values or text is entered by a virtual keyboard:



5.2 Lists of measurements and setup library

In order to make easier the recall of data on field, the appliance uses 20 **Measurement Lists** of each 50 lines and 1000 setups from a **Library**.

A setup corresponds to a terrestrial, cable or satellite emission.

A list of measurements corresponds to a particular installation: presence of several satellite dishes, of various switches...

Example of list (the background of the table is white)

#	name	freq.	standard	config.
371	TNT-R1 ST-ETIENNE	E38	DVB-T/H 8M GI auto	---
372	TNT-R2 ST-ETIENNE	E44	DVB-T/H 8M GI auto	---
373	TNT-R3 ST-ETIENNE	E59	DVB-T/H 8M GI auto	---
374	TNT-R4 ST-ETIENNE	E40	DVB-T/H 8M GI auto	---
375	TNT-HD ST-ETIENNE	E49	DVB-T/H 8M GI auto	---
376	TNT-R6 ST-ETIENNE	E46	DVB-T/H 8M GI auto	---
377	FR INTER ST-ETIENNE	88.000	FM	---
378	EUROPE 1 ST-ETIENNE	104.800	FM	---

Example of library (the background of the table is yellow)

#	name	freq.	standard
0	DIGITAL+ ASTRA 1	10728 VL	DVB-S2 22000
1	ARD ASTRA 1	10743 HL	DVB-S 22000
2	ANIXE HD ASTRA 1	10773 HL	DVB-S2 22000
3	DIGITAL+ ASTRA 1	10788 VL	DVB-S 22000
4	DIGITAL+ ASTRA 1	10817 VL	DVB-S2 22000
5	HD+ ASTRA 1	10832 HL	DVB-S2 22000
6	DIGITAL+ ASTRA 1	10847 VL	DVB-S 22000
7	TVP HD ASTRA 1	10861 HL	DVB-S 22000

The same setup may be used in several measurement lists.

The same installation may use two satellite dishes

ASTRA 19.2 in DiSEqC position A

HOT BIRD 13 in DiSEqC position B

Another one may use three satellite dishes

ATLANTIC BIRD 3 in DiSEqC position A

ASTRA 1 in DiSEqC position B

HOT BIRD in DiSEqC position C

The same setup may be used several times in the same measurement list.

ZDF SatCR slot 0

ZDF SatCR slot 1

ZDF SatCR slot 2

ZDF SatCR slot 3...

If a parameter of a setup changes, for example a modification of rate or change from DVB-S to DVB-S2, only the setup inside the library should be updated.

A list of measurements is made of:

- a list name in 10 characters
- the lowest frequency of the LNB (OL1)
- the highest frequency of the LNB (OL2)
- the selection mode low band / high band of the LNB
- the selection mode of the polarization
- the presence of the position number of the positioner (motorized satellite dish)
- 50 lines including each:
 - a setup number corresponding to the setup list
 - the presence and the functioning mode of the switch, committed type
 - the position of the switch, committed type
 - the presence and the functioning mode of the switch, uncommitted type
 - the position of the switch, uncommitted type
 - the presence of SatCR equipment
 - the SatCR slot number
 - the position of the SatCR switch

A few of these parameters are specific to the waveband of the satellite and have no influence in terrestrial and cable modes.

A setup is made of:

- a setup name in 8 characters
- a place name in 10 characters
- a frequency
- a channel number in terrestrial or cable mode
- a frequency map in terrestrial or cable mode
- a vertical or horizontal polarization in satellite mode
- a low or high LNB band in satellite mode
- a standard
- an analogical mono stereo or NICAM mode in terrestrial or cable mode
- a constellation type 64QAM 256QAM under DVB-C
- a bandwidth 5, 6, 7 or 8 MHz under DVB-T and DVB-T2
- a symbol rate under DVB-C, DVB-S, DVB-S2 or DSS

According to the terrestrial, cable or satellite band mode and to the standard, some parameters have no influence.

The place name may distinguish two distinct emitters, example TF1 Fourvière and TF1 Chambéry.

Frequency and channel number are equivalent: a valid channel number has priority over a frequency.

The frequency map parameter associated with the setup allows frontiersmen to keep on using channel numbers.



Selecting a list in the **Lists** page automatically recalls all information associated with this list.



Selecting a **Setup** on a measurement page automatically recalls all information associated with this setup.

6 Measurement lists

6.1 The list page

In this page, you can select the list where you will work on measurements.

Pressing Home  then Lists-Library  gives you access to the **Lists** function:

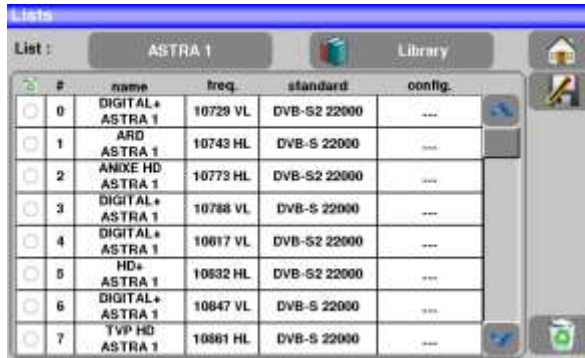

#	name	freq.	standard	config.
0	DIGITAL+ ASTRA 1	10729 VL	DVB-S2 22000	---
1	ARD ASTRA 1	10743 HL	DVB-S 22000	---
2	ANIXE HD ASTRA 1	10773 HL	DVB-S2 22000	---
3	DIGITAL+ ASTRA 1	10788 VL	DVB-S 22000	---
4	DIGITAL+ ASTRA 1	10617 VL	DVB-S2 22000	---
5	HD+ ASTRA 1	10632 HL	DVB-S2 22000	---
6	DIGITAL+ ASTRA 1	10847 VL	DVB-S 22000	---
7	TVP HD ASTRA 1	10861 HL	DVB-S 22000	---

Lists are ranked from 0 to 19. To select the one you want, press the following key. Lists are displayed. Press the one you want:

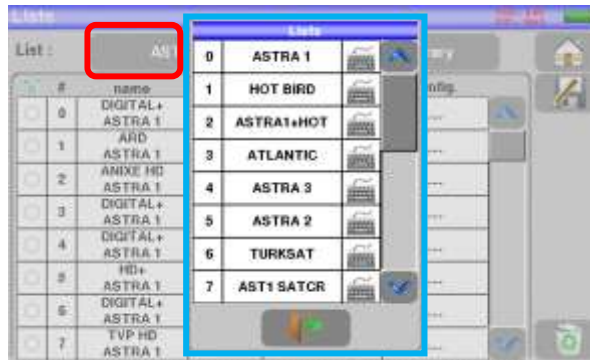

#	name
0	ASTRA 1
1	HOT BIRD
2	ASTRA1+HOT
3	ATLANTIC
4	ASTRA 3
5	ASTRA 2
6	TURKSAT
7	AST1 SATCR

In this example, we selected ST ETIENNE.



#	name	freq.	standard	config.
6	TURKSAT			
7	AST1 SATCR			
8	ST ETIENNE			
9	AST+ST-ET			
10	AUTOCSET			
11				
12				
13				

#	name	freq.	standard	config.
371	TNT-R1 ST-ETIENNE	E38	DVB-T/H 8M GI auto	---
372	TNT-R2 ST-ETIENNE	E44	DVB-T/H 8M GI auto	---
373	TNT-R3 ST-ETIENNE	E09	DVB-T/H 8M GI auto	---
374	TNT-R4 ST-ETIENNE	E40	DVB-T/H 8M GI auto	---
375	TNT-HD ST-ETIENNE	E49	DVB-T/H 8M GI auto	---
376	TNT-R5 ST-ETIENNE	E46	DVB-T/H 8M GI auto	---
377	FR INTER ST-ETIENNE	38.090	FM	---



6.

Attention: A list may contain a Satellite and a Terrestrial setup.

6.2 Modification of a list

To change the name of the list of ST ETIENNE, you must push on its name, then on the symbol of the keypad. A virtual keypad shows up. Type the new name (SEFRAM in our example).

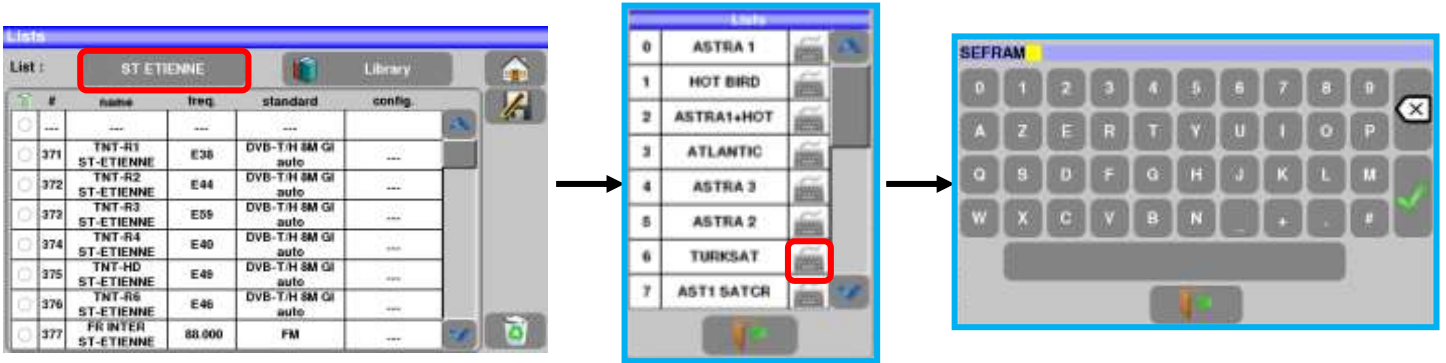

To add a setup to the list, select the line. A window shows up:

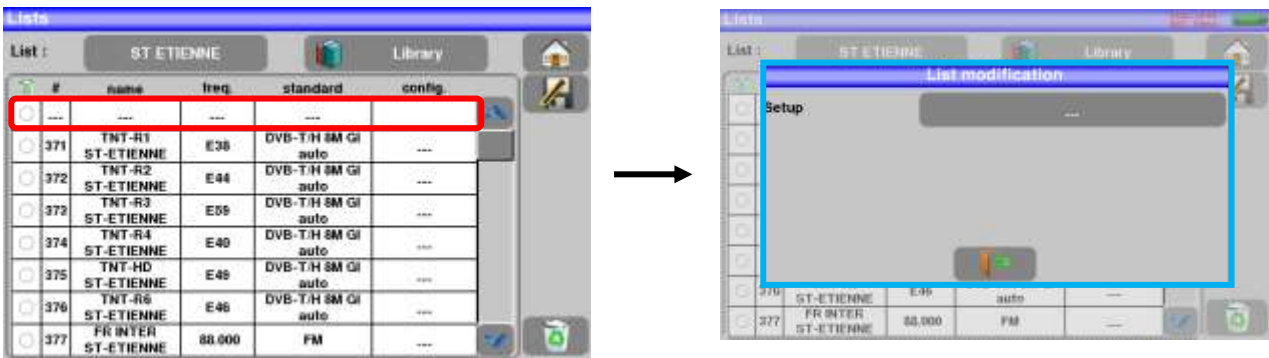

Attention: If the line contains a setup, it shall be erased. To cancel, press:

By pressing the key before Setup, you disclose the available setups from the library (you cannot create a setup from a list; to create a setup, see [Setup creation or modification in the library](#)):



Scroll the list up or down to find the setup you want to add to your list. Press the line you want:

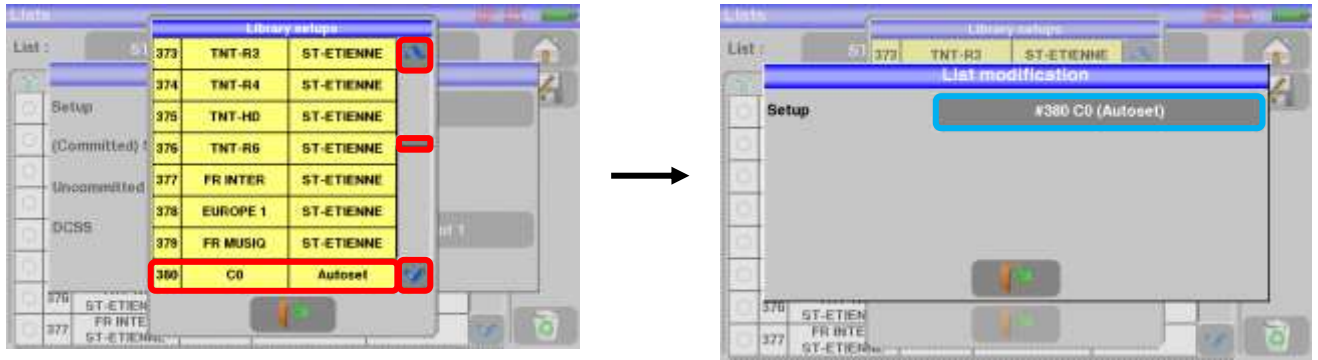

The setup is now in the list:

#	name	freq.	standard	config.
360	C0 Autoset	E36	DVB-T/H 8M Gi auto	---
371	TNT-R1 ST-ETIENNE	E38	DVB-T/H 8M Gi auto	---
372	TNT-R2 ST-ETIENNE	E44	DVB-T/H 8M Gi auto	---
373	TNT-R3 ST-ETIENNE	E59	DVB-T/H 8M Gi auto	---
374	TNT-R4 ST-ETIENNE	E40	DVB-T/H 8M Gi auto	---
375	TNT-HD ST-ETIENNE	E49	DVB-T/H 8M Gi auto	---
376	TNT-R6 ST-ETIENNE	E46	DVB-T/H 8M Gi auto	---
377	FR INTER ST-ETIENNE	88.000	FM	---

You may erase the setup from the list by pressing the check to the left of the setup or to the setups you have to delete. Then click the basket  and select the deletion of the selected setup:



#	name	freq.	standard	config.
---	---	---	---	---
371	TNT-R1 ST-ETIENNE	E38	DVB-T/H 8M Gi auto	---
372	TNT-R2 ST-ETIENNE	E44	DVB-T/H 8M Gi auto	---
373	TNT-R3 ST-ETIENNE	E59	DVB-T/H 8M Gi auto	---
374	TNT-R4 ST-ETIENNE	E40	DVB-T/H 8M Gi auto	---
375	TNT-HD ST-ETIENNE	E49	DVB-T/H 8M Gi auto	---
376	TNT-R6 ST-ETIENNE	E46	DVB-T/H 8M Gi auto	---
377	FR INTER ST-ETIENNE	88.000	FM	---

You can also delete the totality of a list by pressing directly on the basket  then by selecting



In a satellite setup, you can change the switch, the Uncommitted Port and the DCSS by activating any of these keys (this change will affect only the setup in this list, not in the library):

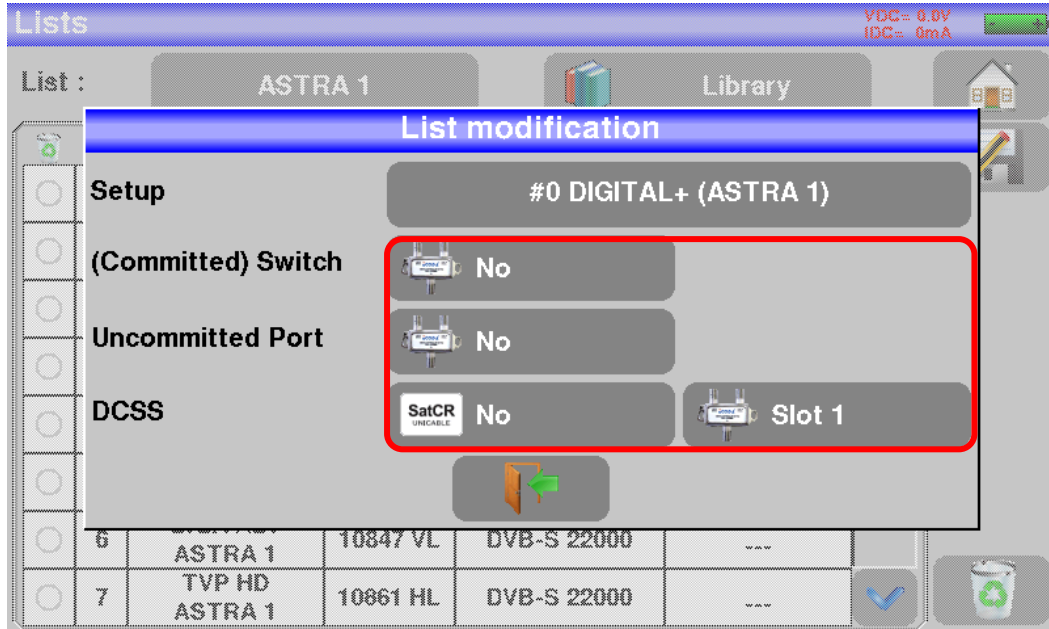



Lists VDC= 0.0V
IDC= 0mA



List : **ASTRA 1** Library Home

List modification

Setup #0 DIGITAL+ (ASTRA 1)

(Committed) Switch  No

Uncommitted Port  No

DCSS  No  Slot 1



6	ASTRA 1	10847 VL	DVB-S 22000	---	
7	TVP HD ASTRA 1	10861 HL	DVB-S 22000	---	✓ 

7 Setup library

7.1 The library page

By pressing Home  then Lists-Library , you can access the Lists function.

From there, you can access the Library by pressing the key .

Library setups

VDC= 0.0V
IDC= 0mA

Lists

#	name	freq.	standard
379	FR MUSIQ ST-ETIENNE	97.100	FM
380	C0 Autoset	E38	DVB-T/H 8M GI auto
381	C1 Autoset	E40	DVB-T/H 8M GI auto
382	C2 Autoset	E44	DVB-T/H 8M GI auto
383	C3 Autoset	E46	DVB-T/H 8M GI auto
384	C4 Autoset	E49	DVB-T/H 8M GI auto
385	C5 Autoset	E59	DVB-T/H 8M GI auto
386	---		

7.2 Creation or modification of setups in the library

To create or change a setup in the library, you have to select a line in the table. A window pops up:



Attention: If the line contains a setup, it will be erased. To cancel, press:



Library setups

VDC= 0.0V
IDC= 0mA

Lists

#	name	freq.	standard
368	---		
369	---		
370	---		
371	TNT-R1 ST-ETIENNE	E38	DVB-T/H 8M GI auto
372	TNT-R2 ST-ETIENNE	E44	DVB-T/H 8M GI auto
373	TNT-R3 ST-ETIENNE	E59	DVB-T/H 8M GI auto
374	TNT-R4 ST-ETIENNE	E40	DVB-T/H 8M GI auto
375	TNT-HD ST-ETIENNE	E49	DVB-T/H 8M GI auto



Library setups

VDC= 0.0V
IDC= 0mA

Setup modification

Name: 370

Satellite: ---

Frequency: 10729 MHz

Standard: DVB-S2

Polar./Band: Low Vertical

Symbol rate: 22000 kBd

Cancel icon (red X)

You may erase the setup from the list by pressing the check to the left of the setup or to the setups you have to delete. Then click the basket  and select the deletion of the selected setup:

From this window, you can create a terrestrial, satellite KU, L or C setup.

To proceed, see chapter 5 [Man-machine interface](#)

➤ **Terrestrial Setup:**

Under standard DVB-T/T2

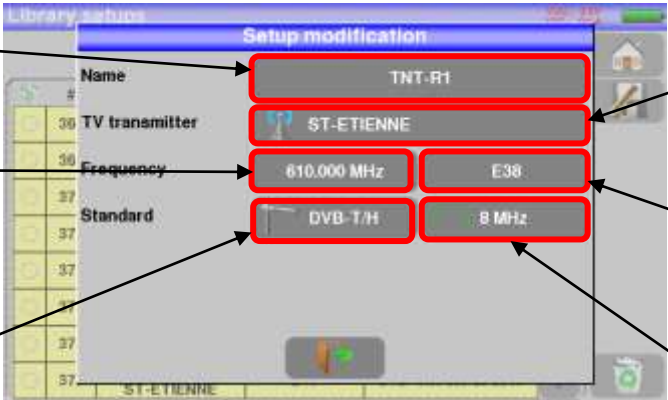

To enter the name you want for the setup

To enter the frequency you want for the setup

To enter the standard you want for the setup (DVB-T/H in this case)

To enter the Emitter/Satellite name you want for the setup

To enter the channel you want for the setup

To enter the frequency band you want for the setup

Under standard DVB-C/C2



To enter the symbol rate you want for the setup

In terrestrial analogical standard (L, BG, DK, I and MN)

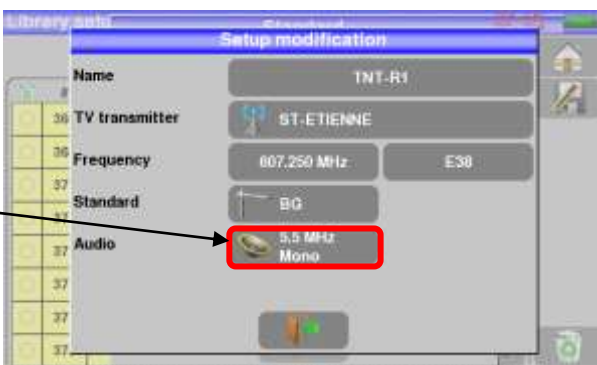

To enter the type of audio configuration you want for the setup (mono, stereo or NICAM)

➤ **Satellite Setup :**

To enter the type of polarity you want for the setup (high or low, vertical or horizontal)

To enter the symbol rate you want for the setup

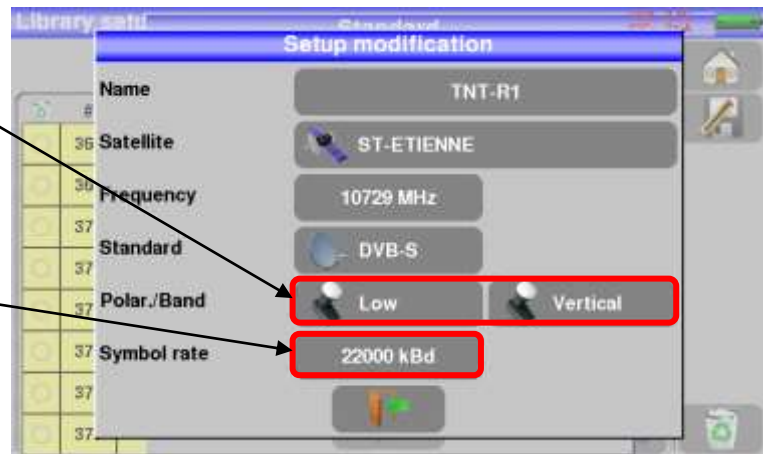

8 Check Sat

Press  and  to access the Check Sat mode.

8.1 Functioning

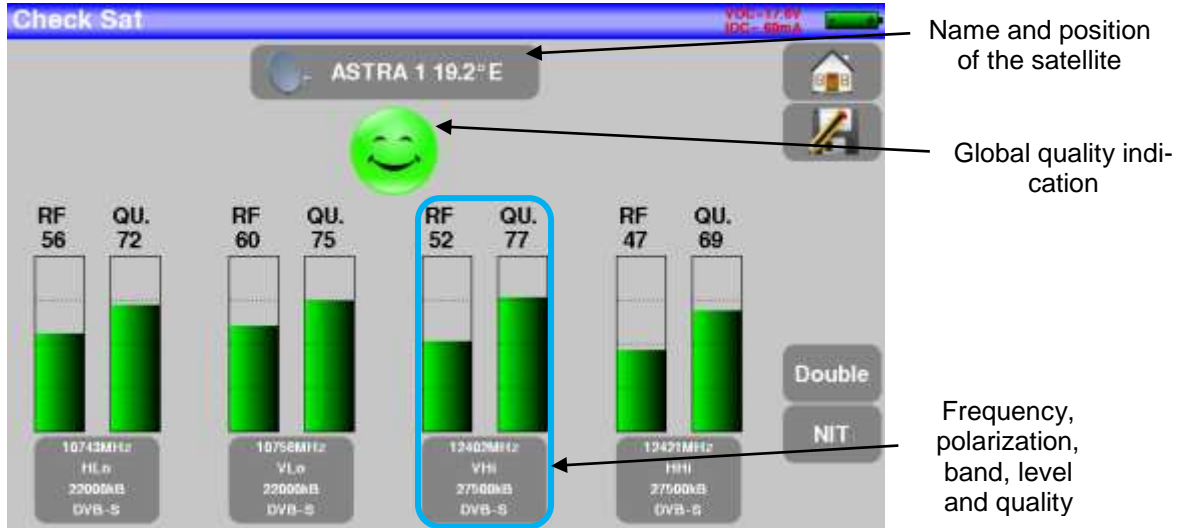

The appliance has 32 possible orbital positions for satellites. It is provided with near of 10 satellites registered.

4 transponders are appended to each satellite.

The device successively scans these 4 transponders and gives an RF indication corresponding to the level of the signal received on the antenna and QUALITY corresponding to the quality of the signal received on the antenna.

The satellite is chosen by selecting it from the pre-informed list: (example ASTRA 1)

To modify a transponder, you must press the corresponding key:

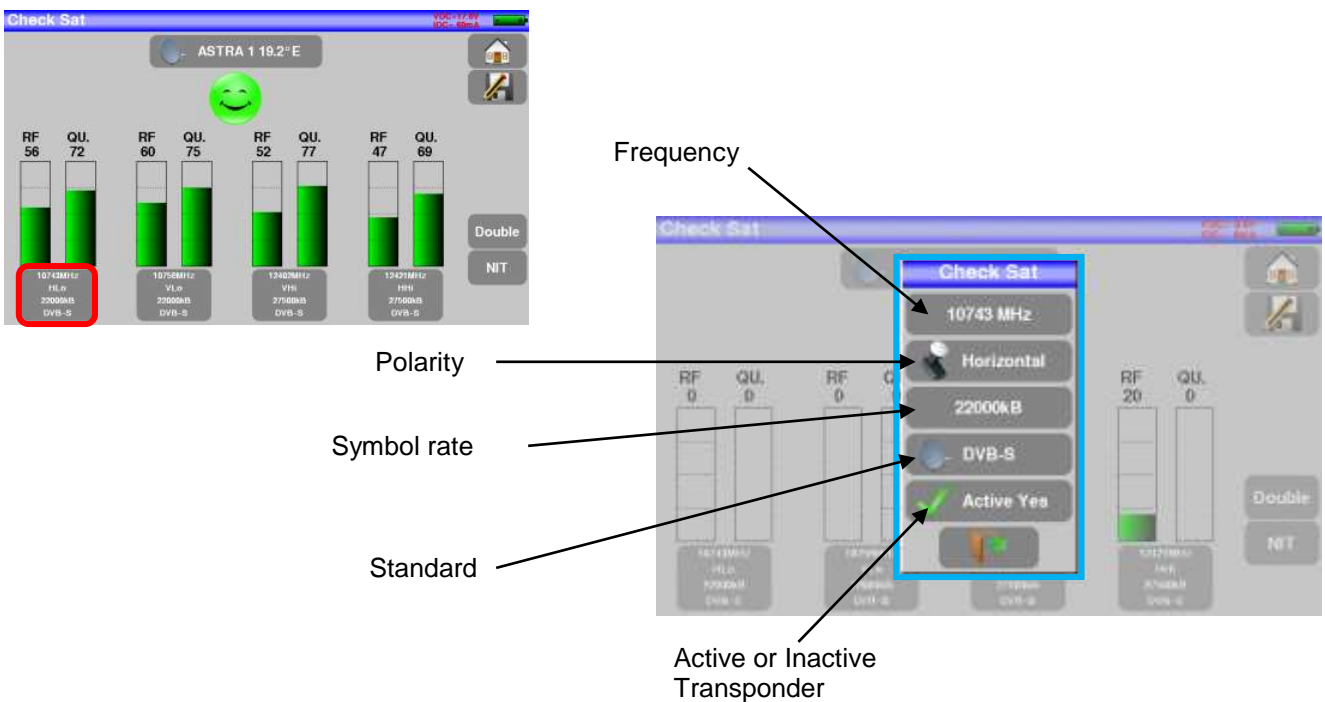

8.2 Updating satellites

You can update frequencies of the checks sat :

manually on your device

or

by importing the configuration posted on the SEFRAM website :

https://www.sefram.com/downloads/maj_soft/fr/Sat.csv

All you have to do is to copy this file on a USB stick and go to "Configuration" and then "Import"

We advise you to check and to update your frequencies every three months

8.3 Instruction for use

Procedure:

1/ Connect the satellite dish to the appliance and start it up.

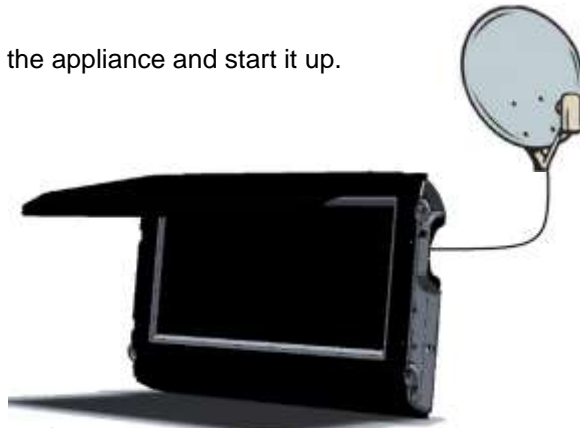

2/ Validate the remote power supply:

- VDC lights up.
- Check the power supply current of the LNB (IDC at the top right corner of the screen should be between 50 and 200 mA).

See chapter [Remote power supply / LNB – DiSEqC](#)

3/ On the Home page, go to the Check Sat mode.

Select the satellite to aim at in the list (example ASTRA1)



4/ Slowly orientate the satellite dish until hearing the locking melody and getting the best quality.

5/ Slightly turn the LNB to get the best quality (counter-polarization).

You will hear a melody as soon as a first transponder is detected; then, you will hear beeps. These beeps are closer and closer as the quality increases.



If the appliance is not synchronized on all four transponders, the quality indication is **red**.



If the appliance is synchronized on all four transponders but the reception quality is average, the quality indication is **orange**.



Good reception quality (> 50%) → green smiley



Attention:

To identify a satellite, it must be synchronized on all 4 transponders.

However, some transponders are regularly modified.
See the frequency map of the satellite if a transponder does not seem to work.

Some switches or LNB work only with DiSEqC commands. In this case, position the OL and the polarization on DiSEqC in the Configuration page LNB-DiSEqC.
(Attention: the Check Sat is slower with DiSEqC commands).

8.4 Checking the aligned satellite

To check if you have aimed the right satellite, press the NIT key.

The appliance searches the MPEG NIT table on one of the 4 transponders and displays the name of the satellite:





Attention: The displayed name depends on the content of the MPEG NIT table. Some distributors provide no (or poor) such table. The displayed information may be wrong.

8.5 Double Check Sat

This mode allows you to orientate a double LNB by checking 4 transponders on 2 selected satellites.

A dual LNB consists of 2 single LNB, plus a built-in DISEQC switch.

For example, a dual LNB ASTRA 19-E / HOT BIRD 13-E has 2 single LNB staggered from 19-16 = 3 degrees, plus a DISEQC switch with ASTRA on PosA and HOTBIRD on PosB.

The operation is the same as simple pointing mode:

- plug
- power LNB
- pointing

To access the double Check Sat mode, you have to trigger the Double key.

Sat. A

Sat. B

To return to the simple mode

8.5.1 Recall

Azimut

Position of the satellite dish on the horizontal plane with reference to the north. Measured in degrees.



Elevation

Tilt angle under which the beam from the satellite reaches your antenna. Measured in degrees using what is specified on the stand of the satellite dish.

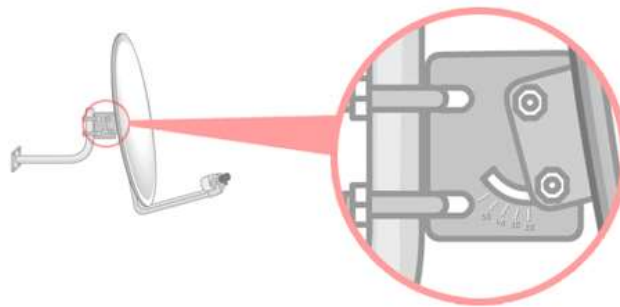

Polarization

Rotation required for the LNB from a vertical line. Measured in degrees.

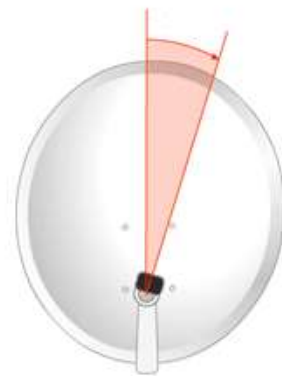

9 TERRESTRIAL check

To access to the menu terrestrial check from Home page, press 

9.1 Functioning

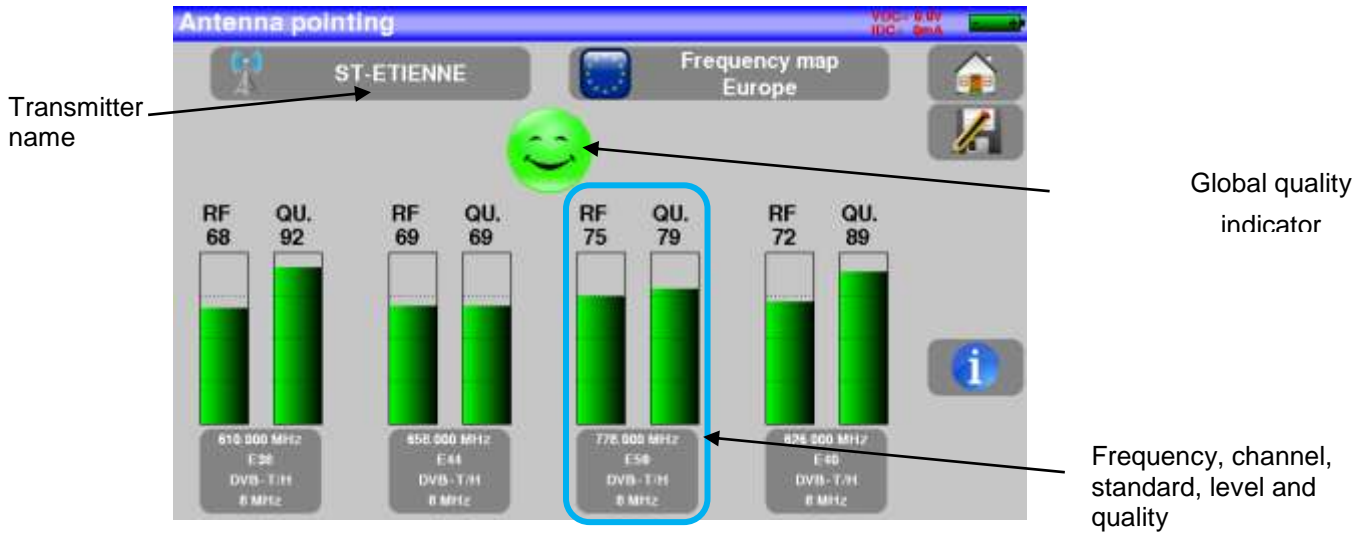

The device has a list of 10 possible transmitters.
 The device comes with a few informed transmitters.
 Each transmitter is associated with 4 channels.

The device successively scans these four channels and gives an RF indication corresponding to the level of the signal received on the antenna and QUALITY corresponding to the quality of the signal received on the antenna.

The choice of issuer is made by selecting it from the pre-informed list: (example ST ETIENNE)

To change a channel, you have to press the button on that channel :

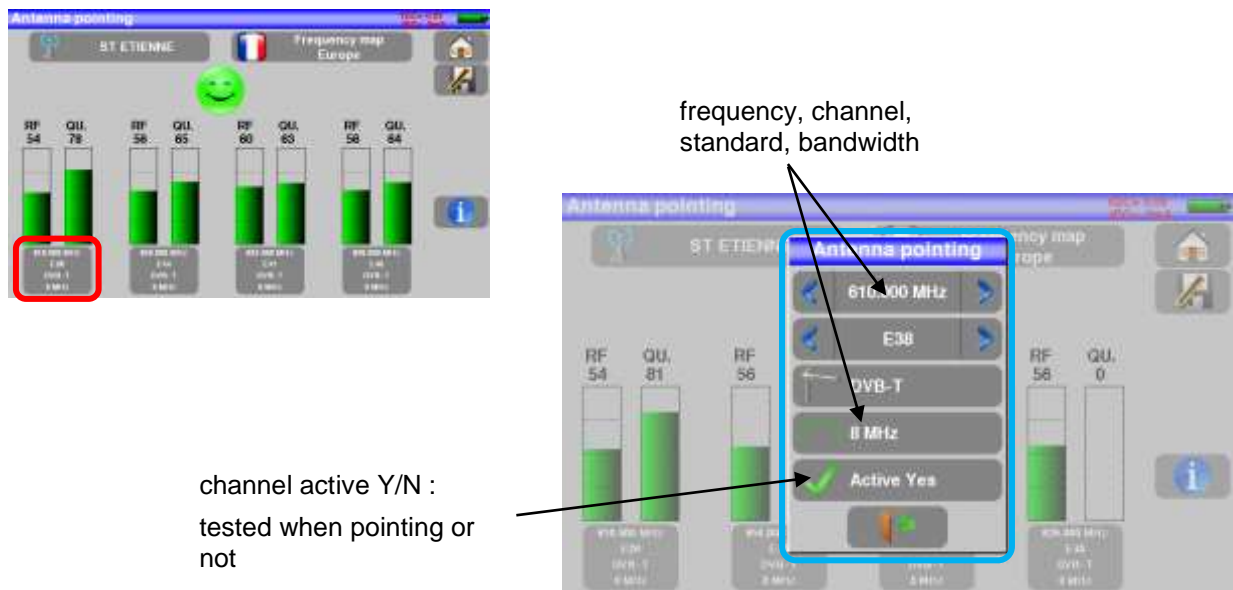

9.2 Transmitter update

You can update the frequencies/names of transmitters :
manually on your device
or
by importing the configuration from the TER file. Csv

All you have to do is to copy this file on a USB stick and go to « Configuration » then « Import »

9.3 Instruction for use

1/ Connect the antenna to the device and turn it on.

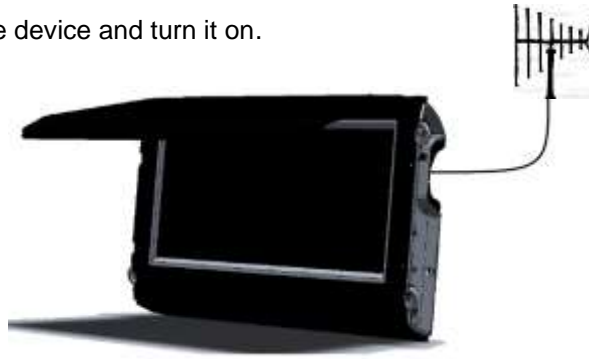

2/ on the Home page, switch to pointing mode.

Choose which transmitter to point to in the list (example STETIENNE)



3/ Slowly steer the antenna to the maximum level and hear the locking melody.

A melody is audible as soon as the first channel is found and then beeps are audible.

These beeps are getting closer and closer as the quality increases.



If the device is not synchronized across all four channels, the quality indicator is red.



If the device is synchronized across four channels and the reception quality is average, it is orange.



If the device is synchronized across four channels and the reception quality is good, it is green.



9.4 Vérification de l'émetteur pointé

To check if the pointed transmitter is the right one: press the button 

The device then searches for the TV channels of each channel and displays them instead of settings.

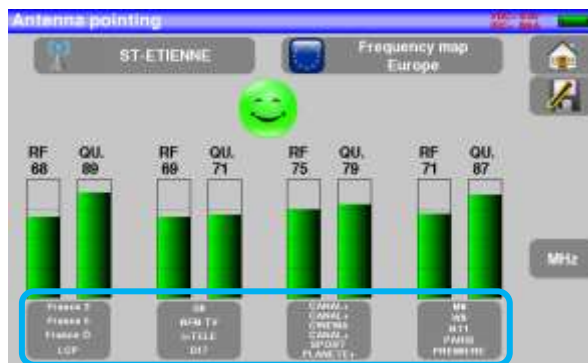

You can find the numbers of transponders of different French transmitters on the website : <https://www.matnt.tdf.fr/>

10 AUTOSET mode

This mode allows an **automatic research of setups** and to provide information about the current place. You can access it through the key  Autoset on page Home.



Attention: The Autoset channel research is only possible when at least one list is empty with enough place in the library

The displayed lines on this page depend on the selected **Frequency band**. The key before the Mode line allows you to select between terrestrial, cable or satellite mode:

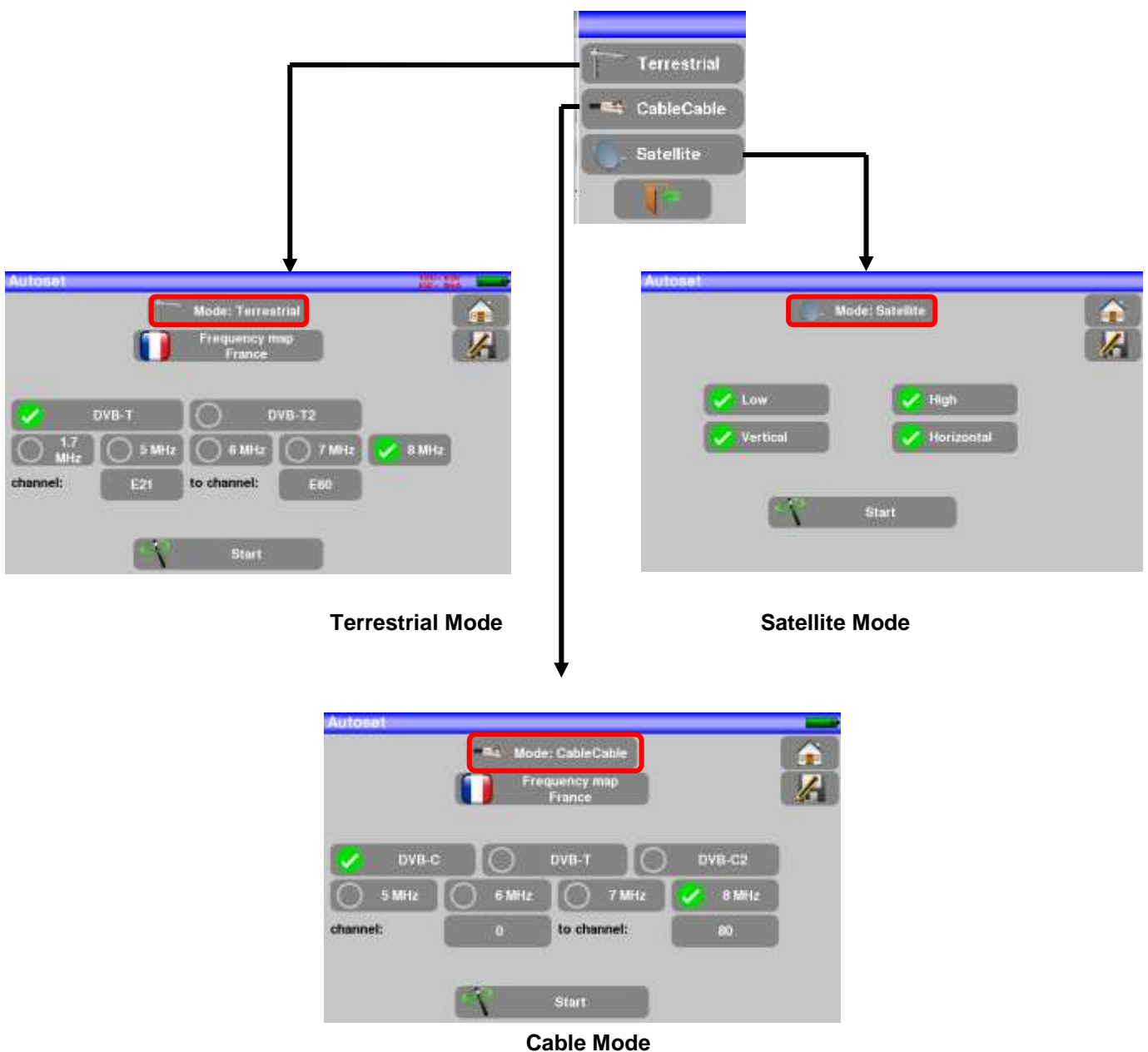

Once the mode selected, the keys of the various parameters activate or deactivate each option.

A green check shows that the parameter is included in the research. If there is no green check, the parameter will not be taken into account for the research.

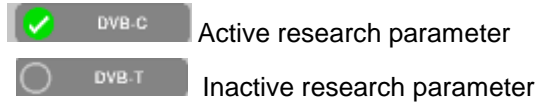

Attention: The more you select options, the longer is the research.

10.1 Terrestrial mode

This mode allows automatic research on the **terrestrial** frequency band.

The table allows the selection of:

- Standards
- Channel widths
- The channel range of the research (i.e. 21 to 60).

The goal is to make researches shorter by defining at best the settings
(example: in France, DVB-T, 8MHz, channels 21 to 60)



10.2 Satellite mode

This mode allows automatic research on the **satellite** frequency band.

The table allows the selection of:

- LNB bands
- LNB polarisations.

The goal is to make researches shorter again



10.3 Cable Mode

This mode allows automatic research on the **cable** frequency band.

The table allows the selection of:

- Standards
- Channel widths
- The search range of channels



10.4 «START » menu key

No matter which mode is selected, press the “**START**” key to launch the research.

Pressing “**Stop**” will abort the research.

When the research is done or if the user aborted it, the appliance turns automatically to the **Measurement map** function.



Any detected channel will be registered into the first empty list (automatically renamed **AUTOSET**) and into the first available setups of the library, starting from the end of the table.

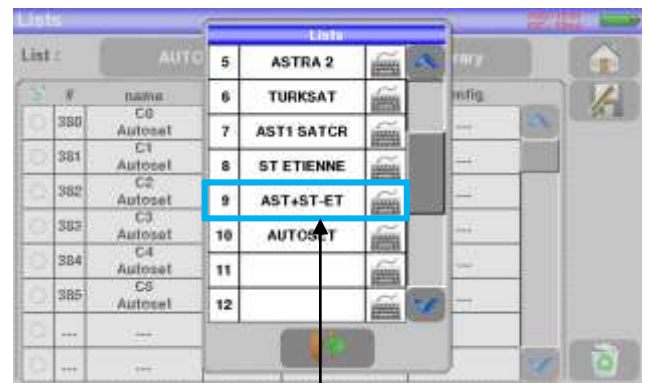
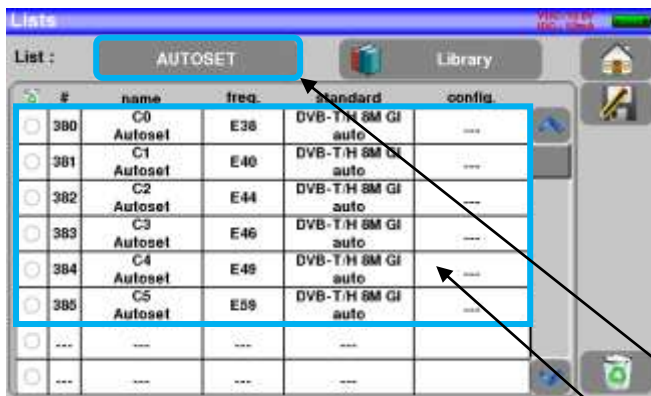

The new list is created in the first available list

The default name of the new list is **AUTOSET**

New found channels are added one by one into the new list

New found channels are added one by one into the first available setups of the library, starting from the end of the table

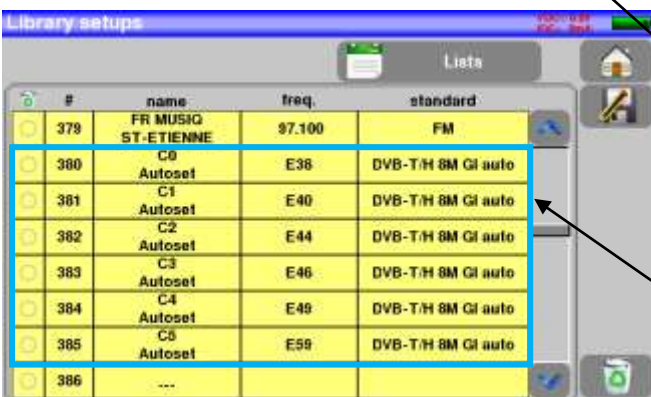

11 Measures

Pressing the MEASURE zone gives access to the **MEASURES** function.

In this page, you can either perform measurements :

- by inputting signal parameters
- on a memorized program in the current list (see chapter « Measurement list »)
- use the “ AutoLock “ function if you don't know the parameters of the signal you receive

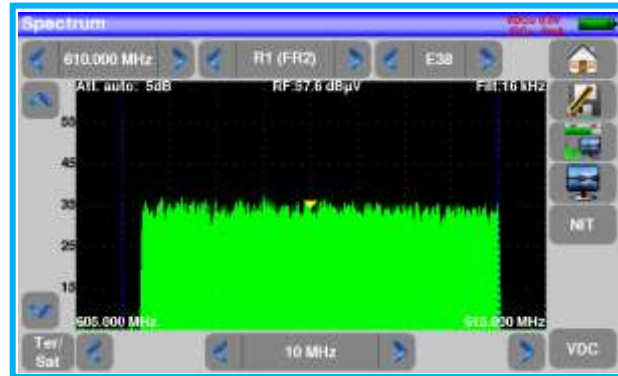

SPECTRUM
mode full
screen

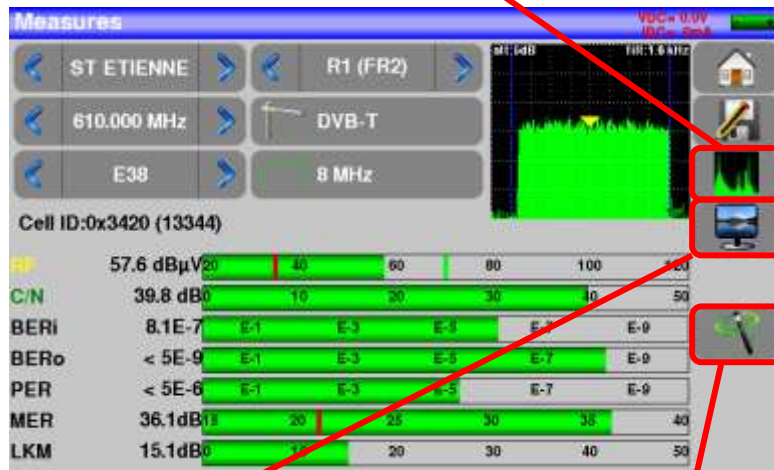

TV
mode



Autolock :
Automatic search of setup



You can shift from terrestrial to satellite mode by:

- Changing the setup frequency
- Changing of standard
- Changing of setup (from a terrestrial to a satellite setup)

11.1 Modification of parameters

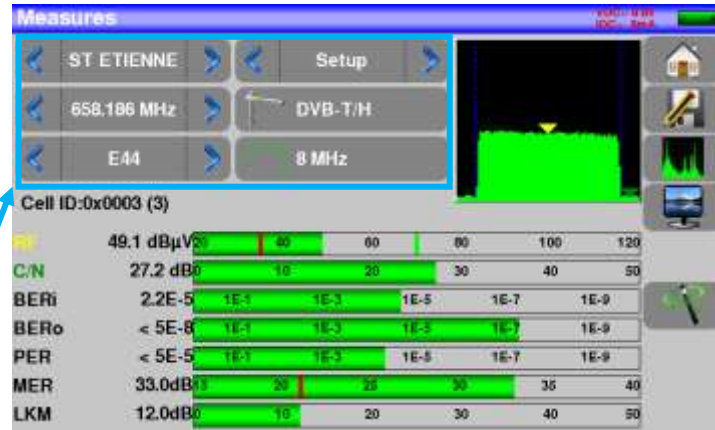

The various parameters are:

- The name of the setup (selection on the active list)
- The frequency of the emitter or transponder (and the true frequency of satellite)
- The standard and bandwidth for DVB-T/H and DVB-T2
- The corresponding channel number for terrestrial and cable mode
- The symbol rate for the satellite
- The polarization and the band for the satellite
- The audio mode for the analogical TV

11.2 Utilisation de la Liste de mesure



Vous retrouvez:

- La 'Liste de mesure' en cours que vous voulez utiliser
- Le Programme en cours dans cette liste

Dans un Programme, tous les paramètres du signal sont renseignés dans « Listes-Bibliothèque ». Ils sont automatiquement rappelés lors du choix dans la liste.

11.3 Autolock function

This function is design to lock on a digital signal (terrestrial, cable or satellite)



You just have to enter the frequency or the channel (for terrestrial), then press AutoLock, The instrument will find automatically in few seconds the digital standard, the modulation type and all other parameters of the signal.

Example for terrestrial, channel 38 (frequency 610MHz):



11.4 Level measurements

You can measure levels at a specific frequency with a detection matching the standard.

	<p>In terrestrial band, for an user socket, the level should be:</p> <ul style="list-style-type: none"> - between 50 and 66 dBμV under FM - between 35 and 70 dBμV under DVB-T/H, DVB-T2 - between 57 and 74 dBμV in any other case
	<p>In satellite band, for an user socket, the level should be:</p> <ul style="list-style-type: none"> - between 47 and 77 dBμV.

Example in terrestrial mode:



The appliance makes different measurements according to the current **standard**.

The other possible measurements are:

- **Average** measurement
- **Peak** measurement
- **Power** measurement.

11.4.1 Satellite band

The following table sums up the measurement types and the frequencies of the audio carrier waves for each standard:

Standard	porteuse vidéo	mesure
PAL	FM	Peak
SECAM	FM	Peak
NTSC	FM	Peak
DVB-S	Digital	Power
DSS	Digital	Power
DVB-S2	Digital	Power

11.4.2 Terrestrial band

The appliance automatically makes level measurements on the **Video carrier wave**.

The following table sums up the measurement types and the frequencies of the audio carrier waves for each standard:

Standard	Video carrier	Measure	Sound carrier		
			Mono	stéréo	NICAM
BG	negative, AM	peak	FM 5.5 MHz	FM 5.74 MHz	DQPSK 5.85 MHz
DK	negative, AM	peak	FM 6.5 MHz	FM 6.258 MHz	DQPSK 5.85 MHz
I	positive, AM	peak	FM 6.0 MHz		DQPSK 6.552 MHz
L	positive, AM	peak	AM 6.5 MHz		DQPSK 5.85 MHz
MN	negative, AM	peak	FM 4.5 MHz	FM 4.72 MHz	
DVB-C	digital	power			
DVB-T/H	digital	power			
DVB-T2	digital	power			
DAB/DAB+	numérique	power			
FM	FM	average			
Carrier	not modulated	average			

The appliance displays the level of the **Video** carrier wave and the **C/N** ratio.

11.4.3 Thresholds

Predefined thresholds are used to assess if the measurement is pertinent.

Standard	Min	Max
Terrestrial analog TV	57	74
DVB-C/C2	57	74
DVB-T/T2	35	70
DAB-DAB+	35	70
FM, Carrier	50	66
Satellite analog TV	47	77
DVB-S, DSS	47	77
DVB-S2	47	77

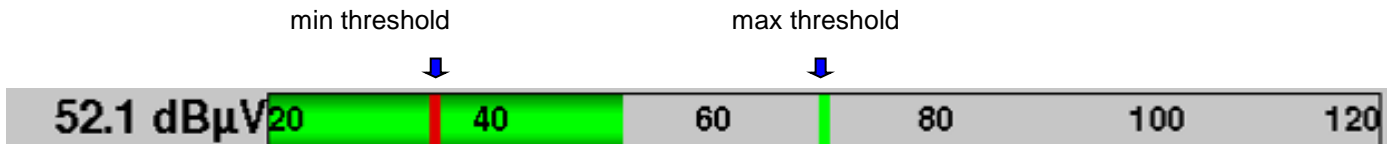



11.5 Digital measurements

In digital measurement mode, in addition to the **RF** level and to the **C/N** here above, the appliance also displays the various **BER** (Bit Error Rate), the **PER** (Packet Error Rate) and the **MER** (Modulation Error Ratio) under **DVB-T/T2/T2Lite**, **DVB-C/C2**, **DVB-S/S2** or **DSS**.

You also get the **LKM:x.xdB** (Link Margin) specification.

This expression in dB is the difference between the measured MER and the limit MER before disconnection of the image: **it's the security available before disconnection**.

	<p>“Sync ?” displayed on screen means that the signal is absent or unlocked; check its presence, the modulation parameters, the presence of remote power supply and the LNB and DiSEqC parameters under satellite band.</p>
	<p>The sign < before a value or error rate shows that there is no error but that 10^{-x} bits have been tested (i.e. $<10^{-8}$ means that 10^8 bits have been tested).</p>



You can shift from terrestrial to satellite mode by:

- Changing the setup frequency
- Changing of standard
- Changing of setup (from a terrestrial to a satellite setup)

11.6 DVB-T

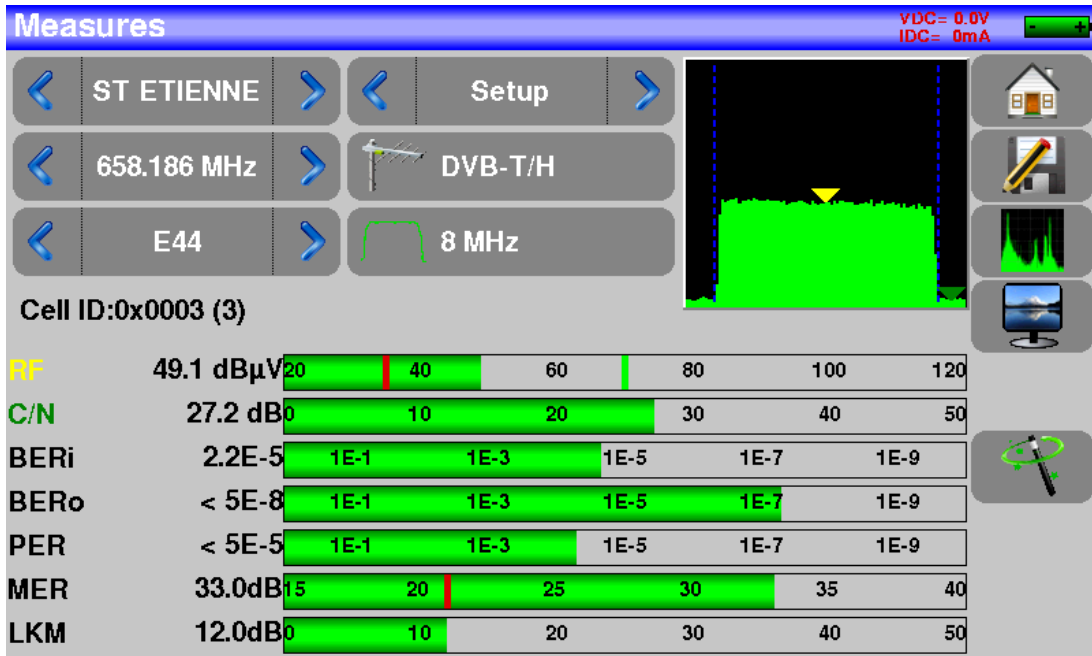
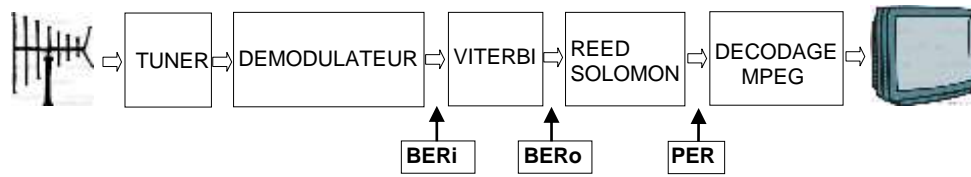

Display of the measures of:

- **BERi**: error rate before Viterbi
- **BERo**: error rate after Viterbi
- **PER**: error rate after Reed Solomon (error rate packet)
- **MER**: modulation error rate
- **LKM**: noise margin (Link Margin)

BERx: 'bits' error rate

Ratio between the number of false bits / number of transmitted bits during the measurement time

PER: 'paquets' error rate

Ratio between the number of false packets / number of transmitted packets during the measurement time

Recall: Under DVB-T/H, a packet is made of 204 octets; a packet is "false" if it includes more than 8 wrong octets (correction by Reed Solomon coding).

Display of the value of Cell ID from the diffuser and specific to the emitter.

11.7 DVB-T2 /T2 Lite

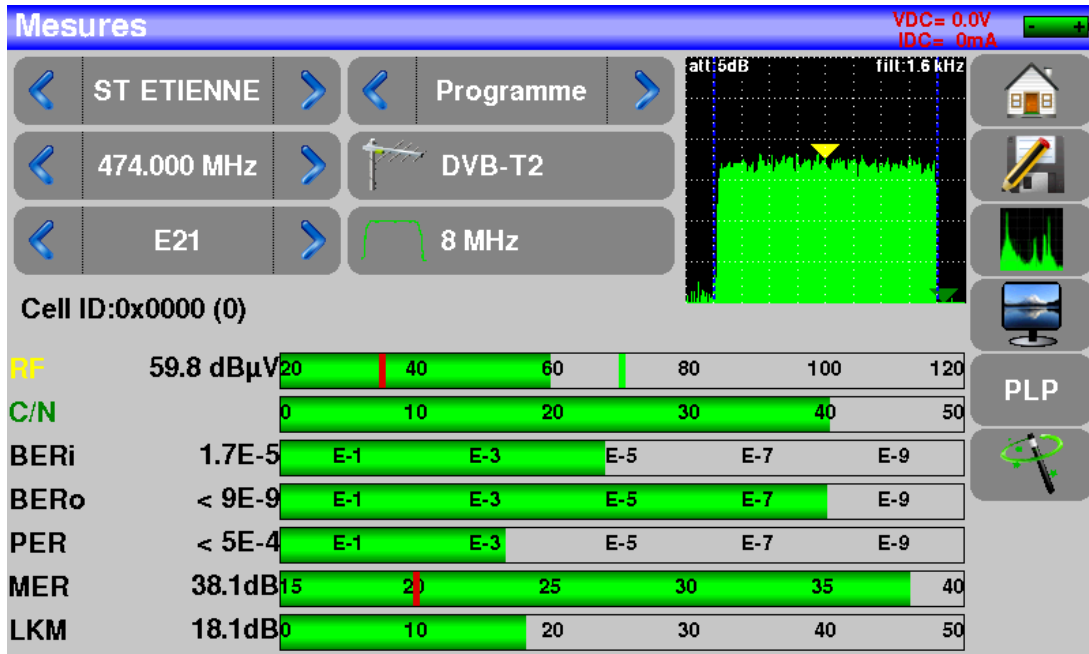
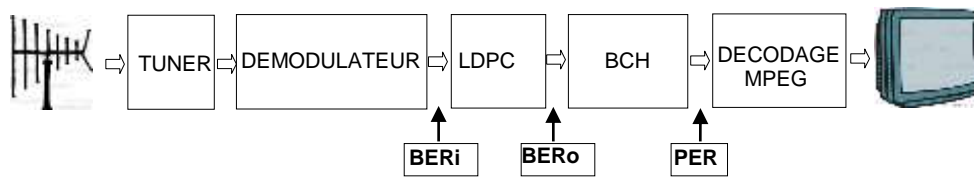

Display of the measures of:

- **BERi**: error rate before LDPC
- **BERo**: error rate after LDPC
- **PER**: error rate after BCH (lost packets)
- **MER**: modulation error rate
- **LKM**: noise margin (Link Margin)

Recall:

LDPC: Low Density Parity Check

BCH: Bose Chauhuri Houquenohe

The concatenation Viterbi + Reed Solomon of the correction of DVB-T/H has been replaced by the concatenation LDPC + BCH under DVB-T2.

Display of the values of Cell_ID from the diffuser and specific to the emitter.

11.8 DVB-C

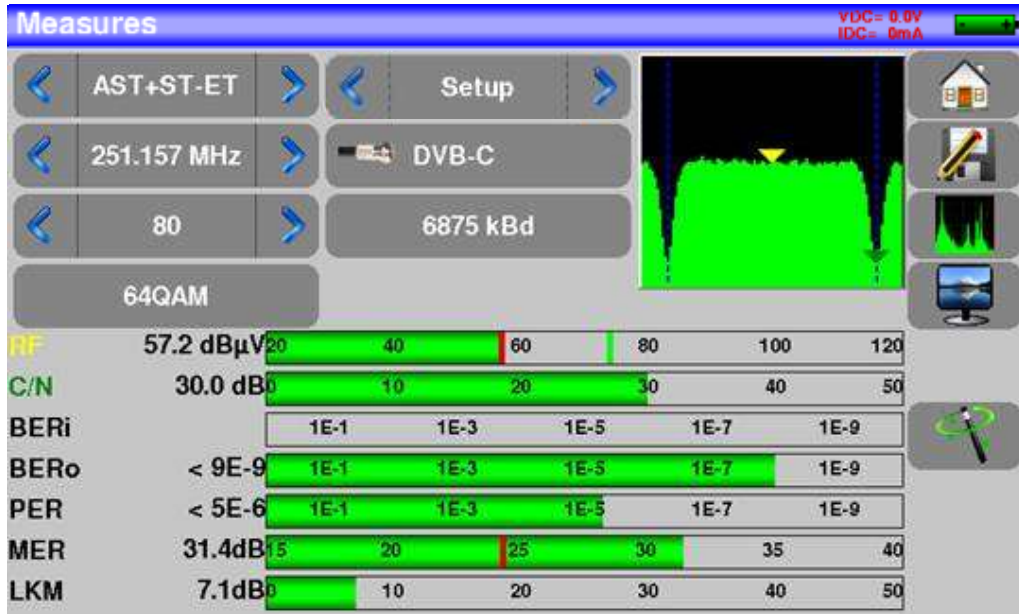
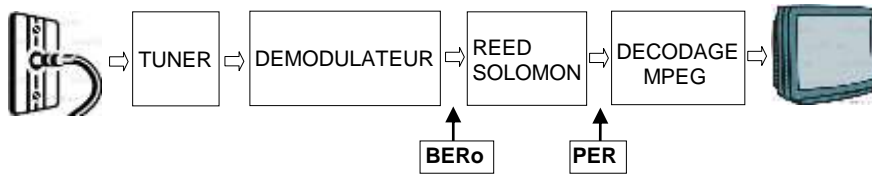

Display of the measures of:

- **BERo**: error rate before Reed Solomon
- **PER**: error rate after Reed Solomon (error rate packet)
- **MER**: modulation error rate
- **LKM**: Noise margin (Link Margin)

BERo: error rate 'bits'

Ratio between the number of false bits / number of transmitted bits during the measurement time

PER: error rate 'packets'

Ratio between the number of false packets / number of transmitted packets during the measurement time

Recall: Under DVB-C, a packet is made of 204 bites; a packet is "false" if it includes more than 8 wrong octets (correction by Reed Solomon coding).

11.9 DVB-C2

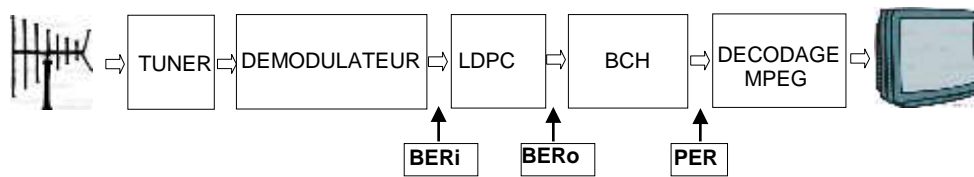

Display of the measures of:

- **BERi:** error rate before LDPC
- **BERo:** error rate after LDPC
- **PER:** error rate after BCH (lost packets)
- **MER:** modulation error rate
- **LKM:** noise margin (Link Margin)

Recall:

LDPC: Low Density Parity Check

BCH: Bose Chauhuri Houquenohe

- **Active PLP and Data slice**

11.10 DVB-S / DSS

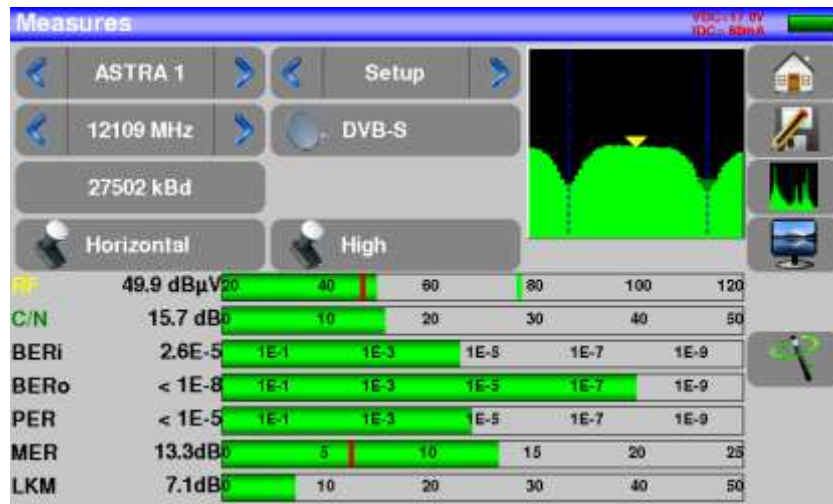
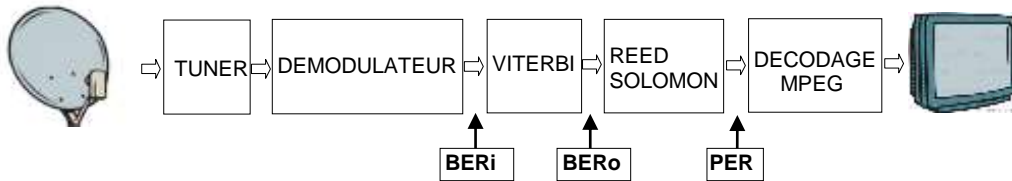

Display of the measures of:

- **BERi** : error rate before Viterbi
- **BERo** : error rate after Viterbi
- **PER** : error rate after Reed Solomon (error rate paquet)
- **MER** : modulation error rate
- **LKM** : Noise margin (Link Margin)

BERx : error rate 'bits'

Ratio between the number of false bits / number of transmitted bits during the measurement time

PER : error rate 'paquets'

Ratio between the number of false packets / number of transmitted packets during the measurement time

Recall: Under QPSK (DVB-S) a packet is made of 204 octets; a packet is "false" if it includes more than 8 wrong octets (correction by Reed Solomon coding). Under DSS, a packet is made of 146 octets.

11.11 DVB-S2 / S2X

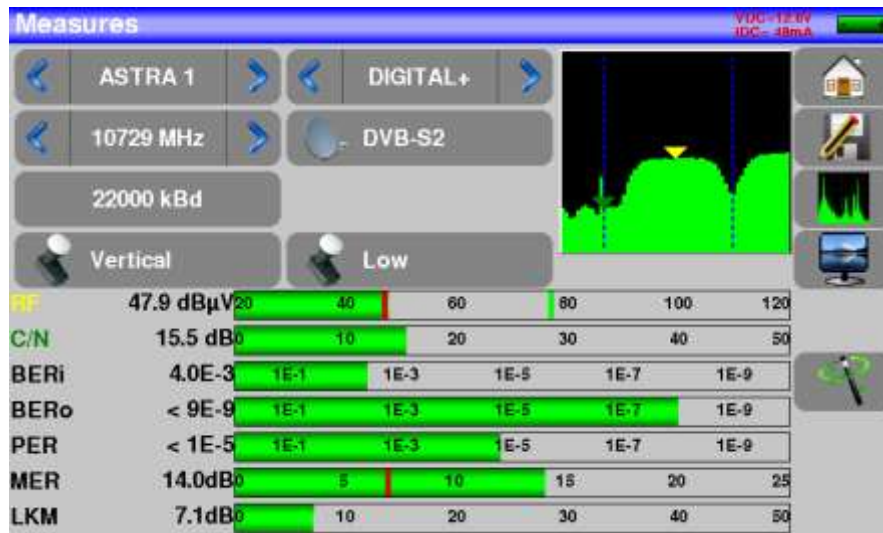
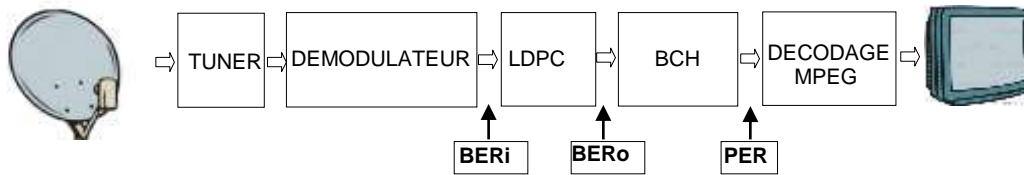

Display of the measures of:

- **BERi** : error rate before LDPC
- **BERo** : error rate after LDPC
- **PER** : error rate after BCH (lost packets)
- **MER** : modulation error rate
- **LKM** : Noise margin (Link Margin)

Recall:

LDPC: Low Density Parity Check

BCH: Bose Chauhuri Houquenohem

The concatenation Viterbi + Reed Solomon of the correction of DVB-S has been replaced by the concatenation LDPC + BCH under DVB-S2.

The standard DVB-S2 has an extension: DVB-S2X with more modulations, roll-off, ... (EN 302307 part 2)
If the option is present, the device will automatically detect this extension.

11.12 Multistream

The 'Multistream' option allows you to view a DVB-S2 signal that uses Multiple Transport Stream technology (several multiplexes are transported on the same transponder simultaneously).

Example: broadcasting of the two multiplexes of the TNT on **Eutelsat 5 West A 5°W** inside the same transponder

Frequency: 12648MHz Vertical, DVB-S2 29500, ISI: 1, Gold code: 121212

To turn ON the Multistream, press "MIS":

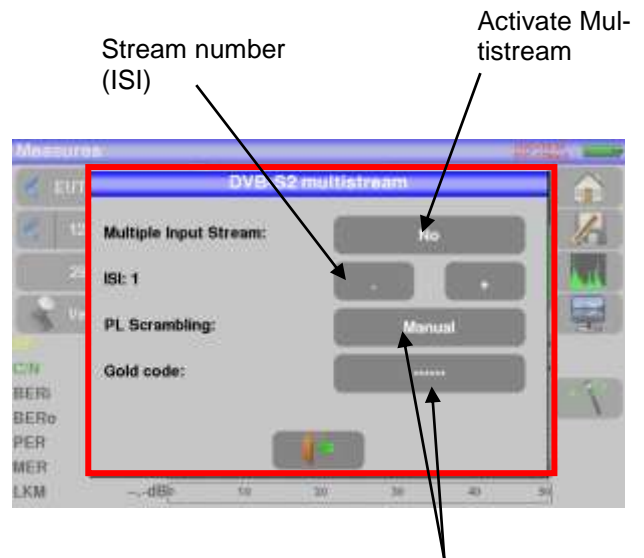

Proprietary stream coding: PL Scrambling
 - NO: no coding
 - MANUAL: a code to enter



12 Spectrum analyzer

Pressing SPECTRUM gives access to the **SPECTRUM ANALYSER function**. (graphical representation frequency / amplitude of the present signals in the input of the device)

Satellite

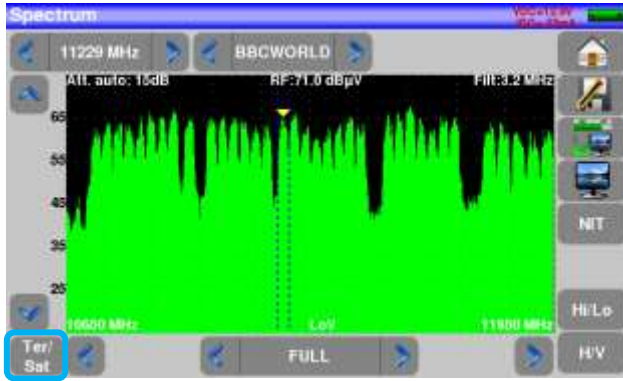

Terrestrial

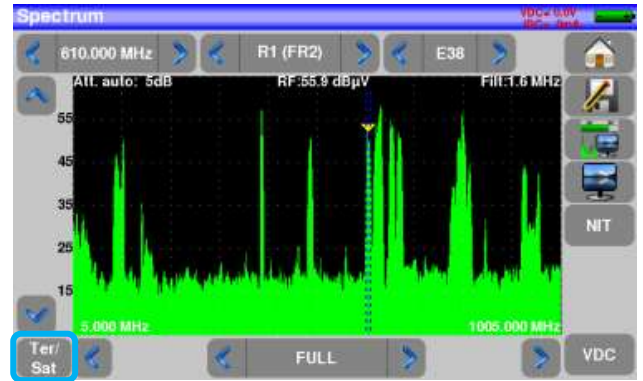

2 predefined bandwidths are available: terrestrial and satellite.

To swap from satellite to terrestrial, press the key, as shown on the bottom side of the screen.

The input attenuator is automatically tuned according to the level of the signals measured.

Filters are automatically selected according to the « Span ».

The filter used is displayed on the upper left corner.

Parameters of the spectrum are:

Frequency: value of the frequency where the cursor is, user can enter a frequency value, or increase – decrease the frequency with <> keys

Cursor: simply press the area where you want to move or set the cursor

List: you can select a Program (in the current list)

Channel: use a channel for the spectrum (in terrestrial mode).

Reference level: can be modified with up-down arrows

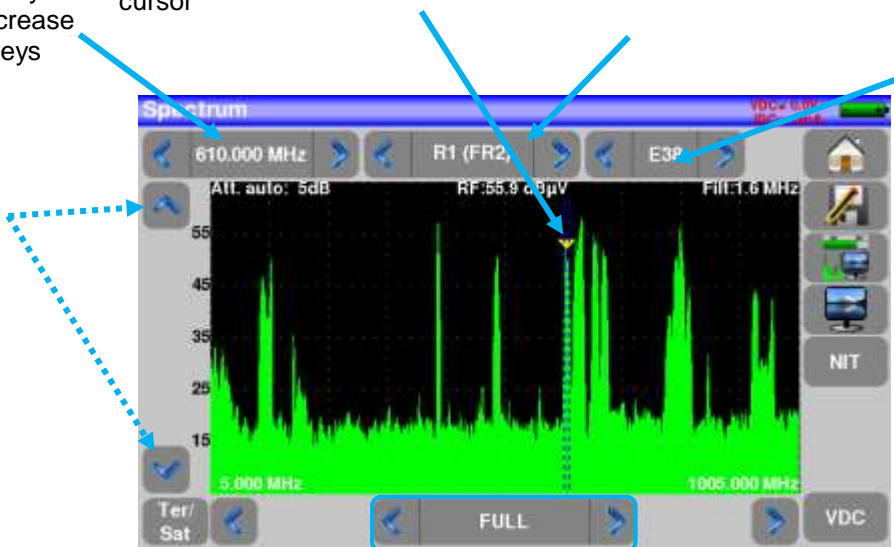

Span : frequency span around the center frequency

Frequency range: can be changed using the arrows

13 Image and Sound

Pressing the TV zone gives access to the TV function.



13.1 Digital TV

The name of the service and its main characteristics are displayed on top left of the screen.

- image resolution (e.g. HD 1920x1080i:1920 pixels per line, 1080 lines, interlaced scan)
- 25 Hz: frame frequency
- MPEG-2 or MPEG-4: picture compression
- Video Rate ex:8.628 Mbits/s : instantaneous binary rate of the service
- Audio MPEG Layer II: sound compression

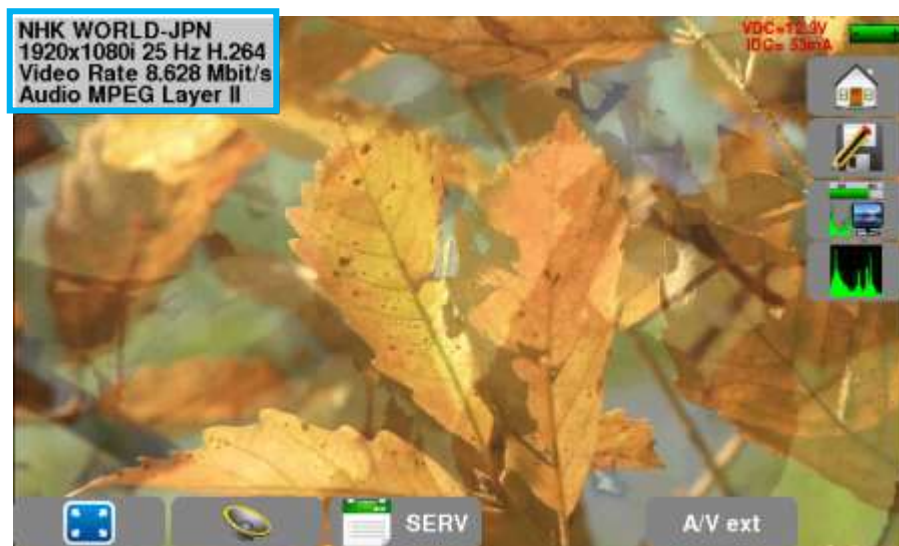

13.2 External analog video

The button  allows you to switch to analog external video

You can view the analog image PAL, SECAM or NTSC of the analog outputs of set-top boxes, cameras, video doormen ...



13.3 Audio

To set the volume, press  an adjustment bar shows up:

The instrument can decode the following digital sound formats:

MPEG-1 L1/L2

AAC Advanced Audio Coding License Via Licensing

HE-AAC High Efficiency AAC License Via Licensing

Dolby Digital License Dolby®

Dolby Digital Plus License Dolby®

Made under **licence** by **Dolby** laboratories.

Dolby and the double-D symbol are trademarks of **Dolby Laboratories**

13.4 Table of services

Pressing  gives access to the list of services:



Service list					
Service	Provider	SID	LCN	A	Type
D8	NTN	513	8		Digital TV
BFM TV	NTN	515	15		Digital TV
i>TELE	NTN	516	16		Digital TV
D17	NTN	517	17		Digital TV
Gulli	NTN	518	18		Digital TV
France 4	NTN	519	14		Digital TV

This function allows selecting the channel you want to display. You only have to press the line you want.

14 Remote power supply / LNB – DiSEqC

The  LNB-DiSEqC key gives you access to the Remote power supply / LNB-DiSEqC.

In Terrestrial, for example, you can power a line amplifier on your installation.

In Satellite, you can control all the DiSEqC equipment present on your installation.

To start the remote power supply, press the key Remote supply:

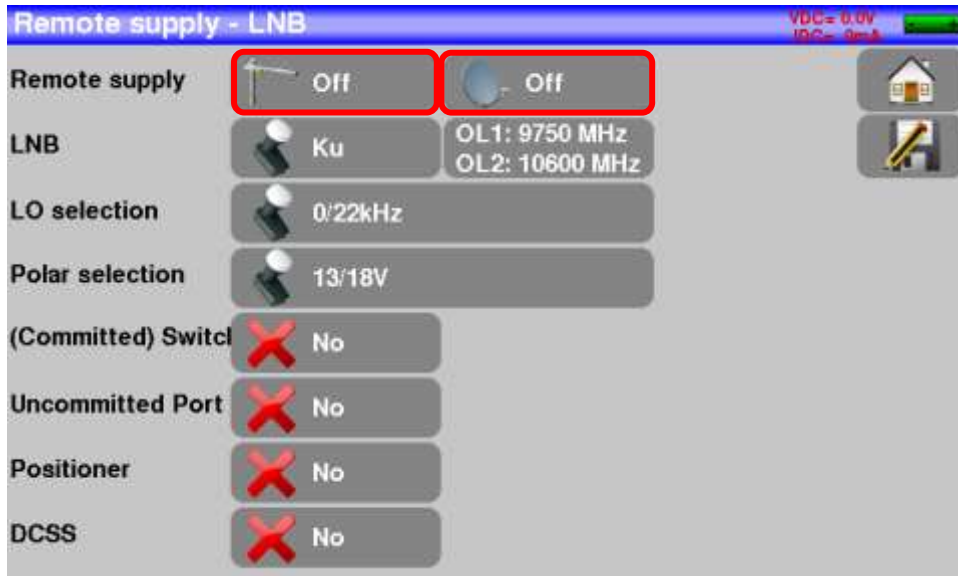

14.1 Terrestrial band

14.1.1 Power ON

In terrestrial mode, you can select:

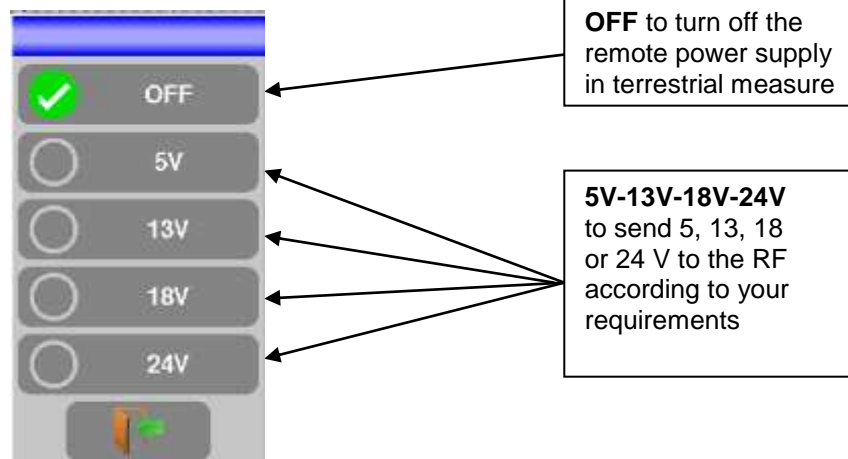

A green check shows which voltage is selected.

14.2 Satellite band

14.2.1 Power ON

Setting the remote power supply to satellite:

OFF to turn off the remote power supply under satellite measure

ON to turn on the remote power supply under satellite measure

AUTO to launch automatically the remote power supply in satellite measure mode even after shutting off

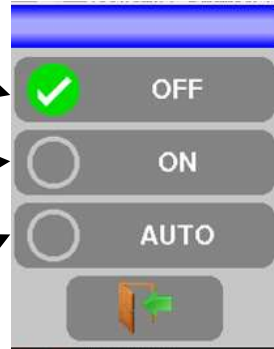

Configuration lines:

- **LNB** : LNB type and local oscillators **LO1** (low band) and **LO2** (high band)

- **LO selection**: band commutation on the LNB (22kHz, ToneBurst or DiSEqC)

- **Selection polar** : polarization commutation on the LNB (13/18V or DiSEqC)

- **Switch**: switch type and position (No, ToneBurst, 22kHz, DiSEqC, Pos A, B, C or D)

- **Uncommitted**: "Uncommitted" switch type and position (No, DiSEqC, Pos 1 to 16)

- **Positioner**: presence of a positioner (Yes / No)

- **DCSS**: Digital Channel Stacking (2 modes SATCR and SCD2 single cable distribution)

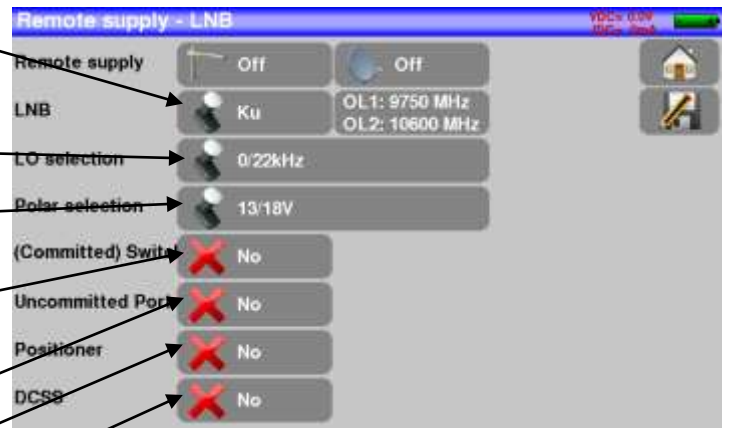

See chapter [Man-machine interface](#) for any change.

14.2.2 LNB type

You must choose the type of LNB (parable Low Noise Block head) present on your installation.



- **L band :**
 - no LNB head
 - BIS frequencies (satellite intermediate frequencies) from 200 to 2400MHz
 - no local oscillator frequency (OL)
- **C band :**
 - frequencies from 3,650 to 4,200 GHz
 - local oscillator frequency 5150MHz (OL) adjustable
- **Ku band :**
 - frequencies from 10,700 to 12,750 GHz
 - local oscillator frequency low band 9750MHz (OL1) adjustable
 - local oscillator frequency high band 10600MHz (OL2) adjustable
- **Ku wideband :**
 - frequencies entre 10,700 et 12,750 GHz
 - local oscillator frequency 10400MHz (OL) adjustable

14.2.3 Switches

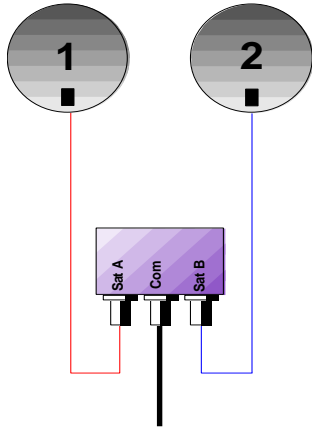

2-satellite switch

* 22 kHz

* ToneBurst (MiniDiSEqC)

*DiSEqC Committed or Uncommitted

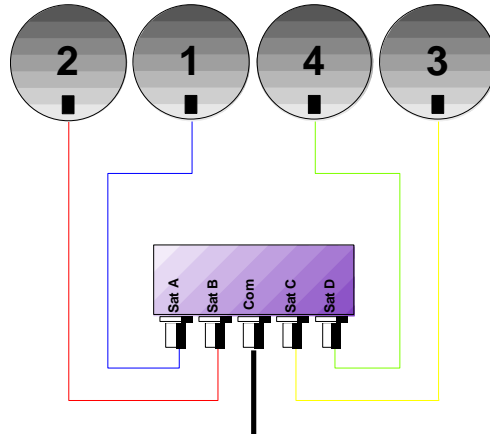

4-satellite switch

* DiSEqC Committed or Uncommitted

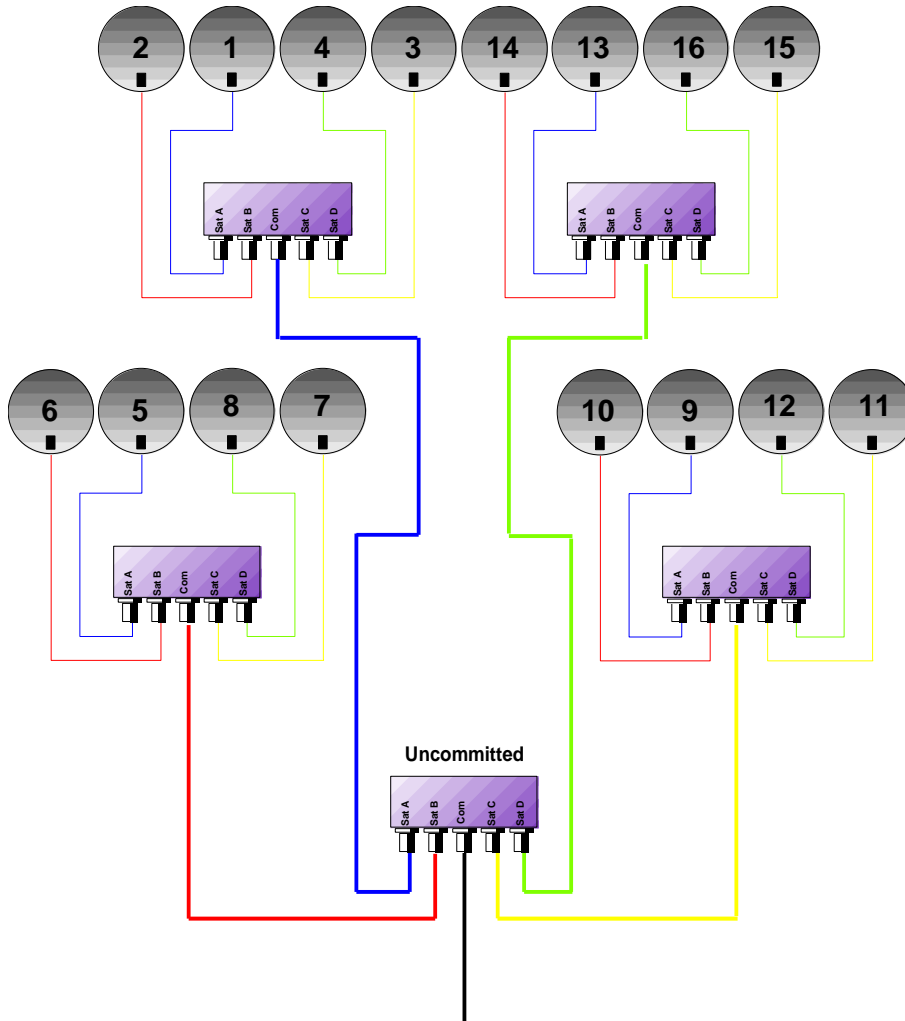

16-satellites switch

* DiSEqC Committed + Uncommitted

Satellite	Switch line		Uncommitted line	
	Position	Commande DiSEqC	Position	Commande DiSEqC
1	Pos A	Option A + Position A	Pos 1	Input 1
2	Pos B	Option A + Position B	Pos 1	Input 1
3	Pos C	Option B + Position A	Pos 1	Input 1
4	Pos D	Option B + Position B	Pos 1	Input 1
5	Pos A	Option A + Position A	Pos 2	Input 2
6	Pos B	Option A + Position B	Pos 2	Input 2
7	Pos C	Option B + Position A	Pos 2	Input 2
8	Pos D	Option B + Position B	Pos 2	Input 2
9	Pos A	Option A + Position A	Pos 3	Input 3
10	Pos B	Option A + Position B	Pos 3	Input 3
11	Pos C	Option B + Position A	Pos 3	Input 3
12	Pos D	Option B + Position B	Pos 3	Input 3
13	Pos A	Option A + Position A	Pos 4	Input 4
14	Pos B	Option A + Position B	Pos 4	Input 4
15	Pos C	Option B + Position A	Pos 4	Input 4
16	Pos D	Option B + Position B	Pos 4	Input 4

14.2.4 Motorized Satellite dish control

The appliance sends a DiSEqC command that triggers the rotation of a motorized satellite dish.

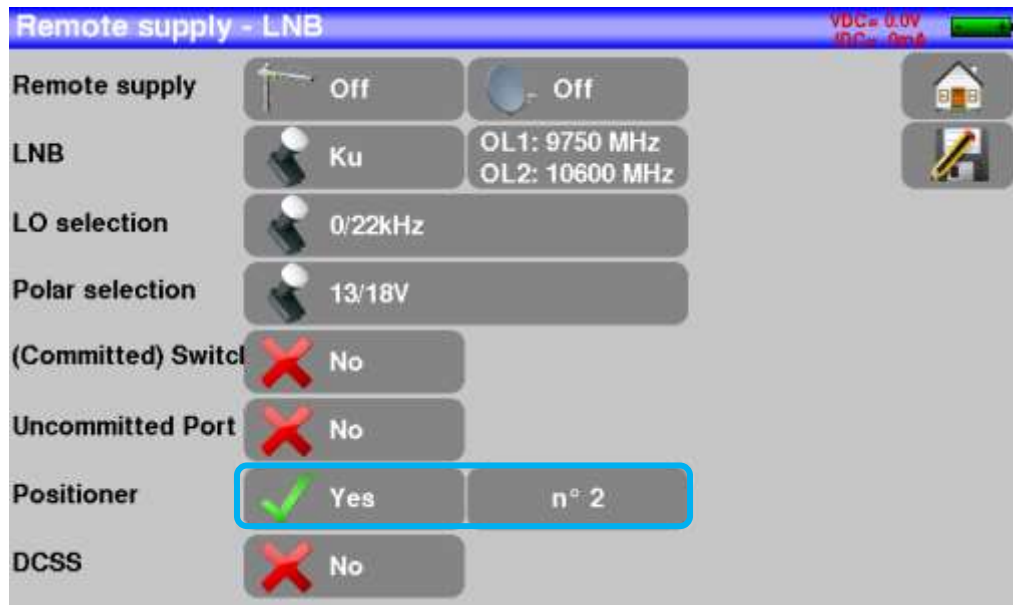

In this example, the position is 2 (1 to 127 pre-loaded positions in the positioner)

If the positioner is on No, it is deactivated

See chapter [Man-machine interface](#) for any change.

14.2.5 DCSS

Description:

DCSS Digital Channel Stacking system: signal distribution system using frequency transposition.

Used in satellite distribution for multiple or single dwelling, with several set top boxes.

To give several receptors access to the whole spectrum and all polarizations, you need **one coaxial cable per receptor** and a suitable installation (multiple LNB, Quattro and multi-switches).

The **DCSS system** allow to feed dwellings with one or more satellites using only one coaxial cable (**SCD=SINGLE CABLE DISTRIBUTION**).

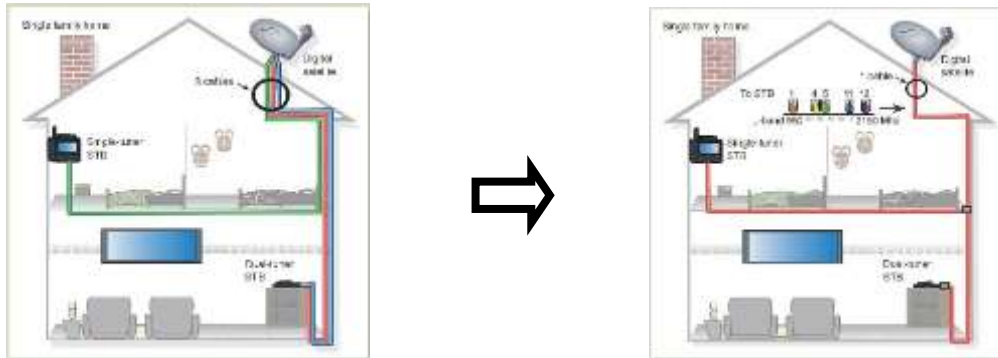

The DCSS is an extension of the DiSEqC protocol that allows the connection of several receptors on **only one coaxial cable**, no matter the band (H/L) and the polarization (H/V).

Functioning:

Each satellite receptor uses a fix frequency band (**Slot** or **Port**), whose width is (more or less) equal to the width of the transponder.

The receptor requires a specific transponder frequency (frequency Ku) via a DiSEqC command.

Some equipment on the satellite dish (LNB or switch) moves the requested signal to the center of the selected band (**Slot**). Then, the mixing equipment adds each user band (**Slot**) to only one output (up to 32 user bands).

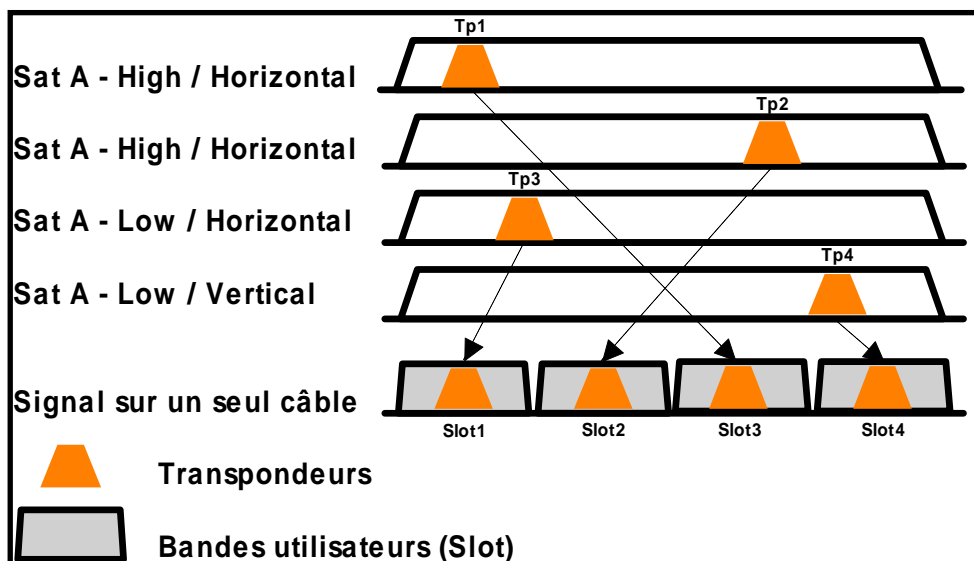

2 Modes :

SATCR : Satellite Channel Router, standard EN50494 (or SCD, Unicable, ...)

Distribution of the satellite signal with only one coaxial cable to 2, 4 or 8 different receptors.

SCD2 : Single Cable Distribution v2, standard EN50607 (or SCD2, Unicable II, JESS)

Distribution of the satellite signal with only one coaxial cable to a maximum of 32 different receptors.

Using Diseqc 2.0 bi-directional possibility to ask current online devices and speed up installation.

Mode choice: press DCSS



14.2.6 SATCR (EN50494)



- SLOT x: active Slot choice
- CONFIG: access to each slot configuration



Slots list, frequencies

- INITIALISATIONS: 8 predefined slots
- ITALY: 4 predefined slots for Italy
- DETECT: automatic detection of slots (spectrum detect based)

14.2.7 SCD2 (EN50607)



- SLOT x: active Slot choice
- CONFIG: access to each slot configuration



Slots list, frequencies, PIN codes, bandwidth

- INITIALISATIONS : 32 predefined slots
- ALLOCATION : states of the 32 possible slots
- DETECT : automatic detection of slots (DISEQC2.0 based)

14.2.8 Influence of the DCSS on the spectrum analyzer

The frequency of the cursor in spectrum remains fixed: this is the central frequency of the slot.

The frequency of the requested transponder is 'transposed' inside the slot by the DCSS equipment: it is the 'REMOTE TUNING'.

Frequency of the transponder visible at the center of the active slot

DCSS mode and active slot

Current polarization and band in the active slot

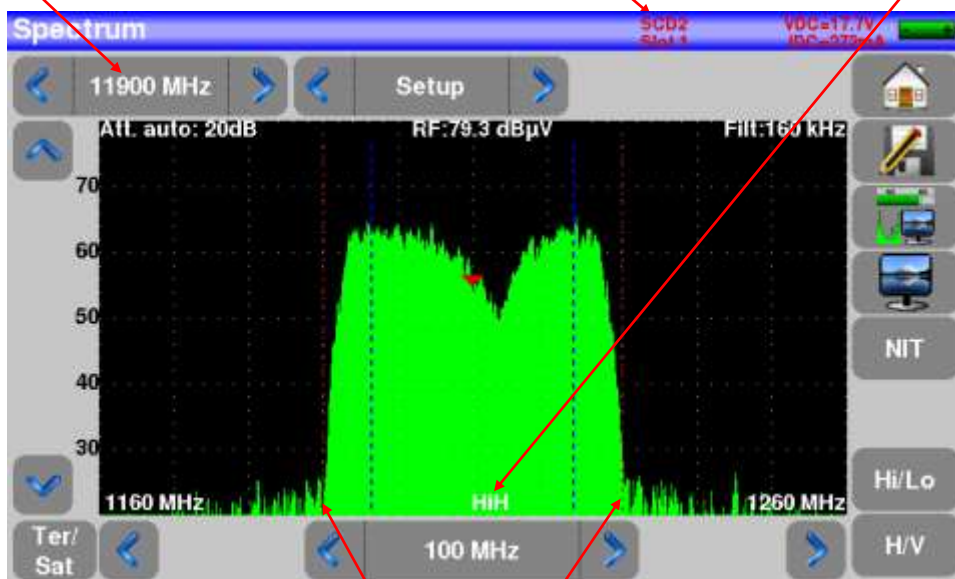

RED landmarks of the user bandwidth (slot)

15 Constellation

The  Constellation key gives you access to the **CONSTELLATION** function.

These measures are available if one of these standards is running in the **LEVEL MEASUREMENT** page.

- DVB-T/T2
- DVB-C/C2
- DVB-S/S2, DSS

The appliance displays the **Constellation** of the current signal.

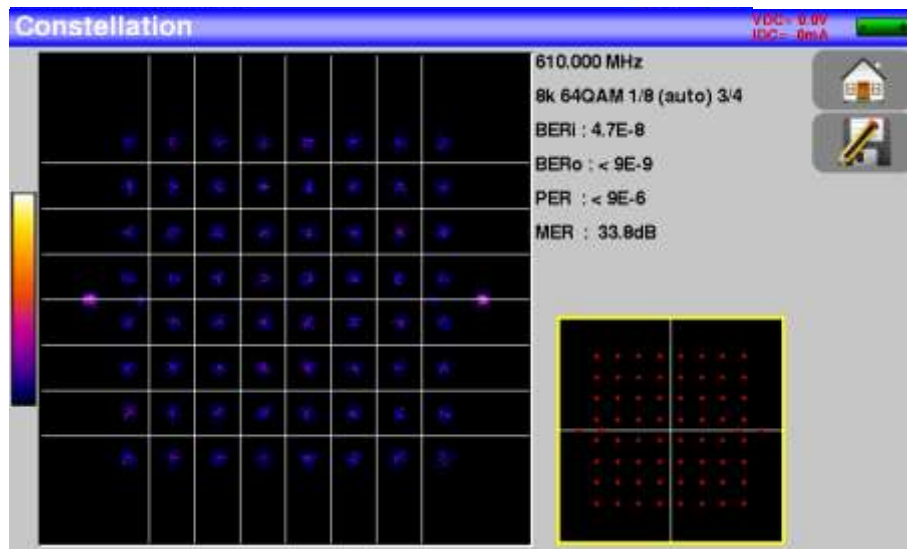

The information displayed on the right of the **Constellation diagram** is:

- current frequency
- modulation
- constellation
- symbol rate
- error rate and MER

16 Multipath / Guard interval



Available only for DVBT/T2 or DVB-C2 standards.

Pressing  allows you to access to **Multipath / Guard interval measurement**.

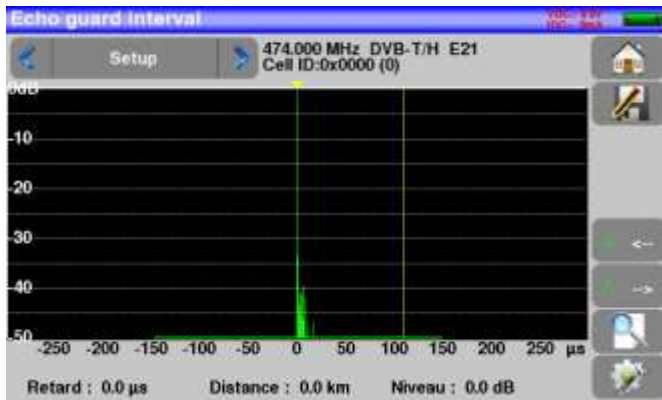

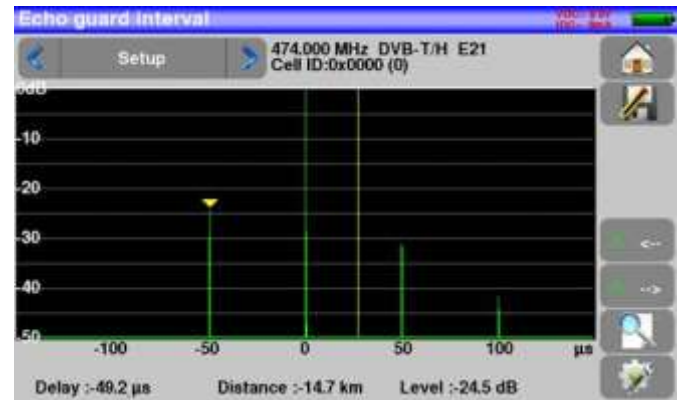

Signal without echo



Signal with echoes and pre-echoes

Pressing  changes the horizontal scale (distance).

Horizontal scale can be set in μ s, km or miles by pressing .

Moving measurement arrow  can be done by screen touch, or by automatic search keys .

and .

The end of the guard interval is displayed with a **yellow line**.

Reminder :

Remember: In terrestrial TV broadcasting, the received signal on the antenna comes from several possible ways: the **echoes**.

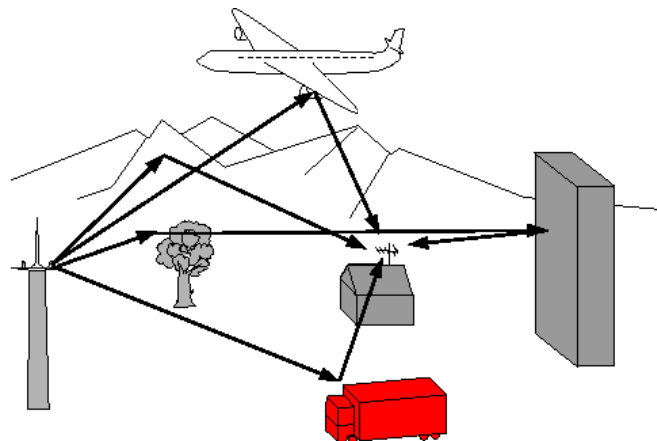

In digital TV DVB-T/T2, these echoes may help or degrade the image according to the time delay between the various signals that reach the antenna.

The broadcasting norms DVB-T and DVB-T2 define a modulation parameter called "**guard interval**" where echoes won't disturb the reception.

The transmission of digital data (**Symbol**) is interrupted during the **guard interval**.

A delayed (or advanced) symbol of any **shorter** duration than the guard interval will not disturb the reception.

A delayed (or advanced) symbol of any **longer** duration than the guard interval will disturb the reception.

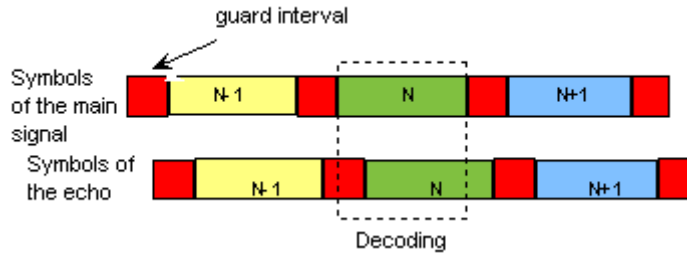

You have to reduce the level of reception of the echoes by orienting the antenna or by selecting a more directive antenna.

The **Echo** function of the appliance enables you to display possible **echoes** that disturb the received signal.

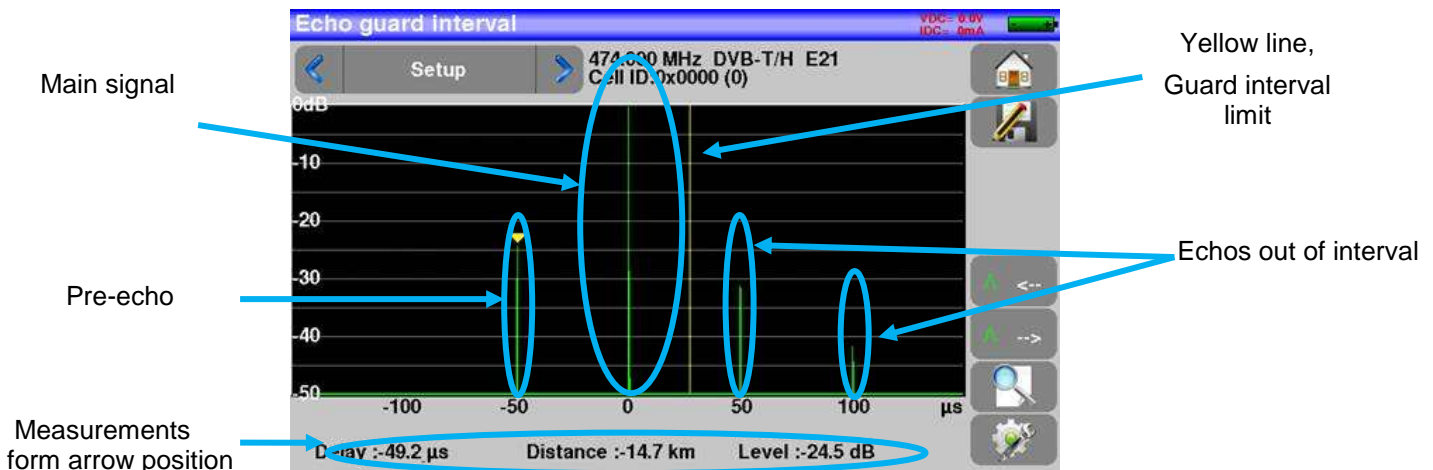

Relative amplitude in dB and delay in μs (distance in km) from the main signal (0 pulse) can be measured.

The **yellow line** represents the end of the guard interval.

Echoes and pre-echoes (pulses) above the yellow line disturb the signal and must be reduced as much as possible.

The echoes (pulses) beyond this line disturb the reception and must be as weak as possible.

	<p>Attention: a high amplitude echo pulse within the guard interval will also disturb the signal quality.</p>
---	---

17 Measurement map

To access the **MEASUREMENT MAP** function, press Home then Measurement map:



It is an automatic level and error rate measurement of the setups in the measurement list with labeling of the levels beyond tolerance.

Measurement result for channel 38 under DVB-T/H

The screenshot shows the 'Measurement map' screen for 'ST ETIENNE'. It displays a table of measurement results for various channels. The row for channel E38 is highlighted with a blue box. The table columns are: freq., std, RF, C/N, BERi, BERo, PER, and MER. The top status bar shows VDC: 0.0V and IDC: 0mA.

freq.	std	RF	C/N	BERi	BERo	PER	MER
E38	DVB-T/H	51.5	31.1	1.4E-7	<1E-8	<1E-5	33.7
E44	DVB-T/H	49.2	29.3	3.5E-5	<1E-8	<1E-5	32.9
E59	DVB-T/H	51.0	31.1	2.3E-7	<1E-8	<1E-5	33.7
E40	DVB-T/H	50.9	31.0	4.9E-6	<1E-8	<1E-5	33.1
E49	DVB-T/H	52.0	31.6	1.4E-7	<1E-8	<1E-5	33.5
E46	DVB-T/H	51.2	30.8	9.5E-8	<1E-8	<1E-5	33.8
88.000	FM	57.3	>57.3				

BERi, **BERo** and **PER** are generic terms (frequently used)



BERi = BER in = inner BER



first BER treated by the demodulator (BER channel, CBER, LDPC)

BERo = BER out = outer BER

last BER treated by the demodulator (BER Viterbi, VBER, BCH)

PER = packet error rate

uncorrected packet, lost packet, wrong packet (UNC, PER)

	<p>Important:</p> <p>A bargraph above the Measurement map allows you to track the evolution of the scan.</p> <p>The background color of this bargraph shows you that a complete scan has been made (for a save, for example):</p> <ul style="list-style-type: none"> - red: the measurement map has not been totally scanned yet green: the measurement map has been totally scanned
	<p>In case of mixed measurement map (terrestrial+satellite), the satellite remote power supply has priority (the terrestrial remote power supply is ignored).</p>

17.1 Out of tolerance values

The digital values are colored according to the **Thresholds** before decision

- **red** for values less than **Threshold min**
- **orange** for values more than **Threshold max**

Measurement map								VDC= 0.0V	IDC= 0mA
ST ETIENNE								1/9	
fréq.	std	RF	C/N	BERi	BERo	PER	MER		
E38	DVB-T/H	56.3	>22.3	8.6E-4	<5E-9	<5E-6	23.1		
E44	DVB-T/H	56.3	>22.3	9.8E-4	<5E-9	<5E-6	21.9		
E59	DVB-T/H	27.0	>13.0	Sync?	Sync?	Sync?	--		
E40	DVB-T/H	24.0	>10.0	Sync?	Sync?	Sync?	--		
E49	DVB-T/H	24.0	>10.0	Sync?	Sync?	Sync?	--		
623.812	DVB-T/H	60.6	>26.6	Sync?	Sync?	Sync?	--		
10743 HL	DVB-S	74.7	>20.4	<1E-7	<5E-9	<9E-6	15.3		

18 Optical measurement 7859B

The 7859B model has an optical fiber input dedicated to installations that use optical fiber to distribute the RF signal (RF over Fiber).

18.1 Presentation of the optic measurement

The Optic function allows measurements in various kind of installations :

- in satellite reception with fiber wiring (LNB optical fiber output)
- after a satellite / terrestrial coupler

The function :

- measures the optical power of the light carrying the signal in the fiber
- converts the light signal into an RF signal to perform the same measurements as before

Accessories are provided to use this function:

- one FC/FC optical patchcord
- one FC/SC optical patchcord
- one connection SC/SC APC
- one connection FC/FC

Plugging:

(Appliance seen from above)

*FC APC optical input
with protective plug*



To switch to optical mode:

From the start page:

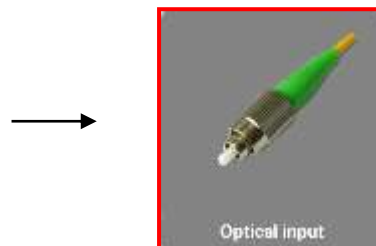

From the home page:

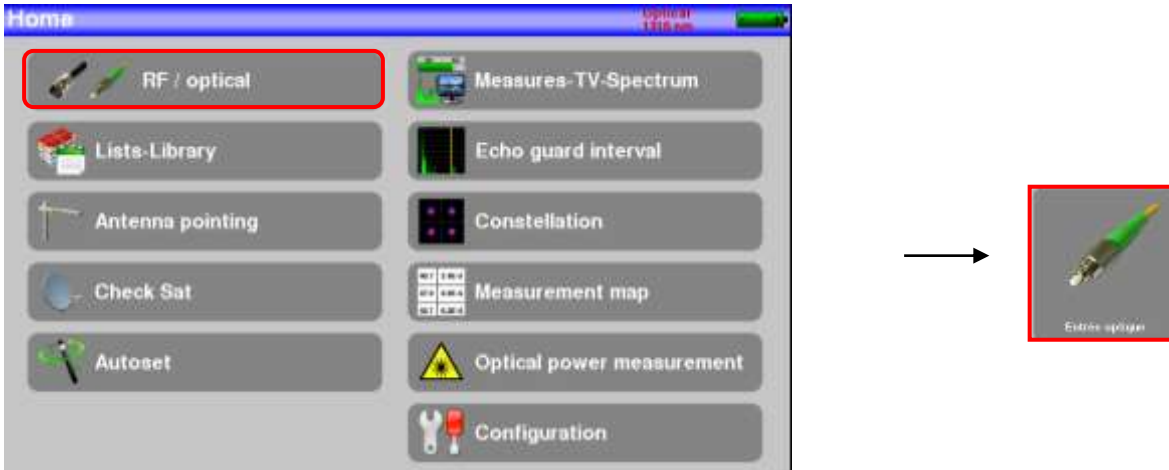

18.2 What you need to know

A few notions are required before considering the use of optical fibers.

18.2.1 The optical fiber

Optical fibers are sometimes used for satellite reception. This technology enables makes it possible to transmit a signal further with less loss and with a larger bandwidth.

The optical fiber is a waveguide, generally made of glass, that enables the transmission of the optical signal. Optical fibers are made of a core, a cladding and at least one protection. There are two kinds of optical fibers: multimode and single-mode.

The difference is the size of the core inside the fiber: $9\mu\text{m}$ diameter for single-mode, $50\mu\text{m}$ for multimode.

Multimode is less expensive, while single-mode induces less losses.

For satellite reception, only single-mode fibers are used.

Sectional view of an optical fiber:

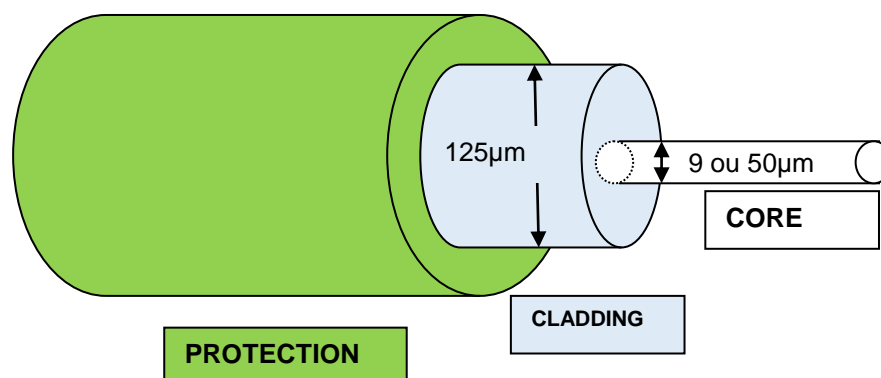

Warning: Optical fibers are fragile and must not be constrained, bent or folded: the core may be damaged or even broken, which results in a partial or total loss of the signal.

18.2.2 Connectors

Like for RF, connectors are very important and their selection has consequences on the quality of the received signal.

With optical fibers, there are several kinds of connectors according to the type of fiber (single-mode or multimode) and to the selected connection.

Thus, there are plastic SC connector for indoor uses and metal FC connectors for indoor and outdoor uses.

Similarly, there are various « polishing » of the fiber core:

- straight PC (Physical Contact) SPC (Super Physical Contact) or UPC (Ultra Physical Contact), or
- angled APC (Angled Physical Contact)

APC polishing generates advantageously less losses by reflection. APC connectors are recognizable thanks to their green color.

If you plug an APC connector to a non-APC connector, in addition to an increased risk of **damaging the connector**, there will be **automatically** a **4dB** decrease of the optical level, which means **8dB** for RF. Thus, you will have to take great care of the connections and the types of connectors for your installation.

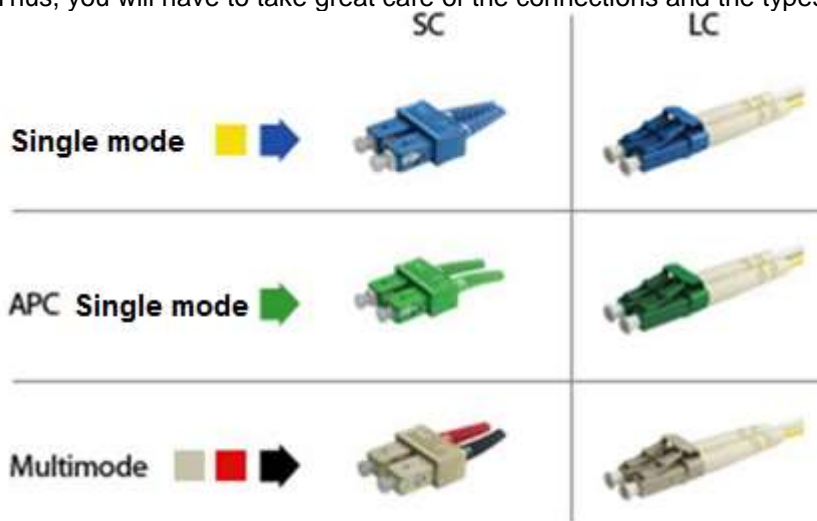



On the measurement device, the connector is **FC APC**, but **2 jumper cables** are provided with the appliance to switch from **FC APC to FC PC (UPC or SPC)** and from **FC APC to SC APC**.

	Warning: Before connecting a fiber, it is compulsory to clean both connectors with a compressed air spray. Never use clothes, alcohol, water or any other liquid or solvent.
	Warning: The wavelengths inside the optical fibers are generated by lasers; you cannot see them , but they are particularly dangerous for your eyes and may lead to irreversible damages . Thus, you must be very careful when manipulating these fibers (i.e. do not watch inside a connector when linked to the live head). The measurement device has no optical source: it does not emit any light.

18.3 Optical power measurement

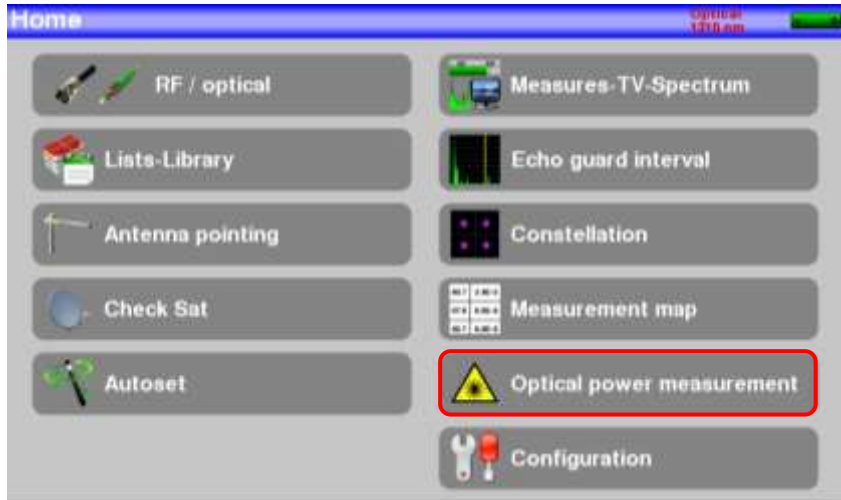
To access the Measurement of Optical Power, press the key “Optical power measurement”.





Warning: The appliance can measure only one wavelength at a time. If there are several wavelengths, measurements will be wrong.

Plug the optical fiber at the output of your equipment on to the optical FC APC socket of the appliance.

Measurement of the losses at insertion:

Make a first measurement at the LNB of your installation: press the reference of the desired wavelength. The appliance will keep this measure as a reference and automatically switches to dB. Make measurements everywhere on your installation to check losses of the optical signal.

Selection of the displayed wavelength: 1310, 1490 or 1550nm

The screenshot shows the 'Optical power measurement' interface. At the top, it says 'Optical power measurement' and 'Optical 1310 nm'. Below this, there are controls for 'Wavelength' (1310 nm, 1490 nm, 1550 nm), 'Unit' (dB, mW, dBm), and 'Reference' (-51.9 dBm). The current 'PWR:' is shown as 2.1 dB. A graph at the bottom displays 'Graphics of measure vs. time' with a vertical axis from -30 dB to 30 dB. A legend on the left indicates: Purple: 1310nm, Yellow: 1490nm, Blue: 1550nm. A legend on the right indicates recording durations: 10mn, 60mn, 8h, 24h. Annotations with arrows point to these specific elements.

18.4 The satellite reception via optical fiber

With optical fibers, the satellite emission is the same as in standard reception mode, but at the output of the head, instead of 4 bands (HH HL VH VL), there are only 2 bands (vertical and horizontal) in optical signal mode (the optical head is powered by an independent external power supply).

On your installation, at the end of the fiber, you must install a converter that turns your optical signal to a 4-band RF signal: HH HL VH VL; VL and HL bands are between 950 and 1950MHz; VH and HH bands are between 1100 and 2150MHz. Band commutations on this converter are made with 0/22kHz and 13/18V like on any classical installation.

In our case, the output of this head (fiber) may be directly connected to the appliance, which will manage the bands like the converter in order to allocate them between HH, HL, VL and VH. Thus, the use is transparent. **Warning:** the LNB is powered independently.

	<p>Warning: The appliance can measure only one wavelength at a time. If there are several wavelengths, measurements will be wrong.</p> <p>You'd better check the optical power of the LNB before processing (Measurement of optical power)</p>
---	---

To display the signal at the output of your installation, you must connect the RF output of the optical option to the RF input of the appliance via the provided angled F/F cable. Power your LNB (no external power supply is provided with the measurement appliance).

Remove the protective plug from the FC APC optical socket; if required, use the provided jumper cable, and connect the optical fiber from your dish to the same socket.

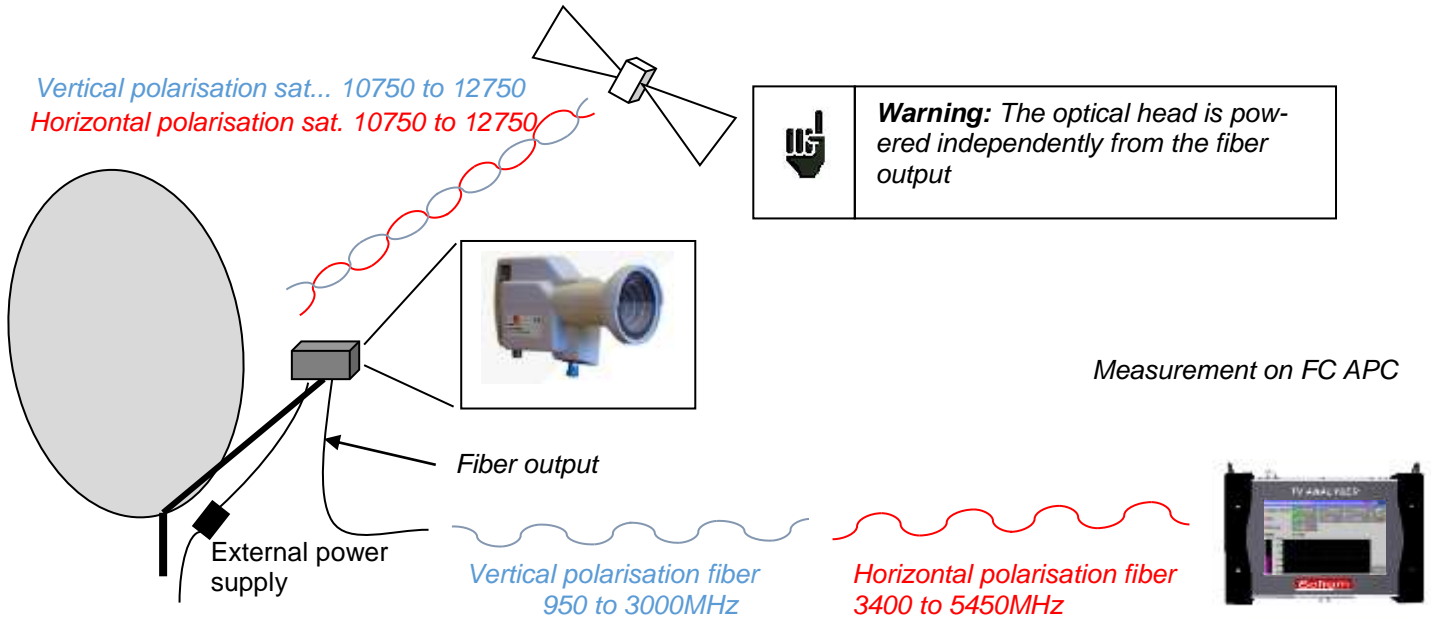

You can then use "Check Sat" function for your dish.

Once the measurements are over, **put the protective plug on to the optical socket** of the appliance.

18.5 Fiber reception after coupler

The optical option makes it possible to make measurements after terrestrial coupler / sat at the output of the fiber.



Warning: The appliance can measure only one wavelength at a time. If there are several wavelengths, measurements will be wrong.

You'd better check the optical power of the coupler before processing ([Measurement of optical power](#))

Example of installation:

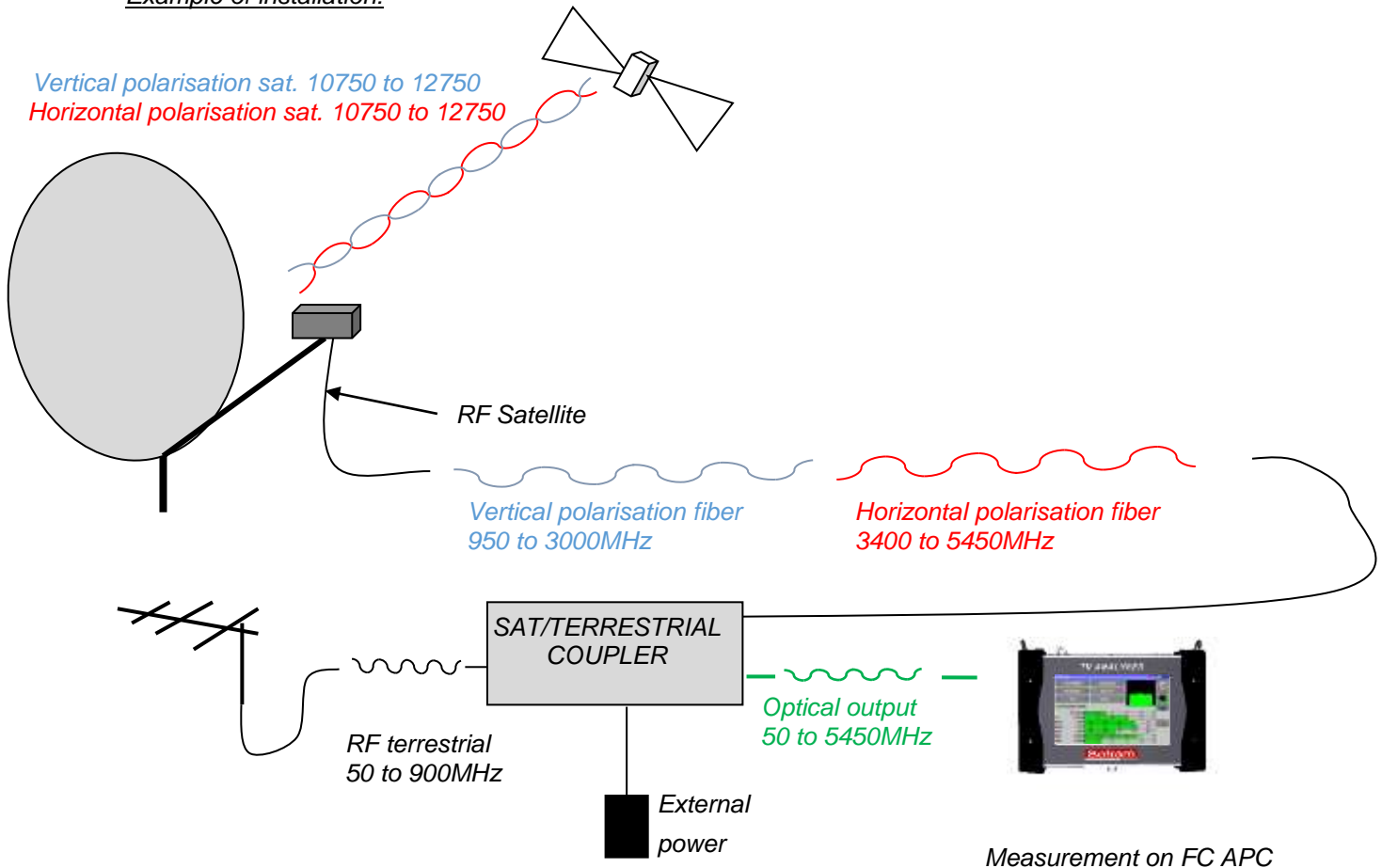

To display the signal at the output of your installation, you must connect the RF output of the optical option to the RF input of the appliance via the provided angled F/F cable. Power your coupler (no external power supply is provided with the measurement appliance).

Remove the protective plug from the FC APC optical socket; if required, use the provided jumper cable, and connect the optical fiber from your dish to the same socket.

Then, you can turn your dish (see chapter [2.2.3 Installation of a dish](#)) and/or your terrestrial antenna (see chapter [2.2.2 Installation of a terrestrial antenna](#)).

Once the measurements are made, **put the plug onto the optical socket** of the appliance.



Warning :

- Optical Power measurement between -50 / +10 dBm
- Optical conversion -> RF between -12 / -3 dBm

Use an external optical attenuator if necessary.

19 Configuration

For configuration, go to the Home page, then Configuration

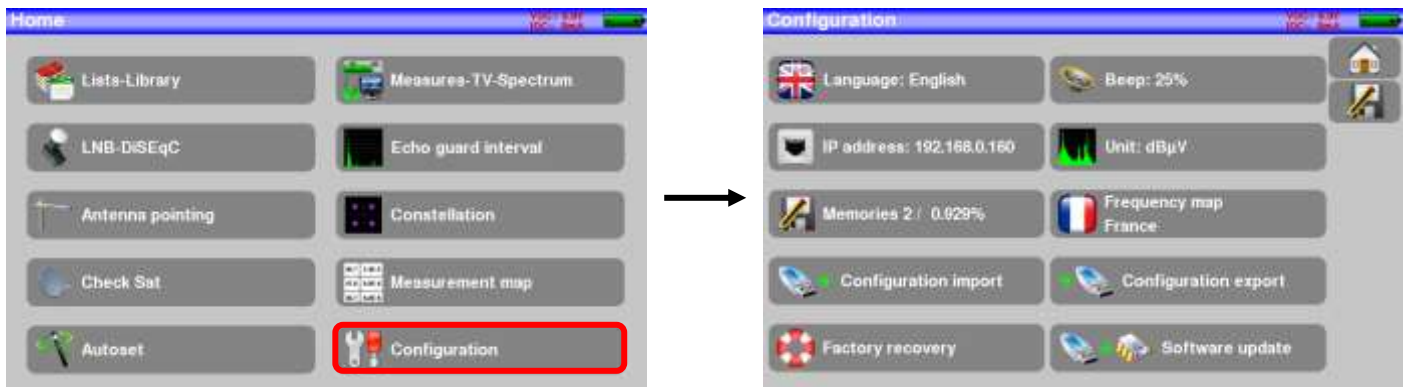

19.1 Language

You can select your language by pressing the « flag » (below). Press the flag corresponding to your language:



19.2 Measurement unit

This key allows you to select the measurement unit of the appliance:

- **dBµV:** 0 dBµV corresponds to 1 µV
- **dBmV:** 0 dBmV corresponds to 1 mV
- **dBm:** 0 dBm corresponds to 274 mV: 1 mW with a 75 Ω impedance.

19.3 Frequency map

This key allows you to select the terrestrial frequency map of the appliance:



An additional frequency plan is available: "USER"

You can set up your own Frequency Plan by the following procedure:

1/ create a CSV file named "PLANF.CSV"

For example, in Excel, create a file as below, then save as "PLANF.CSV":

	A	B
plan name (20 char maximum)	German Cable	
country code ISO 3166 (2 char)	DE	
1 line per channel :		
1st column : channel's name (8 char maximum)	D114	114
2nd column : channel's frequency (MHz)	D122	122
	D130	130
	D138	138
	D146	146
	D154	154
	D162	162
	D170	170
	D178	178
Maximum 120 channels	D186	186

2/ copy this "PLANF.CSV" file to a USB key at the root of the key

3/ insert the key on your device

4/ select "CONFIGURATION" "CONFIGURATION IMPORT" "confirm"

➔ your personalized frequency plan has taken the place of the plan previously named "USER"

19.4 Memories

To save a picture or any other feature, see chapter [Save](#)

The number of saved file and their memory size are displayed.



When pressing this key, a pull-down menu lists the previously saved files.

The first column contains the order number of the file; the second column contains the name of the file; the last column contains the type of file: Measure, Spectrum, Measurement map...

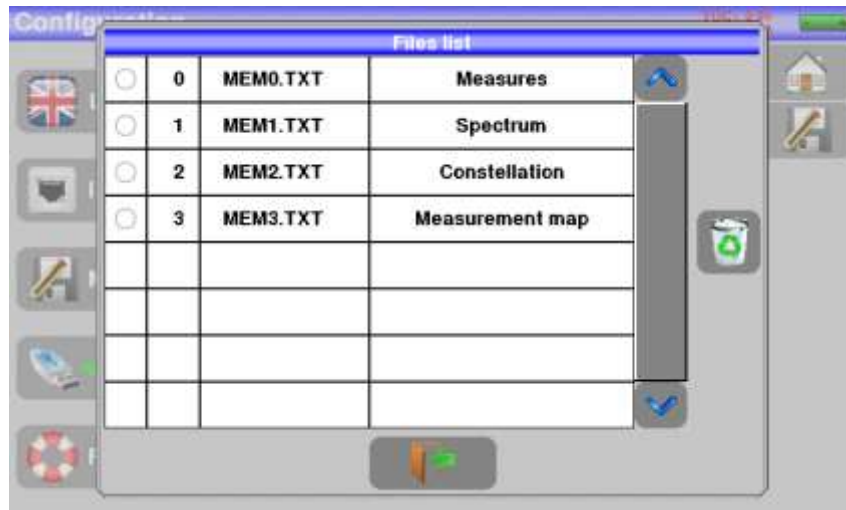

By pressing a line of the table, you open a window:

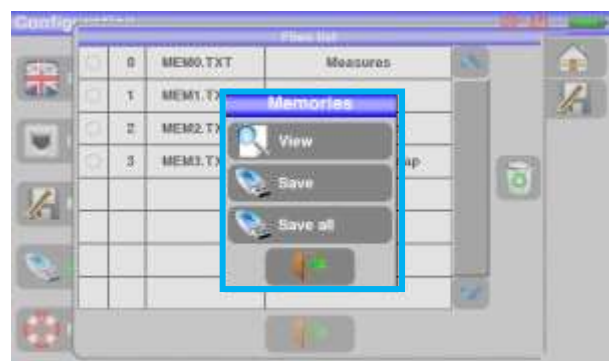
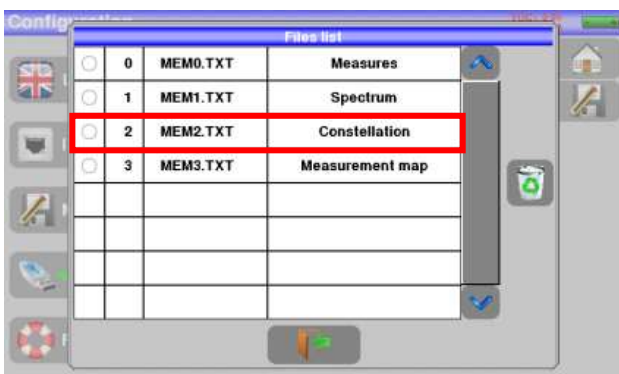

19.4.1 View

This key allows the display of the content of the file:

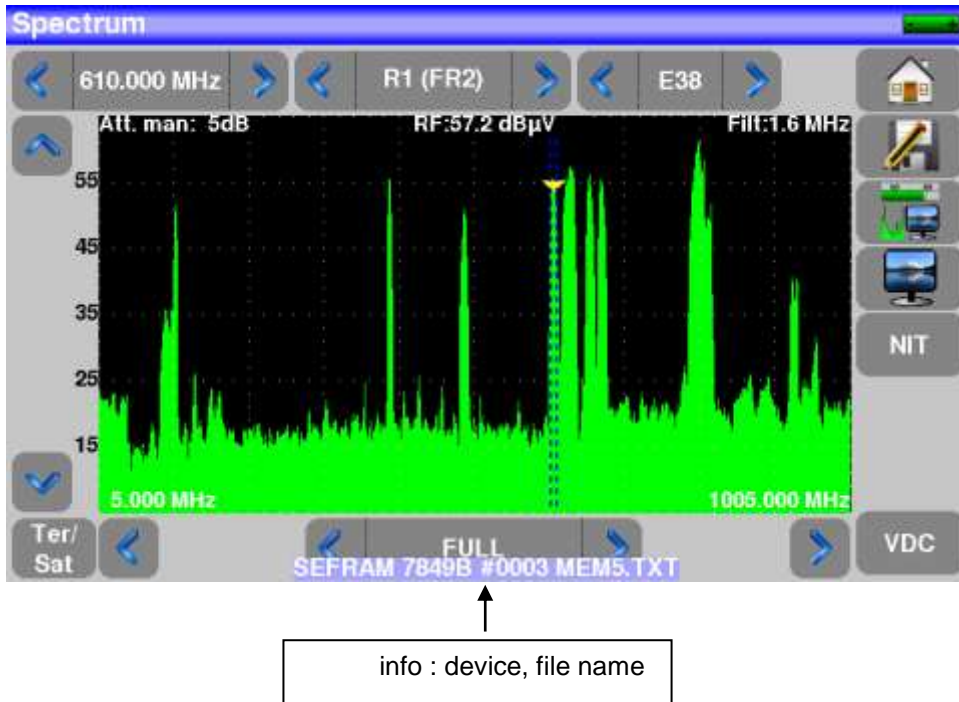

19.4.2 Save

- **Save (BMP -> USB)** allows you to export the file to the USB stick under BMP format (non-compressed graph); it is useful to transfer graphs to a report in a PC computer.

Here is the BMP file of the previously displayed DVB-T/H channel, edited on PC to have the spectrum full screen.

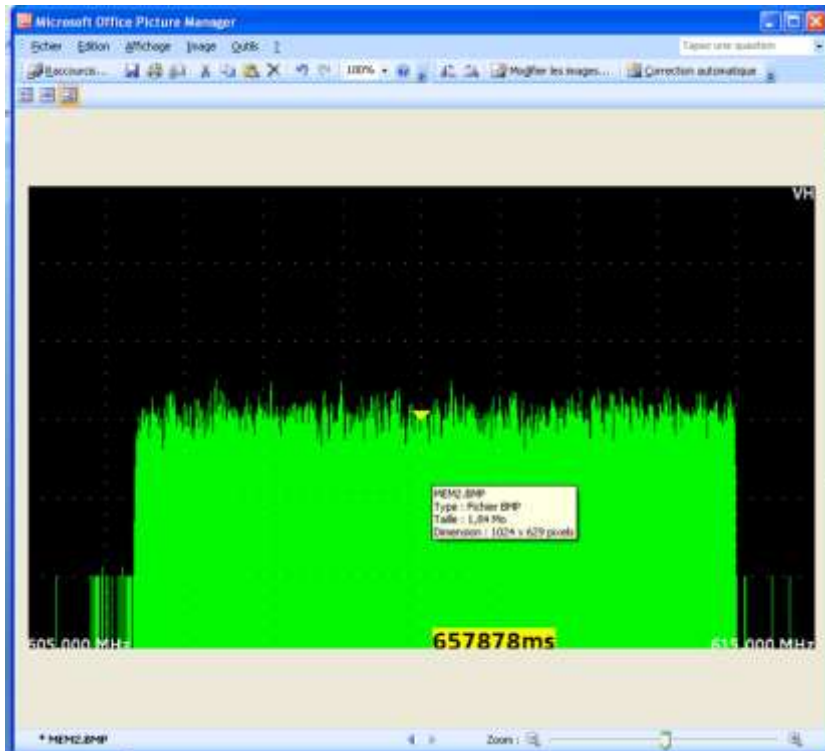

- **Save (CSV -> USB)** allows you to export the file to the USB stick under CSV format (text file by columns separated with semicolons); it is useful to analyze values in a spreadsheet.

Here is the spectrum here above with a curve under EXCEL™.

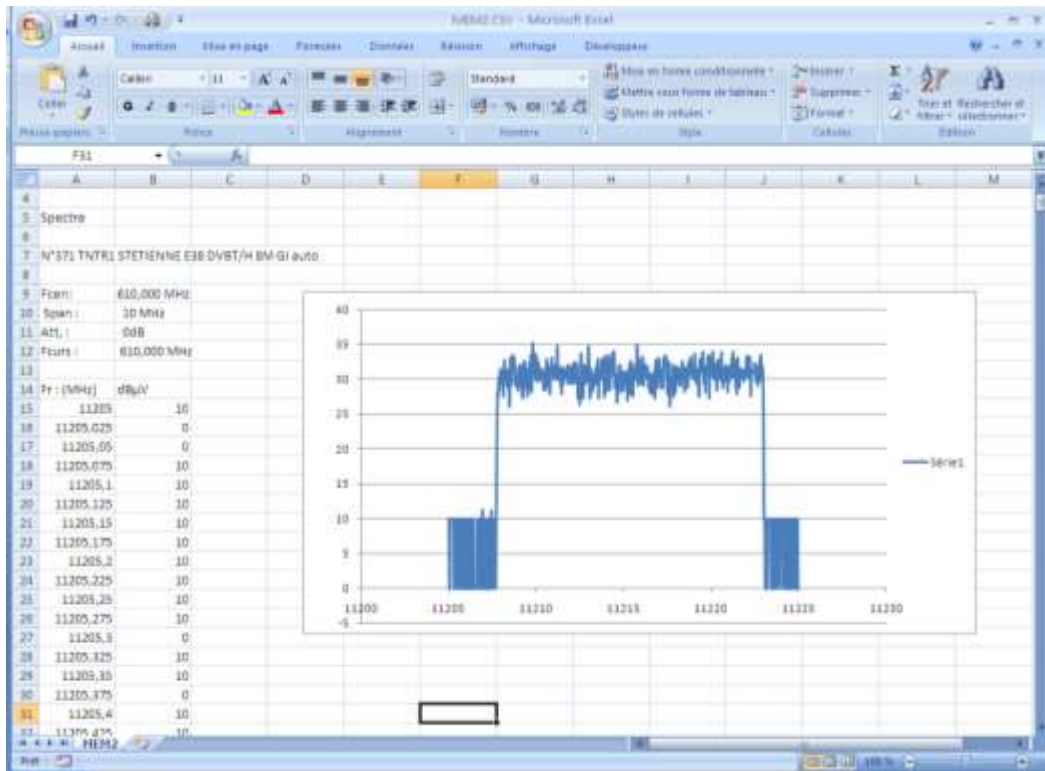

- **Save all (BMP -> USB)** records all files from the appliance under BMP format into separated registers:
 - LEVEL for the level measurements
 - MAP for the measurement maps
 - SPECTRUM for the spectrum measurements
 - BER-MER for the error rate measurements
 - CONST for the constellations
 - ECHO for the echoes.
- **Save all (CSV -> USB)** also records all files from the appliance into separated registers, but under CSV format.

19.4.3 Update

See chapter [Software update](#) for more details.

19.5 Factory recovery

A complete set-up of the appliance under its FACTORY configuration, with confirmation

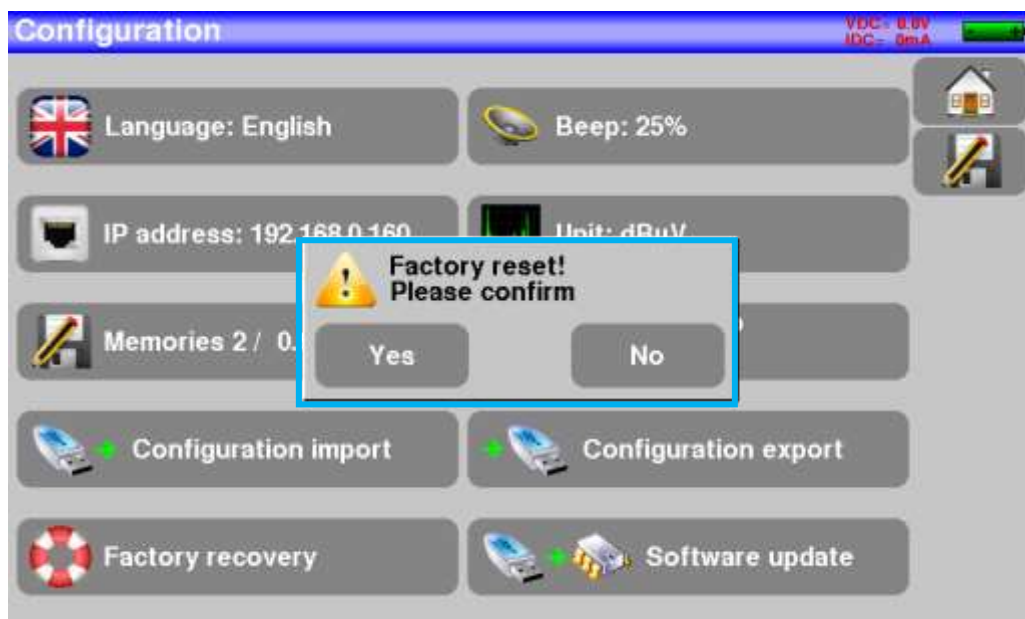

Attention: In case of factory recovery, you **lose**:

- the setup library
- the measurement lists

19.6 Configuration import/export

You can make a backup on a USB stick of your setups/lists of your appliance by pushing « « Configuration Export ».

And you can import from a USB stick this configuration with the touch “Configuration import”. You can also update checksat/antenna pointing configuration available on SEFRAM’s website:

http://www.sefram.com/Maj_soft/Sat.csv

20 Software update

You can easily update the software to get new functionalities.

The update requires an USB stick.



Attention: Take care that the remaining battery life is sufficient (> 30%), else plug the appliance on the mains with the provided adapter.

To achieve the update:

- Download the update file **784X_VX.X fichier zip** on our website (www.sefram.com)
- Insert a USB stick on your PC
- Unzip the file onto the root of the memory stick
- Pull the USB stick off from your computer
- Turn your appliance on
- Go to the Home page,  press configuration  Configuration
- Insert the USB stick into the connector of the appliance.
- Select Update: 



Attention: Do not turn the appliance off while updating

The updating process lasts ca. 10 minutes. At the end of the update, the appliance asks you to restart the appliance. The software is then loaded into your appliance.

Error messages may show up: **Do not take care of them.**

21 Save

Pressing  opens a window (here, on the Measurement page):



In this window, you can save the current measurement parameters from the active list, make a screenshot to a USB stick under BMP format or make a save into internal memory.

You can rename the save file.

The default name of the save is MEM(X+1) (X is the number of saves in the appliance).

You will be suggested a save into internal memory only in the **Spectrum**, **Measurements**, **Constellation**, **Guard interval** and **Measurement map** pages.



After transfer, you will be able to use the saved measures to create measurement reports on your computer (see paragraph [Saves](#) for more details).



When you stop the appliance, it may need a few seconds to stop completely because the save on flash memory is carried out during the extinction.

22 Connection of the appliance to a PC

The appliance has an **ETHERNET** interface that makes it possible to connect directly to a PC.

For this type of connection, no driver is necessary.

Connect your appliance to your PC by using a crossed ETHERNET cable (available in option with the number 298504246 asking SEFRAM).

- **Configuration of the connection:**

Ethernet connection of your appliance to the PC.

To change the IP address of your appliance, press  and:

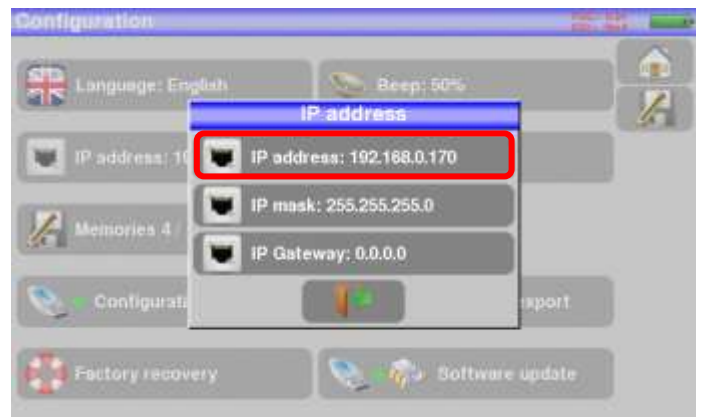

With the virtual digital keypad, type the IP address you want, then validate with ENTER

The PC software in communication with the appliance must have the same IP address as the appliance, just like in the example below:

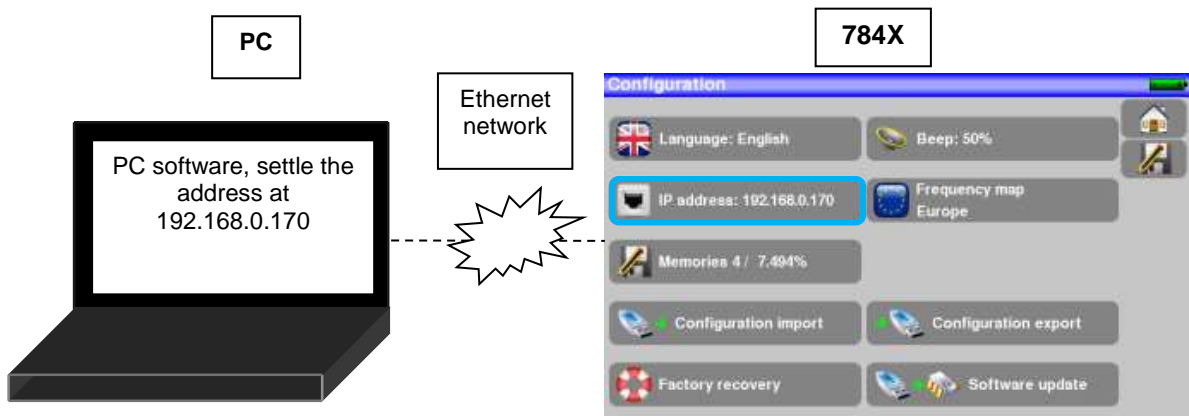



Attention: If the PC has already been connected to Ethernet (network, modem...), it is necessary to reboot the PC before connecting your appliance.

For the **Ethernet** connection of your appliance to a computer network, see the following scheme:

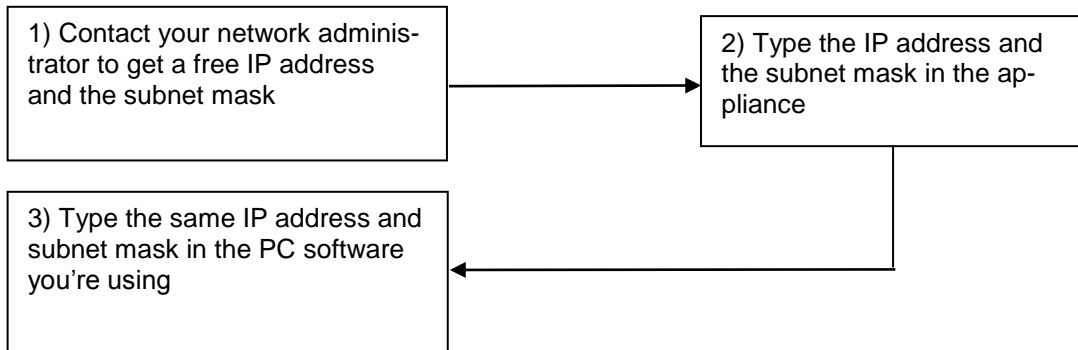

23 Displayed messages

The appliance may display messages while working.

23.1 Alert messages

Low battery: the appliance is about to shut off in a few minutes.



Confirmation request for an important action.



Remote power supply issue: voltage already present or maximum current exceeded.



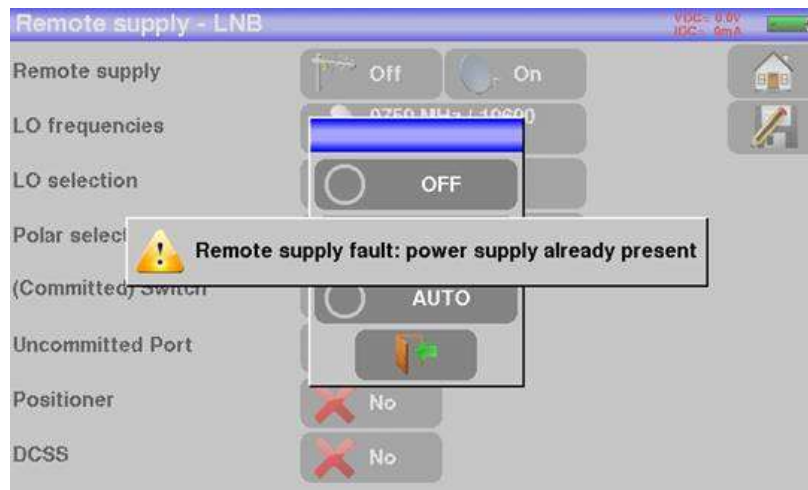

Messages of the same kind may show up; the pop up window is an alert; the corresponding message explains the issue.

23.2 Error messages

A message may show up at the bottom of the screen immediately after updating the software.

Do not take care of as far as it does not show up at a second start-up.

Else, or for any other problem, contact the **SEFRAM** technical support:

- **e-mail** : support@sefram.com
- **Téléphone** : **04 77 59 01 01**

24 Maintenance

This appliance requires some maintenance to meet its requirements and maintain its general characteristics.

	Consequences	Recommended periodicity of controls	Recommended use limit
BATTERY	Reduction of the battery life		200 charge / discharge cycles or 2 years
STRAPS	Breakdown	At each use Check the holding of the straps	
Back Light SCREEN	Reduction of visibility		1 year
MEASUREMENTS : adjust / check	Erroneous measures	Once a year	12 months
CONNECTIONS	Erroneous measures	At each use, check the state and cleanliness of the RF input	
Optical fiber patchcord	Erroneous measures	At each use, check the state and cleanliness of the patchcord	

This "advice" does not engage the responsibility of SEFRAM.

It guarantees the best possible use of the characteristics and the preservation of the product.

Routine maintenance:

The basic maintenance is simply cleaning the outside of the appliance. Any other operation requires a trained personal.

Unplug the appliance before any intervention.

Do not let water flow inside the appliance: risk of electric shock.

Regularly clean the appliance under the following conditions:

- use soapy water
- never use any product containing petrol, benzene, alcohols that would attack silkscreen printings
- wipe out with a soft lint-free cloth
- use a solvent-free antistatic product to clean the screen.

RF socket :

- Make sure there are **no specks of copper between the weight and the mass.**
- Replace periodically the adapter F/F, an adapter in poor condition distorts all the measures.

Optical:

- *Before connecting a fiber, it is necessary to clean both connectors with a compressed air spray. Never use clothes, alcohol, water or any other liquid or solvent.*

INFORMATION ABOUT THE LCD COLOR SCREEN WITH ACTIVE MATRIX

Your SEFRAM field strength meter is equipped with a LCD color screen with active matrix.

This screen is provided by renowned manufacturers. In the current technical conditions of manufacture, they cannot guarantee 100% good functioning pixels in the display zone. They specify a number of possible defective pixels at the surface of the screen.

The SEFRAM quality service has preconditioned the mounting of the screen on your instrument to the respect of the acceptance conditions of the manufacturers.

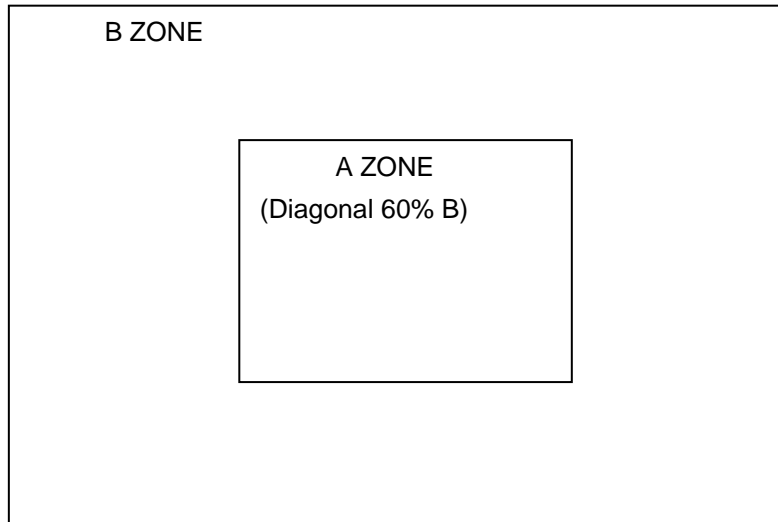

Acceptance criteria:

Zone A (central zone): total less than 5 defective pixels, less than 3 contiguous pixels.

Zone B (total surface of the screen): less than 9 defective pixels on the whole surface of the screen, with respect of the conditions prevailing in zone A.

Is considered as defective any pixel on screen that does not light up or lights up in a different color as expected.

The contractual guarantee on your field strength measurer can be exerted only if these criteria are not met, as well at delivery as during the period of guarantee.

25 Technical specifications

25.1 Selection guide

	7849B	7859B	7817B
Frequencies	5-2400MHz	5-2400MHz	5-1005MHz
DVB-T/T2/T2 Lite	✓	✓	✓
DVB-C/C2	✓	✓	✓
DVB-S/S2, DSS, Multistream	✓	✓	
DVB-S2X	○	○	
MPEG2/4, SD/HD	✓	✓	✓
A/V analog video input	✓	✓	✓
Spectrum analyzer	✓	✓	✓
Display TV, PID, NIT	✓	✓	✓
Constellation DVB-T/T2	✓	✓	✓
Multipath DVB-T/T2	✓	✓	✓
Terrestrial antenna pointing	✓	✓	✓
Satellite dish pointing, single and dual-LNB	✓	✓	
Optical Fiber measurements		✓	
Terrestrial Remote Power Supply	✓	✓	✓
Satellite Remote Power Supply – DISEQC	✓	✓	
SATCR EN50494, DCSS EN50607	✓	✓	
Ethernet	✓	✓	✓
USB	✓	✓	✓

- ✓ Fonction présente
- Fonction absente
- Option

25.2 Technical specifications

Technical specifications	Terrestrial band	Satellite band
Frequencies		
Range	5-1005 MHz	200-2400 MHz
Resolution	measurement 50 kHz, display 1 kHz	measurement 1MHz, display 1MHz
Level measurements		
Dynamic range	20-120 dB μ V	20-120 dB μ V
Units	dB μ V, dBmV, dBm	
Accuracy	2dB +/- 0.05dB/°C	
Resolution	0,1dB	
Measurement Filters	32 kHz	160 KHz
Standards	DVB-T/T2/T2lite, DVB-C/C2, DAB BG, DK, I, L, MN, carrier	DVB-S/S2/S2X, DSS PAL, SECAM, NTSC, carrier
Mesures	RF level/power, C/N	
Spectrum Analyser		
Span	1 MHz to full span 1, 2, 5 step	
Speed	100 ms mini, 1000 ms maxi	
Filters (according to span)	1.6kHz, 3.2kHz, 8kHz, 16kHz, 32kHz, 80kHz, 160kHz, 320kHz, 800kHz, 1.6MHz, 3.2MHz	
Attenuator	automatic or manual (0 to 55 dB with 5 dB step)	
Dynamic range (display)	60 dB (10 dB/div)	
Multipath DVBT/T2/C2		
Dynamic range	DVB-T : 50 dB, -75km +75km (8k) DVB-T2 : 50 dB, -75km +75km (8k) DVB-C2 : 50 dB, -35km +35km (4k)	
Units	μ s, km, miles	
Constellation display		
	yes, standards DVB-T/T2/T2 Lite, DVB-C/C2, DVB-S/S2/S2X, DSS	
Measurement Map		
Capacity	scanning of 50 setups maximum	
Display	Texte table	
TV MPEG		
Digital Multiplex (not crypted)	MPEG2 SD (standard definition) MPEG4 HD (high definition H.264)	
Service table DVB-SI	SDT, LCN	
Sound	MPEG-1, MPEG-2, AAC, HE AAC, Dolby® Digital, Dolby® Digital Plus	

25.3 Digital measurements

DVB-T	
Bit Error Rate (BER)	CBER (before Viterbi BERi) VBER (after Viterbi BERo) UNC (lost packets PER) Noise margin
Modulation Error Rate(MER)	15 - 35dB
Sensitivity	< 35dB μ V
Bandwidth	6MHz, 7 MHz, 8 MHz
FFT type	2k, 8k
Constellation	QPSK, 16QAM, 64QAM
Viterbi rate	1/2, 2/3, 3/4, 5/6, 7/8
Guard interval	1/4, 1/8, 1/16, 1/32
Spectrum inversion	auto
HP/LP – PLP – Data Slice	HP/LP
Standards	ETS 300-744

DVB-T2 / T2 Lite	
Bit Error Rate (BER)	LDPC (BERi) BCH (BERo) FER (frame error PER) Noise margin
Modulation Error Rate(MER)	15 - 35dB
Sensitivity	< 35dB μ V
Bandwidth	1.7MHz, 5MHz, 6MHz, 7 MHz, 8 MHz
Mode	SISO, MISO, PLP single or multiple
FFT type	1k, 2k, 4k, 8k, 16k, 32k + extended bandwidth
Constellation	QPSK, 16QAM, 64QAM, 256QAM
Guard Interval	1/4, 1/8, 1/16, 1/32, 1/128, 19/128, 19/256
Spectrum inversion	auto
HP/LP – PLP – Data Slice	PLP
Standards	ETS 302-755

7849B – 7859B – 7817B

DVB-C J83A	
Bit Error Rate (BER)	BER (before Reed Solomon BERo) UNC (lost packets PER) Noise margin
Modulation Error Rate(MER)	20 - 40dB
Sensitivity	< 55dB μ V
Symbol Rate	1 to 7.224 Ms/s
Constellation	16 / 32 / 64 / 128 / 256 QAM
Spectrum inversion	auto
Standards	ETS 300-429

DVB-C2	
Bit Error Rate (BER)	LDPC (BERi) BCH (BERo) FER (frame error PER) Noise margin
Modulation Error Rate(MER)	25 - 35dB
Sensitivity	< 55dB μ V
Symbole rate	-
Bandwidth	6MHz, 8 MHz
Mode	PLP and data slice, single or multiple
FFT type	4k
Constellation	16 / 64 / 256 / 1024 / 4096 QAM
Guard interval	auto
Spectrum inversion	auto
HP/LP – PLP – Data Slice	PLP + Data Slice
Standards	ETS 302-769

7849B – 7859B – 7817B

DVB-S, DSS	
Bit Error Rate (BER)	CBER (before Viterbi BERi) VBER (after Viterbi BERo) UNC (lost packets PER) Link margin
Modulation Error Rate(MER)	0 - 20dB
Sensitivity	< 47dBμV
Symbol rate	1 to 50Ms/s
Constellation	QPSK
Viterbi rate	1/2, 2/3, 3/4, 5/6, 7/8
Spectrum inversion	Auto
Standards	ETS 300-421

DVB-S2	
Bit Error Rate (BER)	LDPC (BERi) BCH (BERo) PER Link margin
Modulation Error Rate(MER)	0 - 20dB
Sensitivity	< 47dBμV
Symbol rate	1 to 50Ms/s
Constellation	QPSK, 8PSK, 16APSK, 32APSK
Modulation	CCM, VCM
Code LDPC	QPSK : 1/2, 2/3, 3/4, 3/5, 4/5, 5/6, 8/9, 9/10 8PSK : 2/3, 3/4, 3/5, 5/6, 8/9, 9/10 16APSK : 2/3, 3/4, 4/5, 5/6, 8/9, 9/10 32APSK : 3/4, 4/5, 5/6, 8/9, 9/10
Roll-off	0.20, 0.25, 0.35
Spectrum inversion	auto
Standards	ETS 302-307 Part 1

DVB-S2X	
Bit Error Rate (BER)	LDPC (BERi) BCH (BERo) PER Link margin
Modulation Error Rate(MER)	0 - 20dB
Sensitivity	< 47dBμV
Symbol rate	1 à 50Ms/s
Constellation	QPSK, 8PSK, 8/16/32APSK, 8/16/32APSK-L
Modulation	CCM, VCM
Code LDPC	QPSK : 13/45, 9/20, 11/20 8PSK : 23/36, 25/36, 13/18 16APSK : 26/45, 3/5, 28/45, 23/36, 25/36, 13/18, 7/9, 77/90 32APSK : 32/45, 11/15, 7/9 8PSK-L : 5/9, 26/45 16APSK-L : 1/2, 8/15, 5/9, 3/5, 2/3 32APSK-L : 2/3
Roll-off	0.05, 0.10, 0.15, 0.20, 0.25, 0.30, 0.35
Spectrum inversion	auto
Standards	EN 302-307 Part 2

MULTISTREAM	
ISI (stream number)	0 to 255
PLS (scrambling)	yes
Gold code	0 to 999999

25.4 Optical measurements (7859B)

Optical fiber input	
Wavelengths	1310nm, 1490nm, 1550nm
Connector	FC/APC
Optical power measurement	
Measurement dynamic	-50.0dBm to +10dBm
Accuracy	+/- 0.5dB
Optical to RF converter	
Conversion dynamics	-12dBm to -3dBm
Input optical bandwidth	50MHz to 5450MHz
Converted RF terrestrial bandwidth	50 to 900MHz
Converted RF satellite bandwidth	950MHz to 2150MHz

25.5 Divers

Remote supply	Terrestrial	Satellite
Voltage	5V/13V/18 V/24V 500 mA max (300mA for 24V)	13/18 V 500 mA max
DiSEqC	-	DiSEqC 2.1 control of dish motor switches committed & uncommitted bi-directionnal
Mini DiSEqC (22kHz)	-	22 kHz, ToneBurst
SCD /SATCR EN 50494 Single cable satellite distribution	-	8 slots max automatic detect (pilots detect)
SCD2 EN 50607 Single cable satellite distribution v2	-	32 slots max code PIN, adjustable slot bandwidth automatic detection (bi-directionnal Diseqc)

Storage	
Memory	Internal on non-volatile memory, or external USB stick (not supplied)
Data saved	measurements (level, BER/MER, Measurement Maps, Spectrum,...)
Capacity	512 Ko (about 150 files)

Inputs / Outputs	
RF input	75 Ohms, F male possible adaptators F-F, F-BNC, F-IEC maximum available voltage : 50V DC, 33V RMS / 50Hz
A/V analog video input	JACK 3.5mm, multipole 4 poles video : 75 Ohms, 1Vpp max audio : 10 kOhms
Interfaces	USB A, Ethernet 10/100baseT (RJ45)
DC supply input	jack 5.5 mm 15 V max, 1 A max

25.6 General specifications

Display	LCD TFT 7 inch color 16/9, luminosity backlight 500 cd/m ² , 800x480 dots Touch capacitive			
External supply	Main adaptator 110/230 VAC, with 5,5mm jack, 15 V 1 A			
Battery	Batterie Li-ion 33W		Batterie Li-ion 93W	
Autonomy (1)	terrestrial DVB-T no remote supply 2H typical	satellite DVB-S2 with remote supply 13v/180mA 1H30 typical	terrestrial DVB-T no remote supply 6H typical	satellite DVB-S2 with remote supply 13v/180mA 4H30 typical
Charging time (device off)	2H for 80% of capacity 3H for 100% of capacity		9H for 80% of capacity 10H for 100% of capacity	
Operating temperature	-5°C to 40°C			
Charging temperature	0°C à 35°C			
Storage temperature	-10°C to 60°C			
EMC and safety	NF EN 61326-1(2013) et NF EN 61326-2-1(2013) class B, basic electromagnetic environment NF EN 61010-1			
Dimensions	250 x 165 x 65 mm			
Weight	1,350 kg		1,650 kg	

(1) The autonomy is set at 25°C, with the brightness of the screen decreased, with and without Remote power supply, no interface connected and 10% sound

25.7 Accessories

Supplied with: main adaptor, battery, user's manual (CD-ROM), F/F adaptor, protective pouch with belt.

Optional accessories:

- RF input adapter F/F réf. 213200014
- RF input adapter F/BNC réf. 213200015
- RF input adapter F/IEC female réf. 213200017
- A/V analog video patchcord réf. 978853000
- DVB-S2X demodulation réf. 978484000
- Car cigar lighter adaptor ref. 978361000
- Carrying bag ref. 978481000
- Luxury backpack réf. 978751000
- Optical fiber patchcord FC-PC / PC-APC réf. 978754700
- Optical fiber patchcord FC-APC / SC-APC réf. 978754710
- Sun protector + Rain protector + coat hook ref. 978489000
- Sun protector réf. 978489650
- Rain protector réf. 978489500

Contact SEFRAM's sales department.

04 77 59 01 01

25.8 dB μ V, dBmV et dBm conversion

- dB μ V is a logarithmic ratio between a measured voltage U_d and a reference voltage U_r .

The reference voltage is $U_r = 1 \mu\text{V}$

$$N = 20 \log (U_d/U_r)$$

- dBmV is a logarithmic ratio between a measured voltage U_d and a reference voltage U_r .

The reference voltage is $U_r = 1 \text{ mV}$

$$N = 20 \log (U_d/U_r)$$

- dBm is a logarithmic ratio between a measured power P_d and a reference power P_r .

The reference power is $P_r = 1 \text{ mW}$ into 75 ohms.

$$N = 10 \log (P_d/P_r) \text{ with } P_d = U_d^2 / 75$$

$U_d = 1 \mu\text{V}$	$N = 0 \text{ dB}\mu\text{V}$	$N = -60 \text{ dBmV}$	$N = -108.75 \text{ dBm}$
$U_d = 1 \text{ mV}$	$N = 60 \text{ dB}\mu\text{V}$	$N = 0 \text{ dBmV}$	$N = -48.75 \text{ dBm}$
$U_d = 1 \text{ V}$	$N = 120 \text{ dB}\mu\text{V}$	$N = 60 \text{ dBmV}$	$N = 11.25 \text{ dBm}$

25.9 Typical values for measurements

Values given are indicatives, minimum and maximum for good signal quality

Measurements	Level, power (dB μ V)		C/N (dB)	BER	MER (dB)	modulation
	mini	maxi				
Terrestrial						
Analogue TV	57	74	> 45	-	-	-
FM	50	66	> 38	-	-	-
DAB/DAB+	35	70		BER < 2 ^{E-4}	-	2K
DVB-T	35	70	> 26	VBER < 2 ^{E-4}	> 26	8K, 64QAM, 1/32, 2/3
DVB-T2	35	70	> 22	FER < 2 ^{E-7}	> 22	32K, 256QAM, 1/8, 2/3
DVB-C	57	74	> 31	BER < 2 ^{E-4}	> 31	64QAM
Satellite						
DVB-S, DSS	47	77	> 11	VBER < 2 ^{E-4}	> 11	QPSK, 3/4
DVB-S2/S2X	47	77	> 8	PER < 1 ^{E-7}	> 8	8PSK, 2/3

26 Terminology

2K/8K : The number of carrier waves of the DTT channel

The **8K** mode (6817 carrier waves in the channel, including 6048 carrying useful data)

The **2K** mode (1705 carrier waves in the channel, including 1512 carrying useful data)

For the same purpose, the 8K mode allows the selection of a larger guard interval than the 2K mode, thus a better resistance to echoes

SPECTRAL ANALYSIS : Method used to highlight the characteristics of the signal. The interest of this analysis is to visualize the troublemakers as well as the shape of the signal. The spectrum analysis highlights the amplitude frequency characteristic.

FREQUENCY BAND : Continued portion of the frequency spectrum having made the object of a particular affectation (telecommunication, television, internal security...)

Exemple : UHF band → 470 to 860 MHz

BCH : Bose Chauhuri Houquenoem

Algorithm used to correct errors in transmissions of digital satellite DVB-S2 signals.

BER : Bit Error Rate

Calculation of the erroneous bits with regard to the number of transmitted bits. BER demonstrates the degradation of the digital information.

TV PACKAGE : Set of channels spread and marketed by a same operator (TPS, Cnal Satellite...)

CHANNEL : Assignment of a number to the transmission frequency of an audio video signal. TV channels receive numbers. Specific to each country.

Example : from 21 to 69 for the UHF band

canal 21 = frequency 471,25 MHz

CELL ID: Cell identification

Identification of the DVB-T emitter with 4 digits in hexadecimal format, which means 65536 possibilities.

C/N : Carrier to Noise ratio

A good C/N ratio helps the quality of the pictures on the TV screen. Ratio in dB.

Caution: You have to take the ratio analysis filter width / channel into account.

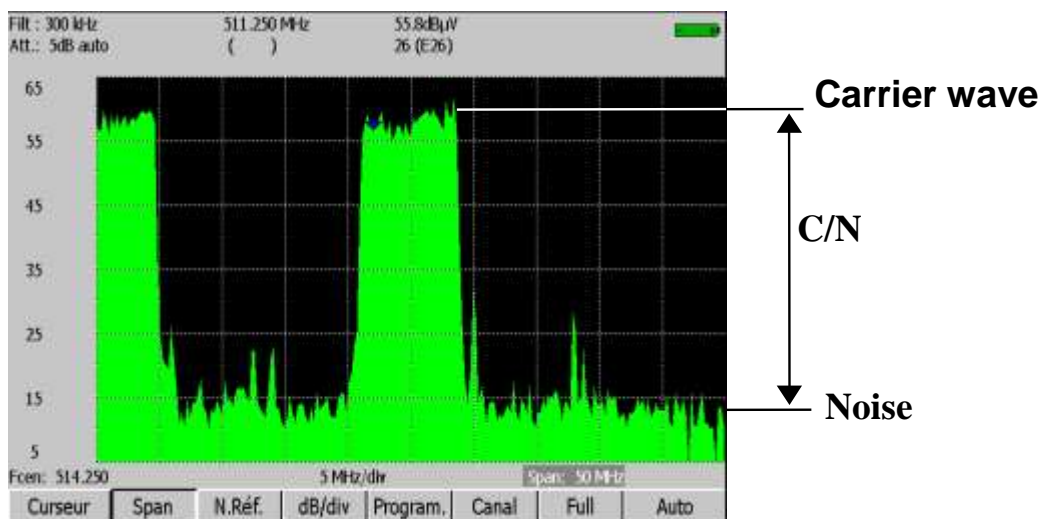

COFDM: Coded Orthogonal Frequency Division Multiplex.

Digital coding used for DTT. Its principle is to transmit information via many carrier waves (2K or 8K mode).

CONSTITUTION: Control mean for the quality of the signal by a group of points making spots on the screen of the field meter. **The more circular and distinct the spots of the constellation, the better the quality of the signal.** In addition, according to the shape of the spots, you can evaluate the kind of error. This function is available on field meters that enable the display of the constellation for any type of digital signal QAM, QPSK and COFDM.

Typically:

- QAM (cable) : 64 spots (16 spots per quarter)
- COFDM (TNT) : 64 spots (16 spots per quarter)
- QPSK (Satellite) : 4 spots (1 spot per quarter)
- 8PSK (Satellite) : 8 spots (on a circle)

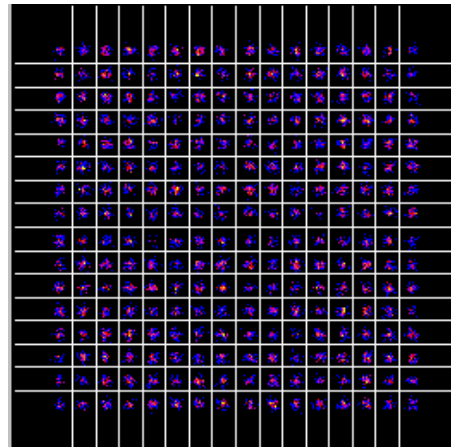
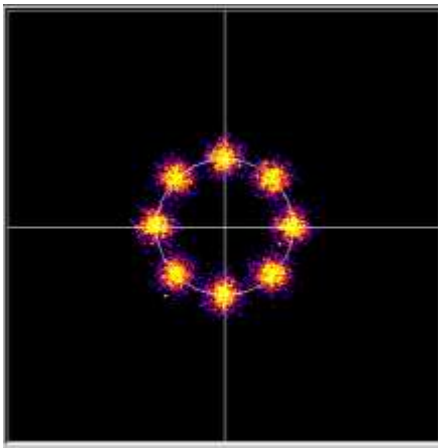

COUNTER-POLARIZATION: Ratio between the levels received from the desired polarization and the opposed polarization (it should be as high as possible). To adjust the counter-polarization, you have to turn the head of the dish.

DAB: Digital Audio Broadcasting.

The Digital Audio Broadcasting is a standardized audio broadcasting system (coded in COFDM).

It exists on the following bands:

L Band: 1452-1492Mhz

3 Band: 223-230Mhz

DVB-T: Broadcasting norm for the terrestrial digital television, COFDM modulation

DVB-C: Broadcasting norm for the cable digital television, QAM modulation

DVB-C2: Broadcasting norm for the cable digital television by cable (based on DVB-T2)

DVB-S: Broadcasting norm for the satellite digital television, QPSK modulation

DVB-S2: Broadcasting norm for the satellite digital television, QPSK or 8PSK modulation

DISEqC: Digital Satellite Equipment Control.

Control norm for the equipment of reception for satellite signals. Uses a 22kHz signal superimposed to the remote supply voltage of the satellite dish.

FREQUENCY: Parameter that characterizes the radio-electrical wave. It is measured in "Hertz". We

usually use

some multiples of this unit: kilohertz (kHz), megahertz (MHz), gigahertz (GHz).

ex.: At Saint Etienne (Guizay), the TF1 frequency is 583.25 MHz

HPLP: high/low priority → possibility to transmit 2 multiplexes under the same channel in digit format (ex.: in COFDM, we have a very robust high priority flow in QPSK; secondary flow in 16QAM)

GUARD INTERVAL: The guard interval is the time when the signal is not emitted: all signals carrying the same information but coming from different sources (various emitters or through multiple reflections) won't disturb each other.

Value for DTT: 1/32 (28µs), that permits echoes lower than 8.4km

ISOFREQUENCY: (or SFN: Single Frequency Network)

A DVB-T emitter network that emits on a whole region or a country at the same frequency.

→ risk of echoes outside the guard interval

→ moving reception

LNB: Low Noise Block-converter

A LNB (or universal head) is a standard converter for the analogical and digital reception of a satellite.

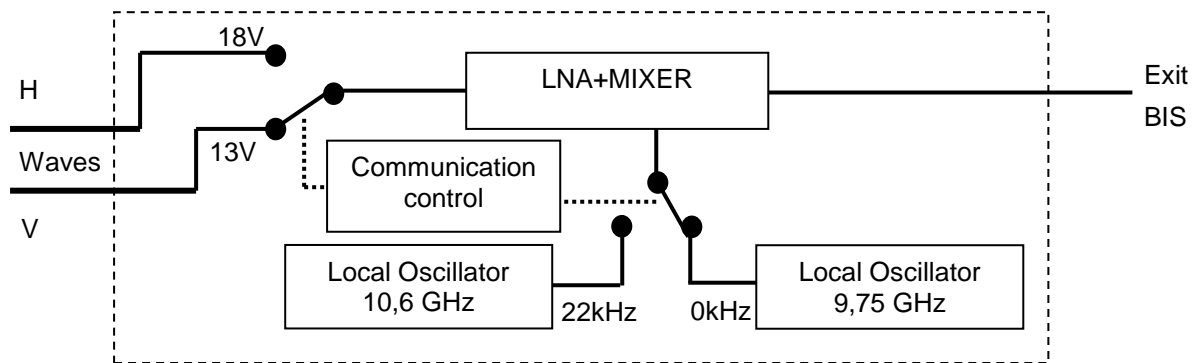

The reception is made on 2 low/high frequency band and 2 horizontal/vertical polarizations of the received wave.

The commutation of the band is made by a 13/18Volt voltage. The commutation of the polarization is made by a 22kHz signal superimposed to this voltage (you can also use the DiSEqC commutation for some LNB).

LDPC: Low Density Parity Checker

An algorithm used to correct errors in transmissions of digital satellite transmissions DVB-S2 signals.

NOISE MARGIN: Difference between the measured and the theoretical noise level before incorrigible errors.

Difference in dB between the measured C/N and the minimum C/N for error-free transmission.

MER: Modulation Error Ratio

Ratio in dB measuring the distance between the theoretical dot and the observed dot on a constellation quarter. You can use it to control the reception: **the higher this value, the better the image.**

 Error vector

 Magnitude vector (from the reference dot to the ideal dot)

MODULATION: Once the signal has been coded, it is modulated with a carrier wave for transmission.

AM (Amplitude Modulation): analogical modulation of the amplitude of the carrier wave

FM (Frequency Modulation): analogical modulation of the frequency of the carrier wave

QPSK (Quadrature Phase Shift Keying): phase digital modulation

QAM (Quadrature Amplitude Modulation): phase and amplitude digital modulation

COFDM (Coded Orthogonal Frequency Division Multiplex): phase and amplitude digital modulation on multiple carrier waves; for DTT.

MPEG : Motion Picture Expert Group

MPEG is a family of compressed digital coding formats for audio / video. The aim of MPEG coding is to hugely reduce the amount of transmitted information with as little loss as possible thanks to very complex compression algorithms.

The MPEG 2 option on the SEFRAM field meters allows you to view and control TV programs (coded under MPEG) directly on the meters.

ex.: On the Astra satellite, the EURONEWS and SPORT + channels are non-encrypted and visible on the field meters.

MULTIPLEX : Set of channels broadcasted by the same operator (smaller set than a package). In DTT, a multiplex has a 24.5Mbits/s flow rate. A multiplex enables the diffusion of 6 programs in standard definition

NIT : Network Information Table – Information about the network/package

Enables the display of a description of the measured transponder. The information is sent non-coded in the data flow from the QAM, COFDM or QPSK decoder. The information items are:

- Name of the operator
- List of the transponders of the package
- Orbital position of the satellite (in Satellite mode).

OFFSET: The central frequency of a DTT channel may be shifted by ± 166.7 kHz in case of adjacent analogical channel to prevent disturbances

OL: A local oscillator that converts the frequency received from the satellite, in GHz, into an intermediary frequency that the demodulator can use, in MHz.

ex.: a 11.778 GHz frequency from the satellite passing through a 10.6 GHz OL LNB becomes a 11.778-10.600=1.178 MHz

See LNB scheme.

AUDIO AND VIDEOPID: Packet Identifier. MPEG service information.

In the digital MPEG flow, the (audio or video) packets all include a PID to get binary data from each service.

Frequency plan: There are various Frequency Plans according to places and standards. In the SEFRAM

field meters, the frequency plans are pre-programmed: they gather the most frequently used frequency bands.

Measure plan : Allows the simultaneous view of characteristics (frequency, channel, standard...) of various programs (TF1, France2...) with location of measures except tolerance. Allows to carry out BER live measures, for a list of programs.

PLP : (Physical Layer Pipe) from 1 to 256 channels are available in DVB-T2 to transport independent multiplexes.

POLARIZATION: Polarization of a signal from the satellite. It can be either:

linearly polarized, horizontally or vertically:

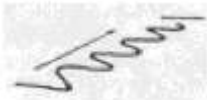
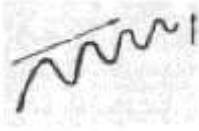

Circularly polarized to the right or the left

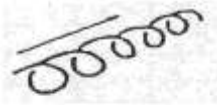

In ground reception, the polarization is generally horizontal (the stalks of antennas are horizontal). Some receptions in band VHF are in vertical polarization (Canal+). In this case, the stalks of the antenna are vertical.

POSITIONER: A motorized system for the rotation of a satellite dish. Positioners are operated by DiSEqC commands

QAM : Quadrature Amplitude Modulation.

This kind of modulation is used for digital transmissions (cable networks and DTT).

QPSK: Quadrature Phase Shift Keying (or 4PSK)

A kind of modulation mostly used for satellites.

8PSK : A type of modulation identical to QPSK, but with an 8-possibility (3-bit) coding. This kind of modulation enables higher rates than QPSK and is compatible with DVB-S2.

REED-SOLOMON : An algorithm used to correct errors in digital transmissions

STANDARD : Any norm that defines the characteristics of a modulation.

Analogical standards: L, BG, DK, etc.

Digital standards:

QAM for **cable television**

QPSK, 8PSK for **satellite television**

COFDM for **terrestrial digital television**

T-DMB : A digital broadcasting system based on the DAB.

This very robust broadcasting mode for mobile applications thanks to the modulation used (DQPSK=differential QPSK). Allows the reception of digital television but also of television programs on small-size appliances like mobile telephones or PDA

TOP DE SYNCHRO : Signal carré indiquant le début d'une trame ou d'une ligne.

TVHD : Télévision Haute Définition

En télévision standard, le nombre de lignes composant l'image va de 480(NTSC) à 576 (PAL et SECAM). Chaque ligne comprend 720 pixels. Pour comparer à l'informatique, un téléviseur correspond à une résolution SVGA 800 x 600. La proportion de l'image est de 4/3 (rapport largeur / hauteur).

En télévision HD, l'image est constituée de 1080 lignes, chacune constituée de 1920 pixels – soit un équivalent de 2M pixels.

Les téléviseurs HD ready ont une résolution minimale de 1280 par 720

Les téléviseurs Full HD ont une résolution minimale de 1920 par 1080

UNC : un-corrected packets

VIACCESS - MEDIAGUARD : Decryption systems used in Europe by many operators (TPS, Canal Satellite...).

With the Viaccess and Mediaguard options in a SEFRAM field meter and your subscription card, you will be able to view encrypted programs on the meter.

VITERBI : An algorithm used to correct errors in digital transmissions